



---

 This user manual describes all items concerning the operation of the system in detail as much as possible. However, it is impractical to give particular descriptions of all unnecessary and/or unavailable operations of the system due to the manual content limit, product specific operations and other causes. Therefore, the operations not specified herein shall be considered impossible or unallowable.

 This user manual is the property of GSK CNC Equipment Co., Ltd. All rights are reserved. It is against the law for any organization or individual to publish or reprint this manual without the express written permission of GSK and the latter reserves the right to ascertain their legal liability.

## FOREWORD

Dear user,

We are really grateful for your patronage and purchase of this **GSK980TDc Turning CNC system** made by GSK CNC Equipment Co., Ltd.

The user manual describes the programming, operation, installation and connection of this **GSK980TDc Turning CNC system**. Please read it carefully before operation in order to get the safe and effective working.

### Warning



This system can only be operated by authorized and qualified personnel as improper operations may cause accidents.

Please carefully read this user manual before use!

Note: The power supply installed on (in) the cabinet is exclusive to GSK'S CNC systems.

The power supply form is forbidden to be used for other purposes. Otherwise, there may be extreme danger!

This user manual shall be kept by final user.

## Notes

### ■ Delivery and storage

- Packing box over 6 layers in pile is unallowed.
- Never climb the packing box, neither stand on it, nor place heavy objects on it.
- Do not move or drag the product by the cables connected with it.
- Forbid collision or scratch to the panel and displayer.
- Packing box should be protected from damping, insulation and raining.

### ■ Open packing box to check

- Ensure things in packing box are the required ones.
- Ensure the product is not damaged in delivery.
- Ensure the parts in packing box are in accordance to the order.
- Contact us in time if the product type is inconsistent with the order, there is short of accessories, or product damage in delivery.

### ■ Connection

- Only qualified persons can connect the system or check the connection.
- The system must be earthed, its resistance must be less than 4  $\Omega$  and the ground wire cannot be replaced by zero wire.
- Connection must be correct and firm to avoid the product to be damaged or other unexpected result.
- Connect with surge diode in the specified direction to avoid the damage to the system.
- Switch off power supply before pulling out plug or opening electric cabinet.

### ■ Troubleshooting

- Switch off power supply before troubleshooting or changing components.
- Troubleshoot and then startup the system when there is short circuit or overload.
- Do not switch on or off it frequently and an interval is 1 minute at least after the system is powered on again.

### Announcement!

- This manual describes various items as much as possible. However, operations allowable or unallowable can not be explained one by one due to so many possibilities that may involve with, so the contents that are not specially stated in this manual shall be considered to be unavailable.

### Warning!

- Please read this user manual and a manual from machine builder completely before installation, programming and operation; do operate the system and machine according to user manuals, otherwise it may damage the system, machine, workpiece and even injure the operator.

### Cautions!

- Functions, technical indexes described in this user manual are only for the system. Actual functions and technical performance of machine tool with this CNC system are determined by machine builder's design, so refer to its user manual.
- The system is employed with integrated machine control panel and the keys on machine control panel are defined by PLC program. Functions of keys in this user manual are for standard PLC program. Please notice it!
- Refer to user manual from machine manufacturer about functions and meanings of keys on machine control panel.

All specification and designs are subject to change without further notice.

## **I Programming**

**GSK980TDc CNC Technical Specification, Product Type, Command and Program Format**

## **II Operation**

**GSK980TDc CNC Operation Use**

## **III Installation and Connection**

**GSK980TDc CNC Installation, Connection and Setting**

## **Appendix**

**CNC Ladder Function Allocation, Alarm Message Table**

## Safety Responsibility

### Manufacturer's safety responsibility

- The manufacturer should be responsible for the cleared or the controlled safety in the design and the structure of the CNC system and the accessories.
- The manufacturer should be responsible for the CNC system and the accessories.
- The manufacturer should be responsible for the message and the suggestion for the user.

### User's safety responsibility

- The user should study and train the system safety operation, master the safety operation content.
- The user should be responsible for the danger caused by increasing, changing or modifying the CNC system, the accessories by itself.
- The user should be responsible for the danger because of the mistaken operation, regulation, maintenance, installation and storage.

# CONTENTS

## I Programming

CHAPTER 1 PROGRAMMING .....	1
1.1 GSK980TDc Introduction .....	1
1.1.1 Product introduction .....	1
1.1.2 Technical specification .....	2
1.1.3 Environment and conditions.....	4
1.1.4 Power supply.....	5
1.1.5 Guard .....	5
1.2 CNC System of Machine Tools and CNC Machine Tools .....	5
1.3 Programming Fundamentals.....	7
1.3.1 Coordinates definition .....	7
1.3.2 Machine coordinate system, Machine Zero and machine reference point.....	7
1.3.3 Workpiece coordinate system and Program Zero .....	8
1.3.4 Interpolation function.....	9
1.3.5 Absolute programming and incremental programming .....	10
1.3.6 Diameter programming and radius programming.....	10
1.4 Structure of an NC Program.....	11
1.4.1 General structure of a program.....	11
1.4.2 Main program and subprogram .....	15
1.5 Program Run .....	15
1.5.1 Sequence of program run .....	15
1.5.2 Execution sequence of word.....	16
1.6 Basic Axis Incremental System .....	17
1.6.1 Incremental system speed of basic axis .....	17
1.6.2 Incremental system unit of basic axis .....	17
1.6.3 Incremental system data range of basic axis.....	18
1.6.4 Incremental system data range and unit of basic axis.....	18
1.6.5 Program address value unit and range of incremental system of basic axis .....	20
1.7 Additional Axis Incremental System .....	21
1.7.1 Additional axis being the current incremental system .....	21
1.7.2 Additional axis being IS-A incremental system.....	21
CHAPTER 2 MSTF COMMAND.....	22
2.1 M (Miscellaneous Function) .....	22
End of program M02 .....	22
End of program run M30 .....	22
Subprogram call M98 .....	23
Return from subprogram M99.....	23
Macro program call M9000~M9999.....	24
M commands defined by standard PLC ladder diagram .....	24
Program stop M00.....	25
Program optional stop M01.....	25
Spindle CW, CCW and stop control M03, M04, M05 .....	26
Cooling control M08, M09 .....	26
Tailstock control M10, M11.....	26

Chuck control M12, M13 .....	26
Spindle position/speed control switch M14, M15 .....	26
Spindle clamped/released M20, M21 .....	27
The 2nd spindle position/speed switch M24, M25 .....	27
Lubricating control M32, M33 .....	27
Spindle automatic gear change M41, M42, M43, M44 .....	27
Spindle 8-point orientation M50~M58 .....	27
The 2nd spindle rotation CCW, rotation CW , stop M63, M64, M65 .....	27
<b>2.2 Spindle Function .....</b>	<b>28</b>
2.2.1 Spindle speed switching value control .....	28
2.2.2 Spindle speed analog voltage control .....	28
2.2.3 Constant surface speed control G96, constant rotational speed control G97 .....	29
2.2.4 Spindle override .....	31
2.2.5 Multiple spindle control function .....	32
2.2.6 Cs contour control funciton .....	33
<b>2.3 Tool Function .....</b>	<b>33</b>
2.3.1 Tool control .....	33
2.3.2 Tool life management .....	37
<b>CHAPTER 3 G COMMANDS .....</b>	<b>46</b>
<b>3.1 Commands .....</b>	<b>46</b>
3.1.1 Modal, non-modal and initial mode .....	47
3.1.2 Omitting words .....	48
3.1.3 Related definitions .....	49
3.2 Rapid Traverse Movement G00 .....	49
3.3 Linear Interpolation G01 .....	50
3.4 Circular Interpolation G02, G03 .....	51
3.5 Three-point Circular Interpolation G05 .....	54
3.6 Ellipse Interpolation G6.2, G6.3 .....	56
3.7 Parabola Interpolation G7.2, G7.3 .....	59
3.8 Plane Selection G17~G19 .....	61
3.9 Polar Coordinate Interpolation G12.1, G13.1 .....	62
3.10 Cylindrical Interpolation G7.1 .....	65
3.11 Chamfering Function .....	68
3.11.1 Linear chamfering .....	68
3.11.2 Circular chamfering .....	70
3.11.3 Special cases .....	72
3.12 Dwell G04 .....	74
3.13 Machine Zero Function .....	74
3.13.1 Machine 1st reference point G28 .....	74
3.13.2 Machine 2nd, 3rd, 4th reference point G30 .....	75
3.14 Skip Interpolation G31 .....	77
3.15 Automatic Tool Offset G36, G37 .....	79
3.16 Workpiece Coordinate System G50 .....	81
3.17 Local Coordinate System .....	82
3.18 Workpiece Coordinate System G54~G59 .....	84
3.19 Fixed Cycle Command .....	87
3.19.1 Axial cutting cycle G90 .....	87
3.19.2 Radial cutting cycle G94 .....	90



3.19.3	Caution of fixed cycle commands .....	92
3.20	Multiple Cycle Commands .....	93
3.20.1	Axial roughing cycle G71 .....	93
3.20.2	Radial roughing cycle G72 .....	99
3.20.3	Closed cutting cycle G73 .....	103
3.20.4	Finishing cycle G70 .....	107
3.20.5	Axial grooving multiple cycle G74 .....	108
3.20.6	Radial grooving multiple cycle G75 .....	111
3.21	Thread Cutting Commands .....	114
3.21.1	Thread cutting with constant lead G32 .....	115
3.21.2	Rigid thread cutting G32.1 .....	117
3.21.3	Thread cutting with variable lead G34 .....	119
3.21.4	Z thread cutting G33 .....	121
3.21.5	Rigid tapping G84, G88 .....	122
3.21.6	Thread cutting cycle G92 .....	125
3.21.7	Multiple thread cutting cycle G76 .....	128
3.22	Constant Surface Speed Control G96, Constant Rotational Speed Control G97 .....	132
3.23	Feedrate per Minute G98, Feedrate per Rev G99 .....	133
3.24	Additional Axis Function .....	135
3.24.1	Additional axis start .....	135
3.24.2	Motion of additional axis .....	135
3.24.3	Additional axis coordinates display .....	135
3.25	Macro Commands .....	135
3.25.1	MACRO variables .....	136
3.25.2	Operation and jump command G65 .....	140
3.25.3	Program example with macro command .....	143
3.26	Statement Macro Command .....	146
3.26.1	Arithmetic and logic operation .....	146
3.26.2	Transfer and cycle .....	147
3.27	Metric/Inch Switch .....	150
<b>CHAPTER 4</b>	<b>TOOL NOSE RADIUS COMPENSATION (G41, G42) .....</b>	<b>152</b>
4.1	Application .....	152
4.1.1	Overview .....	152
4.1.2	Imaginary tool nose direction .....	152
4.1.3	Compensation value setting .....	156
4.1.4	Command format .....	157
4.1.5	Compensation direction .....	157
4.1.6	Notes .....	159
4.1.7	Application .....	160
4.2	Tool Nose Radius Compensation Offset Path .....	161
4.2.1	Inner and outer side .....	161
4.2.2	Tool traversing when starting tool .....	162
4.2.3	Tool traversing in Offset mode .....	163
4.2.4	Tool traversing in Offset canceling mode .....	167
4.2.5	Tool interference check .....	168
4.2.6	Commands for canceling compensation vector temporarily .....	170

## II Operation

CHAPTER 1 OPERATION MODE AND DISPLAY INTERFACE.....	173
1.1 Panel Division.....	173
1.1.1 State indication.....	174
1.1.2 Edit keypad.....	174
1.1.3 Menu display.....	175
1.1.4 Machine panel.....	176
1.2 Summary of Operation Mode.....	179
1.3 Display Interface.....	179
1.3.1 POS interface.....	179
1.3.2 PRG interface.....	184
1.3.3 TOOL OFFSET Interface.....	189
1.3.4 ALARM interface.....	193
1.3.5 Setting interface.....	194
1.3.6 PARAMETER Interfaces.....	196
1.3.7 Diagnosis Interface.....	198
1.3.8 Graph Interface.....	199
1.3.9 Ladder Interface.....	200
CHAPTER 2 POWER ON/OFF AND PROTECTION.....	205
2.1 System Power-on.....	205
2.2 System Power-off.....	205
2.3 Overtravel Protection.....	206
2.3.1 Hardware overtravel protection.....	206
2.3.2 Software Overtravel Protection.....	206
2.4 Emergency Operation.....	207
2.4.1 Reset.....	207
2.4.2 Emergency stop.....	207
2.4.3 Feed hold.....	207
2.4.4 Power-off.....	207
CHAPTER 3 MANUAL OPERATION.....	209
3.1 Coordinate Axis Move.....	209
3.1.1 Manual feed.....	209
3.1.2 Manual rapid traverse.....	209
3.1.3 Speed tune.....	210
3.2 Other Manual Operations.....	211
3.2.1 Spindle CCW, CW, stop control.....	211
3.2.2 Spindle jog.....	211
3.2.3 Cooling control.....	212
3.2.4 Lubricating control.....	212
3.2.5 Chuck control.....	212
3.2.6 Tailstock control.....	213
3.2.7 Hydraulic control.....	213
3.2.8 Manual tool change.....	213
3.2.9 Spindle override.....	214
CHAPTER 4 MPG/STEP OPERATION.....	215
4.1 Step Feed.....	215

4.1.1	Increment selection .....	215
4.1.2	Moving direction selection.....	216
4.2	MPG(handwheel) Feed .....	216
4.2.1	Increment selection .....	217
4.2.2	Moving axis and direction selection .....	217
4.2.3	Other operations .....	218
4.2.4	Explanation items.....	219
CHAPTER 5	MDI OPERATION .....	220
5.1	Block Input.....	220
5.2	Block Execution .....	221
5.3	Parameter Setting.....	221
5.4	Data Alteration .....	222
5.5	Other Operations .....	222
CHAPTER 6	PROGRAM EDIT AND MANAGEMENT .....	223
6.1	Program Creation .....	223
6.1.1	Creating a block number .....	223
6.1.2	Inputting a program .....	223
6.1.3	Searching a character .....	226
6.1.4	Inserting a character .....	229
6.1.5	Deleting a character .....	230
6.1.6	Altering a character .....	230
6.1.7	Deleting a single block .....	231
6.1.8	Copying and pasting a block.....	232
6.1.9	Canceling and recovering a program.....	233
6.1.10	Program save .....	233
6.1.11	Macro program edit .....	234
6.1.12	Creating and modifying a program annotation .....	234
6.2	Deleting Programs.....	235
6.2.1	Deleting a program.....	235
6.2.2	Deleting all programs .....	237
6.3	Selecting a Program.....	238
6.3.1	Searching .....	238
6.3.2	Scanning .....	239
6.3.3	Direct confirmation .....	239
6.4	Executing a Program .....	240
6.5	Renaming a Program .....	241
6.6	Copying a Program .....	242
6.7	Program Management.....	244
6.7.1	Program list.....	244
6.8	Other Operations Available in Edit Mode .....	244
CHAPTER 7	TOOL OFFSET AND SETTING .....	246
7.1	Tool Positioning Setting .....	246
7.2	Trial Toolsetting.....	247
7.3	Toolsetting by Machine Zero Return .....	248
7.4	Coordinates Record .....	251
7.5	Setting and Altering the Offset Value .....	252
7.5.1	Offset setting .....	252

7.5.2	Offset alteration .....	252
7.5.3	Offset alteration in communication mode .....	253
7.5.4	Clearing the offset values .....	253
7.5.5	Setting and altering the tool wear .....	253
7.5.6	Locking and unlocking the offset value .....	254
7.5.7	No.0 tool offset moving workpiece coordinate system .....	254
<b>CHAPTER 8 AUTO OPERATION .....</b>		<b>256</b>
8.1	Automatic Run .....	256
8.1.1	Selection of a program running .....	256
8.1.2	Start of automatic run .....	256
8.1.3	Stop of automatic run .....	256
8.1.4	Automatic run from an arbitrary block .....	257
8.1.5	Adjustment of the feedrate, rapid rate .....	258
8.1.6	Spindle speed adjustment .....	258
8.2	Running State .....	259
8.2.1	Single block execution .....	259
8.2.2	Dry run .....	259
8.2.3	Machine lock .....	259
8.2.4	MST lock .....	260
8.2.5	Block skip .....	260
8.3	MPG Trial-cut .....	260
8.3.1	Switching MPG trial-cut mode .....	260
8.3.2	Command speed in MPG trial-cut mode .....	261
8.3.3	Notes in MPG trial-cut mode .....	262
8.3.4	Temporarily invalid in MPG trial-cut mode .....	262
8.4	Other Operations .....	263
<b>CHAPTER 9 ZERO RETURN OPERATION .....</b>		<b>264</b>
9.1	Program Zero Return .....	264
9.1.1	Program Zero .....	264
9.1.2	Program zero return steps .....	264
9.2	Machine Zero Return .....	265
9.2.1	Machine Zero .....	265
9.2.2	Machine Zero return steps .....	265
9.3	Other Operations in Zero Return .....	266
<b>CHAPTER 10 DATA SETTING .....</b>		<b>267</b>
10.1	Data Setting .....	267
10.1.1	Switch setting .....	267
10.1.2	Level setting .....	267
10.1.3	Parameter operation .....	270
10.2	Clock Setting .....	271
10.3	Graphic Display .....	272
10.4	Parameter Setting .....	275
10.4.1	State parameter .....	275
10.4.2	Data parameter, pitch compensation .....	278
10.4.3	Often used parameters .....	280
<b>CHAPTER 11 U OPERATION FUNCTION .....</b>		<b>283</b>
11.1	File Management Function Introduction .....	283

11.2	Often Used File Operation Function Introduction.....	283
11.2.1	File extension and return.....	283
11.2.2	File selection and cancellation of file selection .....	284
11.2.3	File copy .....	286
11.3	Data Copy and Resume .....	286
11.3.1	Entering backup/resume page .....	286
11.3.2	Backup/resume operation .....	287
11.3.3	Operation path selection .....	287
11.3.4	Format of data backup/resume file.....	288
11.3.5	Level explanation of data backup/resume operation .....	289
11.4	Notes.....	289
CHAPTER 12 COMMUNICATION .....		290
12.1	GSK980TDc Communication Software GSKComm .....	290
12.1.1	GSKComm's system (PC) requirements .....	290
12.1.2	Software interface .....	290
12.1.3	Receiving files (CNC→PC).....	291
12.1.4	Sending files (CNC→PC).....	293
12.1.5	Part program management.....	295
12.2	Preparatory before Communication .....	296
12.2.1	Communication cable connection.....	296
12.2.2	Communication setting baud rate .....	296
CHAPTER 13 MACHINING EXAMPLES .....		298
13.1	Programming .....	299
13.2	Program Input.....	301
13.2.1	View a saved program .....	301
13.2.2	Creating a new program .....	301
13.3	Checkout a Program .....	302
13.3.1	Graphic setting.....	302
13.3.2	Program check.....	302
13.4	Toolsetting and Running.....	303

### III Connection

CHAPTER 1 NSTALLATION LAYOUT .....		<b>307</b>
1.1	GK980TDc System Connection .....	307
1.1.1	GK980TDc, GSK980TDc-V rear cover interface layout .....	308
1.1.2	Interface explanation.....	308
1.2	GSK980TDc Installation .....	308
1.2.1	GSK980TDc external dimensions.....	308
1.2.2	Preconditions of the cabinet installation .....	308
1.2.3	Measures against interference .....	308
CHAPTER 2 DEFINITION & CONNECTION OF INTERFACE SIGNALS.....		<b>310</b>
2.1	Connection to Drive Unit .....	310
2.1.1	Drive interface definition .....	310
2.1.2	Code pulse and direction signals.....	310
2.1.3	Drive unit alarm signal nALM.....	310

2.1.4	Axis enable signal nEN .....	311
2.1.5	Pulse disable signal nSET .....	311
2.1.6	Zero signal nPC .....	311
2.1.7	Connection to a drive unit .....	313
2.2	Being Connected with Spindle Encoder .....	314
2.2.1	Spindle encoder interface definition .....	314
2.2.2	Signal explanation .....	314
2.2.3	Being connected with spindle encoder interface .....	314
2.3	Being Connected with MPG (Manual Pulse Generator) .....	315
2.3.1	MPG interface definition .....	315
2.3.2	Signal explanation .....	315
2.4	Spindle Interface .....	316
2.4.1	Spindle interface definition .....	316
2.4.2	Connection to inverter .....	317
2.5	GSK980Tdc / GSK980Tdc-V being Connected with PC .....	317
2.5.1	Communication interface definition .....	317
2.5.2	Communication interface connection .....	317
2.6	Power Interface Connection .....	318
2.7	I/O Interface Definition .....	318
2.7.1	Input signal .....	320
2.7.2	Output signal .....	321
2.8	I/O Function and Connection .....	323
2.8.1	Stroke limit and emergency stop .....	323
2.8.2	Tool change control .....	325
2.8.3	Machine zero return .....	331
2.8.4	Spindle control .....	337
2.8.5	Spindle switching volume control .....	340
2.8.6	Spindle automatic gearing control .....	341
2.8.7	Spindle eight-point orientation function .....	343
2.8.8	Spindle Cs axis control function .....	346
2.8.9	Multiple spindle function .....	349
2.8.10	Rigid tapping function .....	353
2.8.11	External cycle start and feed hold .....	354
2.8.12	Cooling control .....	355
2.8.13	Lubricating control .....	356
2.8.14	Chuck control .....	357
2.8.15	Tailstock control .....	360
2.8.16	Low pressure detection .....	361
2.8.17	Hydraulic control (only applied to 980Tdc-V) .....	362
2.8.18	Safety door detection .....	362
2.8.19	CNC macro variables .....	363
2.8.20	External override .....	363
2.8.21	External MPG .....	364
2.8.22	Tri-color Lamp .....	365
2.8.23	Gear/tool number display (only applied to 980Tdc-V) .....	365
2.9	Commonly Use Symbol of Electricity Drawing .....	366
<b>CHAPTER 3 PARAMETERS .....</b>		<b>367</b>
3.1	Parameter Description (by sequence) .....	367
3.1.1	Bit parameter .....	376

3.1.2	Data parameter .....	390
3.1.3	PLC parameters (standard PLC definition) .....	390
3.2	Parameter Description (by function sequence).....	394
3.2.1	X, Z, Y, 4 <sup>th</sup> ,5 <sup>th</sup> axis control logic.....	394
3.2.2	Acceleration & deceleration control .....	396
3.2.3	Precision compensation.....	397
3.2.4	Machine protection.....	399
3.2.5	Machine zero return .....	400
3.2.6	Threading function .....	403
3.2.7	Spindle control.....	404
3.2.8	Tool compensation .....	406
3.2.9	Tool life management function .....	406
3.2.10	Tool wear parameter .....	407
3.2.11	Edit and display .....	407
3.2.12	Communication setting .....	408
3.2.13	MPG Parameters .....	408
3.2.14	PLC axis control function .....	408
3.2.15	Skip function.....	409
3.2.16	Automatic tool setting function .....	409
3.2.17	Input and output function in metric and inch system .....	410
3.2.18	Parameters related to arc turning .....	410
3.2.19	Parameters related to the additional.....	410
<b>CHAPTER 4</b>	<b>MACHINE DEBUGGING METHODS AND MODES.....</b>	<b>412</b>
4.1	Emergency Stop and Limit .....	412
4.2	Drive Unit Configuration .....	412
4.3	Gear Ratio Adjustment .....	412
4.4	ACC&DEC Characteristic Adjustment.....	413
4.5	Mechanical (Machine) Zero Adjustment.....	414
4.6	Spindle Adjustment.....	416
4.6.1	Spindle encoder .....	416
4.6.2	Spindle brake .....	416
4.6.3	Switch volume control of spindle speed.....	417
4.6.4	Analog voltage control of spindle speed .....	418
4.7	Backlash Offset .....	417
4.8	Tool Post Debugging .....	418
4.9	Step/MPG Adjustment .....	418
<b>CHAPTER 5</b>	<b>DIAGNOSIS MESSAGE.....</b>	<b>420</b>
5.1	CNC Diagnosis.....	420
5.1.1	I/O status and data diagnosis message.....	420
5.1.2	CNC motion state and data diagnosis message .....	420
5.1.3	Diagnosis keys .....	421
5.1.4	Others.....	422
5.2	PLC State .....	422
5.2.1	X address (machine→PLC , defined by standard PLC ladders) .....	422
5.2.2	Y address (PLC→machine, defined by standard PLC ladders) .....	424
5.2.3	Machine panel.....	426
5.2.4	F address(CNC→PLC) .....	428
5.2.5	G address (PLC→CNC).....	432

5.2.6	Address A (message display requiry signal, defined by standard PLC ladders)...	437
5.2.7	K address (K parameter, standard PLC definition) .....	438
5.3	PLC Data .....	440
5.3.1	Timer address T(defined by standard PLC ladders).....	440
5.3.2	Counter address C(Defined by standard PLC Ladders).....	441
5.3.3	Timer presetting address DT(Defined by standard PLC ladders) .....	441
5.3.4	Counter presetting address DC .....	442
<b>CHAPTER 6 MEMORIZING PITCH ERROR COMPENSATION.....</b>		<b>443</b>
6.1	Function Description.....	443
6.2	Specification .....	443
6.3	Parameter Setting .....	443
6.3.1	Pitch compensation.....	443
6.3.2	Pitch error compensation number.....	443
6.3.3	Pitch error compensation interval .....	444
6.3.4	Offset value .....	444
6.4	Notes of Offset Setting .....	444
6.5	Setting Examples of Offset Parameters .....	444



---

# I Programming

---



## CHAPTER 1 PROGRAMMING

### 1.1 GSK980TDc Introduction

#### 1.1.1 Product introduction

GSK980TDc is a new upgraded software, its software, hardware based on GSK980TDb, its structure horizontal and vertical, matched with 8.4 inch color LCD, with 5 feed axes (including C axis), 2 analog spindles, least input increment 0.1 $\mu$ m. It uses the graphic interface, friendly human-machine operation window. It can realize the PLC on-line display, real-time monitoring and MPG trial-cut function.

Being upgraded product of GSK980TDb, GSK980TDc CNC turning is the better choice.



GSK980TDc

GSK980TDc-V

- X, Z, Y, 4<sup>th</sup>, 5<sup>th</sup>; axis name and axis type of Y, 4<sup>th</sup>, 5<sup>th</sup> can be defined
- 2ms interpolation period, control precision 1 $\mu$ m, 0.1 $\mu$ m
- Max. speed 60m/min (up to 24m/min in 0.1 $\mu$ m)
- Adapting to the servo spindle to realize the spindle continuously positioning, rigid tapping, and the rigid thread machining
- Built-in multi PLC programs, and the PLC program currently running can be selected
- G71 supporting flute contour cycle cutting
- Statement macro command programming, macro program call with parameter
- Metric/inch programming, automatic toolsetting, automatic chamfer, tool life management function
- Chinese, English, Spanish, Russian display can be selected by parameters.
- USB interface, U disc file operation, system configuration and software

- 2-channel 0V~10V analog voltage output, two-spindle control
- 1-channel MPG input, MPG function
- 41 input signals and 36 output signals
- Appearance installation dimension and command system are compatible with those of GSK980TDb, GSK980TDa

### 1.1.2 Technical specification

- Controllable axes
  - ◆ Controllable axes: 5 (X, Z, Y, 4<sup>th</sup>, 5<sup>th</sup>)
  - ◆ Link axes: 3
  - ◆ PLC controllable axes: 3 (X, Z, Y, 4<sup>th</sup>, 5<sup>th</sup>)
- Feed axis function
  - ◆ Least input increment: 0.001mm (0.0001inch) and 0.0001mm (0.00001inch)
  - ◆ Least command increment: 0.001mm (0.0001inch) and 0.0001mm (0.00001inch)
  - ◆ Position command range:  $\pm 99999999 \times$  least command unit
  - ◆ Rapid traverse speed: max. speed 60m/min in 0.001mm command unit, max. speed 24m/min in 0.0001mm command unit
  - ◆ Rapid override: F0, 25%, 50%, 100%
  - ◆ Feedrate override: 0~150% 16 grades to tune
  - ◆ Interpolation mode: linear interpolation, arc interpolation(three-point arc interpolation), thread interpolation, ellipse interpolation, parabola interpolation and rigid tapping
  - ◆ Automatic chamfer function
- Thread function
  - ◆ General thread(following spindle)/rigid thread
  - ◆ Single/multi metric, inch straight thread, taper thread, end face thread, constant pitch thread and variable pitch thread
  - ◆ Thread run-out length, angle, speed characteristics can be set
  - ◆ Thread pitch: 0.01mm~500mm or 0.06 tooth/inch~2540 tooth/inch
- Acceleration/deceleration function
  - ◆ Cutting feed: linear
  - ◆ Rapid traverse: linear, S
  - ◆ Thread cutting: linear, exponential
  - ◆ Initial speed, termination speed, time of acceleration/deceleration can be set by parameters
- Spindle function
  - ◆ 2-channel 0V~10V analog voltage output, two-spindle control
  - ◆ 1-channel spindle encoder feedback, spindle encoder line can be set (100p/r~5000p/r)
  - ◆ Transmission ratio between encoder and spindle: (1~255) : (1~255)
  - ◆ Spindle speed: it is set by S or PLC, and speed range: 0r/min~9999r/min
  - ◆ Spindle override: 50%~120% 8 grades tune
  - ◆ Spindle constant surface speed control
  - ◆ Rigid tapping
- Tool function

- ◆ Tool length compensation
- ◆ Tool nose radius compensation (C)
- ◆ Tool wear compensation
- ◆ Tool life management
- ◆ Toolsetting mode: fixed-point toolsetting, trial-cut toolsetting, reference point return toolsetting, automatic toolsetting
- ◆ Tool offset execution mode: modifying coordinate mode, tool traverse mode
- **Precision compensation**
  - ◆ Backlash compensation
  - ◆ Memory pitch error compensation
- **PLC function**
  - ◆ Two-level PLC program, up to 5000 steps, the 1<sup>st</sup> program refresh period 8ms
  - ◆ PLC program communication download
  - ◆ PLC warning and PLC alarm
  - ◆ Many PLC programs (up to 16PCS), the PLC program currently running can be selected
  - ◆ Basic I/O: 41 input signals /36 output signals
- **Man-machine interface**
  - ◆ 8.4" wide screen LCD, resolution: 640×480
  - ◆ Chinese, English, Spanish, Russian display
  - ◆ Planar tool path display
  - ◆ Real-time clock
- **Operation management**
  - ◆ Operation mode: edit, auto, MDI, machine zero return, MPG/single, manual, program zero return
  - ◆ Multi-level operation privilege management
  - ◆ Alarm record
- **Program edit**
  - ◆ Program capacity: 40MB, 384 programs (including subprograms and macro programs)
  - ◆ Edit function: program/block word search, modification, deletion
  - ◆ Program format: ISO command, statement macro command programming, relative coordinate, absolute coordinate and compound coordinate programming
  - ◆ Program call: macro program call with parameter, 4-level program built-in
- **Communication function**
  - ◆ RS232: two-way transmitting part programs and parameters, PLC program, system software serial upgrade
  - ◆ USB: U file operation, U file directly machining, PLC program, system software U upgrade
- **Safety function**
  - ◆ Emergency stop
  - ◆ Hardware travel limit
  - ◆ Software travel check
  - ◆ Data backup and recovery

**■ G command table**

Command	Function	Command	Function	Command	Function
G00	Rapid traverse (positioning)	G30	2 <sup>nd</sup> , 3 <sup>rd</sup> , 4 <sup>th</sup> reference point return	G71	Axial roughing cycle (flute cycle)
G01	Linear interpolation	G31	Skip function	G72	Radial roughing cycle
G02	CW arc interpolation	G32	Constant pitch thread cutting	G73	Closed cutting cycle
G03	CCW arc interpolation	G32.1	Rigid thread cutting	G70	Finishing cycle
G04	Dwell, exact stop	G33	Z tapping cycle	G74	Axial grooving cycle
G05	Three-point arc interpolation	G34	Thread cutting with variable lead	G75	Radial grooving cycle
G6.2	Ellipse interpolation (CW)	G36	Automatic tool compensation X	G76	Multiple thread cutting cycle
G6.3	Ellipse interpolation (CCW)	G37	Automatic tool compensation Z	G80	Rigid tapping state cancel
G7.2	Parabola interpolation (CW)	G40	Tool nose radius compensation cancel	G84	Axial rigid tapping
G7.3	Parabola interpolation (CCW)	G41	Tool nose radius compensation left	G88	Radial rigid tapping
G12.1	Polar coordinate interpolation	G42	Tool nose radius compensation right	G90	Axial cutting cycle
G7.1	Cylinder interpolation	G50	Workpiece coordinate system setting	G92	Thread cutting cycle
G15	Polar coordinate command cancel	G52	Local workpiece coordinate system	G94	Radial cutting cycle
G16	Polar coordinate command	G54	Workpiece coordinate system 1	G96	Constant surface speed control
G17	Plane selection command	G55	Workpiece coordinate system 2	G97	Constant surface speed control cancel
G18	Plane selection command	G56	Workpiece coordinate system 3	G98	Feed per minute
G19	Plane selection command	G57	Workpiece coordinate system 4	G99	Feed per revolution
G10	Data input ON	G58	Workpiece coordinate system 5		
G11	Data input OFF	G59	Workpiece coordinate system 6		
G20	Input in inch	G65	Macro command non-modal call		
G21	Input in metric	G66	Macro program modal call		
G28	Reference point return	G67	Macro program modal call cancel		

**1.1.3 Environment and conditions**

GSK980TDC storage delivery, working environment as follows:

Item	Working conditions	Storage delivery conditions
Ambient temperature	0℃~45℃	-40℃~+70℃
Ambient humidity	≤90%(no freezing)	≤95%(40℃)
Atmosphere pressure	86 kPa~106 kPa	86 kPa~106 kPa
Altitude	≤1000m	≤1000m

### 1.1.4 Power supply

GSK980TDc can normally run in the following AC input power supply.

Voltage: within  $(0.85 \sim 1.1) \times 200V$  (rated AC input voltage);

Frequency: 49Hz~51Hz continuously changing

### 1.1.5 Guard

GSK980TDc guard level is not less than IP20.

## 1.2 CNC System of Machine Tools and CNC Machine Tools

CNC machine tool is an electro-mechanical integrated product, composed of Numerical Control Systems of Machine Tools, machines, electric control components, hydraulic components, pneumatic components, lubricant, cooling and other subsystems (components), and CNC systems of machine tools are control cores of CNC machine tools. CNC systems of machine tools are made up of computerized numerical control(CNC), servo (stepper) motor drive devices, servo (or stepper) motor etc.

Operational principles of CNC machine tools: according to requirements of machining technology, edit user programs and input them to CNC, then CNC outputs motion control commands to the servo (stepper) motor drive devices, and last the servo (or stepper) motor completes the cutting feed of machine tool by mechanical driving device; logic control commands in user programs to control spindle start/stop, tool selections, cooling ON/OFF, lubricant ON/OFF are output to electric control systems of machine tools from CNC, and then the electric control systems control output components including buttons, switches, indicators, relays, contactors and so on. Presently, the electric control systems are employed with Programmable Logic Controller (PLC) with characteristics of compact, convenience and high reliance. Thereof, the motion control systems and logic control systems are the main of CNC machine tools.

GSK980TDc Turning Machine CNC system has simultaneously motion control and logic control function to control two axes of CNC machine tool to move, and has nested PLC function. Edit PLC programs (ladder diagram) according to requirements of input and output control of machine tool and then download them to GSK980TDc Turning Machine CNC system, which realizes the required electric control requirements of machine tool, is convenient to electric design of machine tool and reduces cost of CNC machine tool.

Software used to control GSK980TDc Turning Machine CNC system is divided into system software (NC for short) and PLC software (PLC for short). NC system is used to control the display, communication, edit, decoding, interpolation and acceleration/deceleration, and PLC system for controlling explanations, executions, inputs and outputs of ladder diagrams.

Standard PLC programs are loaded (except for the special order) when GSK980TDc Turning Machine CNC System is delivered, concerned PLC control functions in following functions and operations are described according to control logics of standard PLC programs, marking with "Standard PLC functions" in GSK980TDc Turning CNC System User Manual. Refer to Operation Manual of machine manufacturer about functions and operations of PLC control because the machine manufacturer may modify or edit PLC programs again.

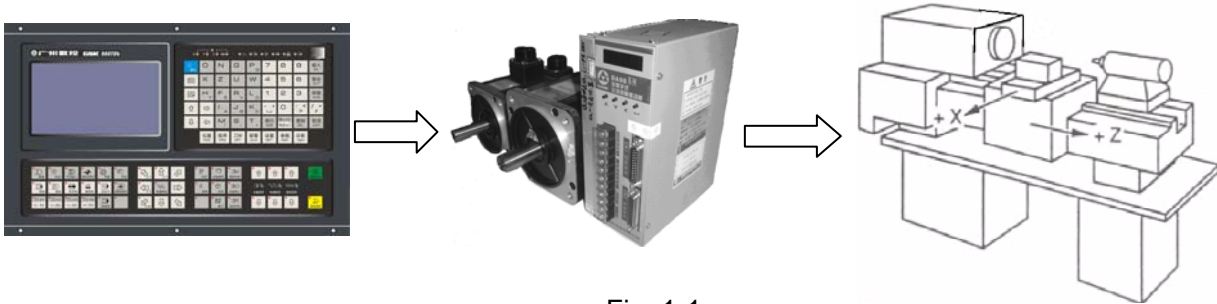

Fig. 1-1

Programming is a course of workpiece contours, machining technologies, technology parameters and tool parameters being edit into part programs according to special CNC programming G codes. CNC machining is a course of CNC controlling a machine tool to complete machining of workpiece according requirements of part programs.

Technical flow of CNC machining is as following Fig. 1-2.

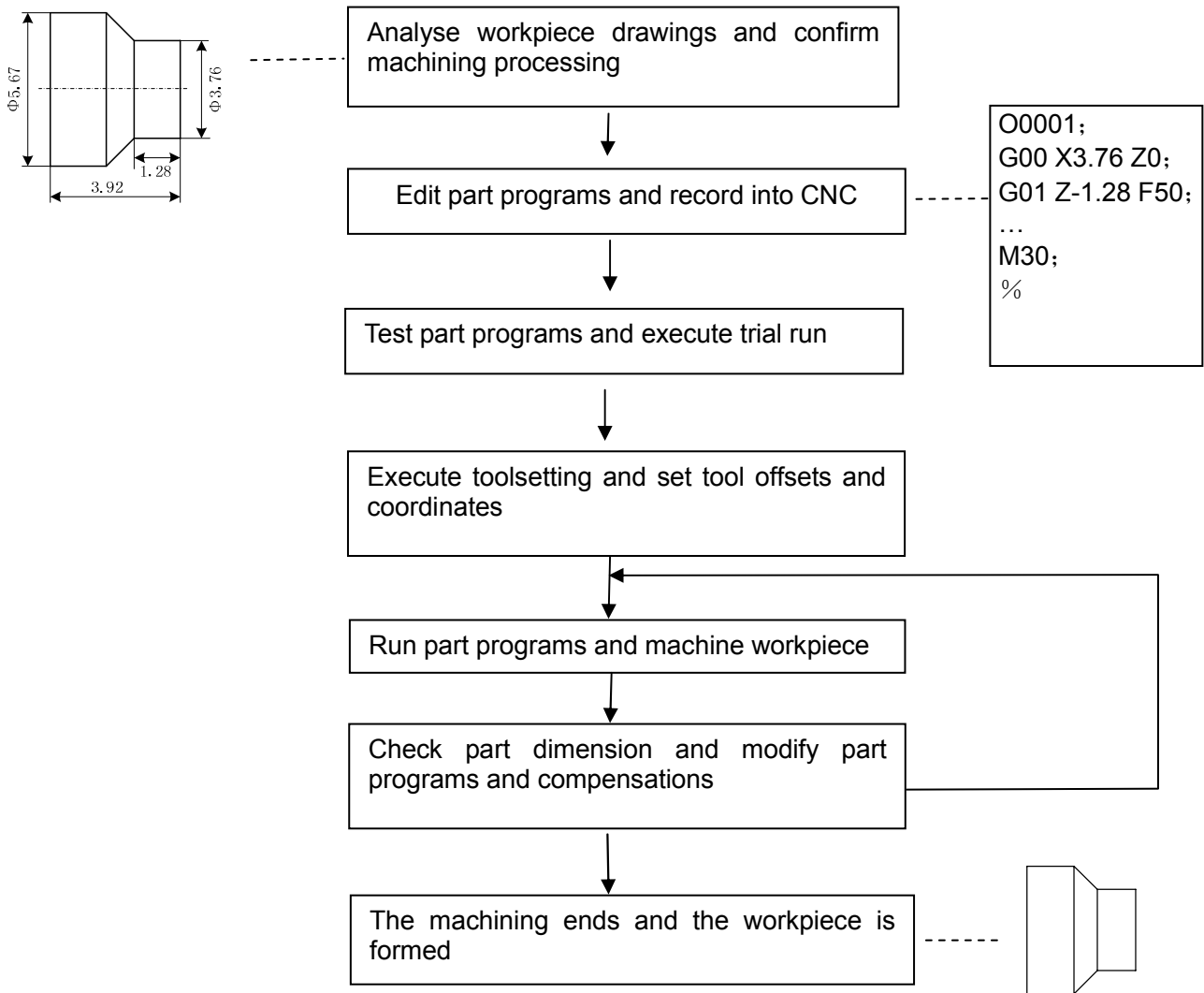

Fig. 1-2



## 1.3 Programming Fundamentals

### 1.3.1 Coordinates definition

Sketch map of CNC turning machine is as follows:

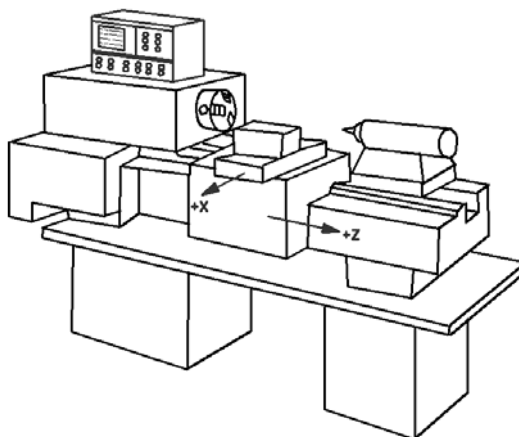

Fig. 1-3

GSK980TDC uses a rectangular coordinate system composed of X, Z axis. X axis is perpendicular with axes of spindle and Z axis is parallel with axes of spindle; negative directions of them approach to the workpiece and positive ones are away from it.

There is a front tool post and a rear tool post of NC turning machine according to their relative position between the tool post and the spindle, Fig. 1-4 is a coordinate system of the front tool post and Fig. 1-5 is a rear tool post one. It shows exactly the opposite of X axes, but the same of Z axes from figures. In the manual, it will introduce programming application with the front tool post coordinate system in the following figures and examples.

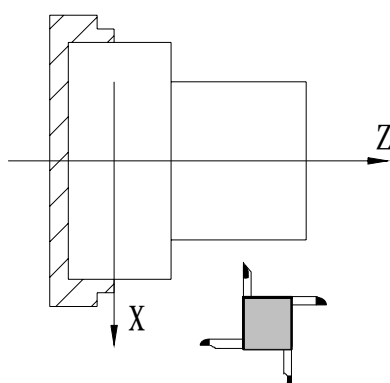

Fig.1-4 Front tool post coordinate system

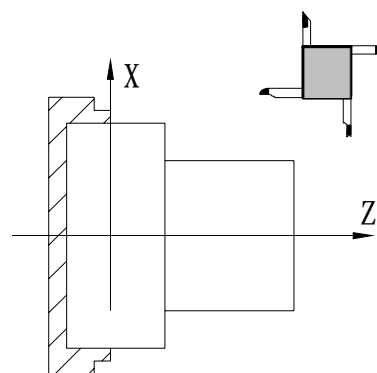

Fig.1-5 Rear tool post coordinate system

### 1.3.2 Machine coordinate system, Machine Zero and machine reference point

**Machine tool coordinate system** is a benchmark one used for CNC counting coordinates and a fixed one on the machine tool. **Machine tool zero** is a fixed point which position is specified by zero switch or zero return switch on the machine tool. Usually, the zero return switch is installed on max. stroke in X, Z positive direction. Machine reference point is located at the position at which the machine zero value adding the data parameter No.114/No.115 value. When No.114/No.115 value is 0, the machine reference point coincides with the machine zero. The coordinates of machine reference

point is the No.120/No.121 value. Machine zero return/G28 zero return is to execute the machine reference point return. After the machine zero return/machine reference point return is completed, GSK980TDC machine coordinate system which takes No.120 value as the reference point, which is referred to I Programming, Section 3.13.

**Note:** Do not execute the machine reference point return without the reference point switch installed on the machine tool, otherwise, the motion exceeds the travel limit and the machine to be damaged.

### 1.3.3 Workpiece coordinate system and Program Zero

The workpiece coordinate system is a rectangular coordinate system based on the part drawing, also called floating coordinate system. After the workpiece is installed on the machine, the absolute coordinates of tool's current position is set by G50 according to the workpiece's measure, and so the workpiece coordinate system is established in CNC. Generally, Z axis of the workpiece coordinate system coincides with the spindle axis. The established workpiece is valid till it is replaced by a new one. The system can set 6 workpiece coordinate systems G54~G59 in advance. Refer to I Programming, Section 3.18 about the details of workpiece coordinate system.

A sub workpiece coordinate system is created in a workpiece coordinate system, which is called as a local coordinate system. Refer to I Programming, Section 3.17 about the details of the local coordinate system.

The current position of workpiece coordinate system set by G50 is the program zero.

**Note:** Do not execute the machine reference point return without using G50 to set the workpiece coordinate system after power on, otherwise, the alarm occurs.

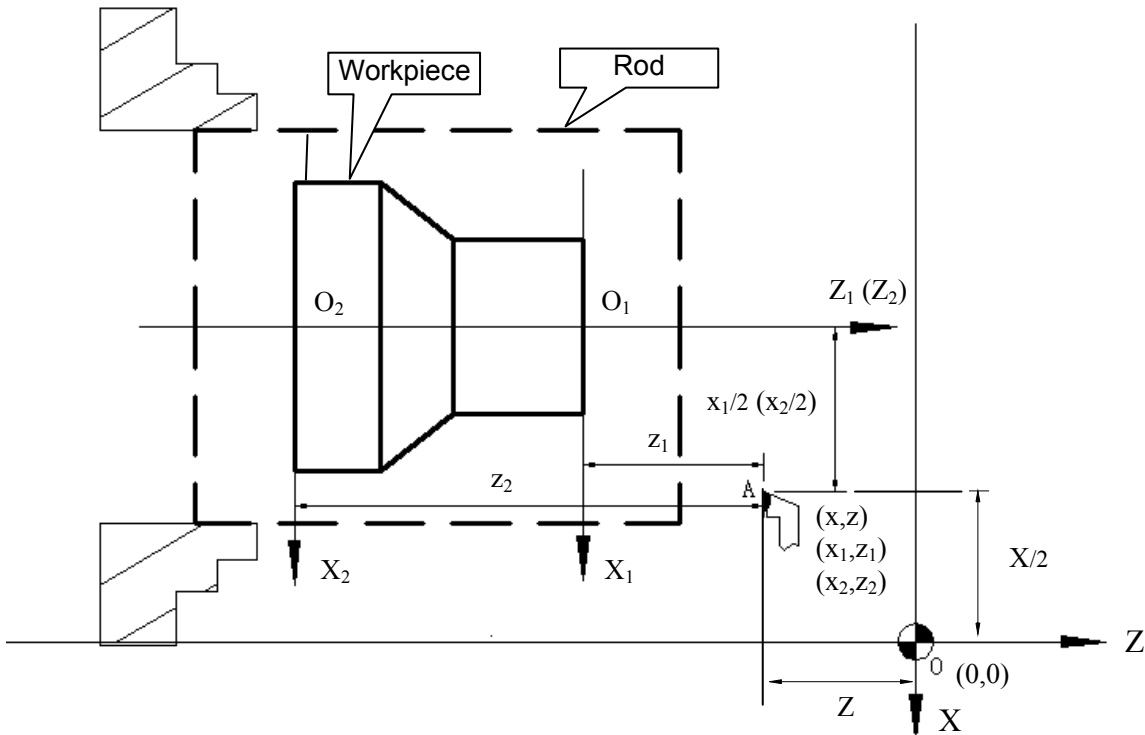

Fig. 1-6

In the above figure, XOZ is the coordinate system of machine tool,  $X_1O_1Z_1$  is the workpiece coordinate system of X axis located at the heading of workpiece,  $X_2O_2Z_2$  is the one of X axis located at the ending of workpiece, O point is the machine reference point, A point is the tool nose and

coordinates of A point in the above-mentioned coordinate systems is as follows:

A point in the machine tool coordinate system:  $(x,z)$ ;

A point in  $X_1O_1Z_1$  coordinate system:  $(x_1,z_1)$ ;

A point in  $X_2O_2Z_2$  coordinate system:  $(x_2,z_2)$ .

### 1.3.4 Interpolation function

**Interpolation** is defined as a planar or three dimensional contour formed by path of 2 or multiple axes moving at the same time, also called **Contour control**. The controlled moving axis is called link axis when the interpolation is executed. The moving distance, direction and speed of it are controlled synchronously in the course of running to form the required Composite motion path. Positioning control is defined that motion end point of one axis or multiple axes instead of the motion path in the course of running is controlled.

GSK980TDc X and Z axis are link axes and 2 axes link CNC system. The system possesses linear, circular and thread interpolation function.

Linear interpolation: Composite motion path of X, Z axis is a straight line from starting point to end point.

Circular interpolation: Composite motion path of X, Z axis is arc radius defined by R or the circle center (I, K) from starting point to end point.

Thread interpolation: Moving distance of X or Z axis or X and Z axis is defined by rotation angle of spindle to form spiral cutting path on the workpiece surface to realize the thread cutting. For thread interpolation, the feed axis rotates along with the spindle, the long axis moves one pitch when the spindle rotates one rev, and the short axis and the long axis directly interpolate.

Example:

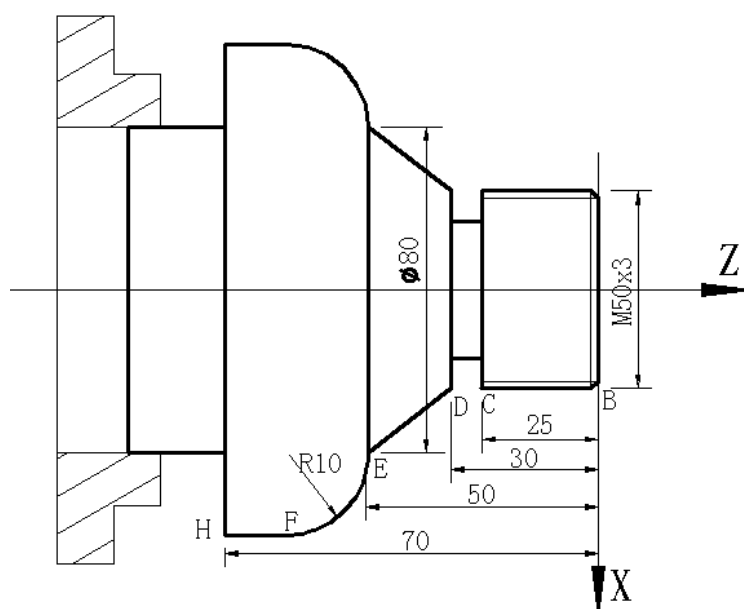

Fig. 1-7

...  
 G32 W-27 F3; (B→C; thread interpolation)  
 G1 X50 Z-30 F100;  
 G1 X80 Z-50; (D→E; linear interpolation)  
 G3 X100 W-10 R10; (E→F; circular interpolation)

...  
M30;

### 1.3.5 Absolute programming and incremental programming

Specify coordinate values of path's end point or target position in programming and there are 3 kinds of programming method according to coordinate values in programming: absolute programming, incremental programming and compound programming.

Programming with X/Z axis absolute coordinate value to program (present with X, Z) is defined to be the absolute programming;

Programming with X/Z axis incremental movement (present with U, W) is defined to be the incremental programming;

In the system, X, Z axis separately uses the absolute programming and incremental program, which is called the compound programming.

Example: A→B linear interpolation

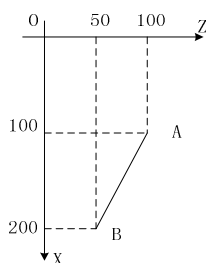

Fig.1-8

Absolute programming: G01 X200 Z50;

Incremental programming: G01 U100 W-50;

Compound programming: G01 X200 W-50; or G01 U100 Z50

**Note:** When there are command address X/ U or Z/ W at the same time, X/Z command value is valid.

Example: G50 X10 Z20;

G01 X20 W30 U20 Z30; 【End point of the block (X20, Z30)】

### 1.3.6 Diameter programming and radius programming

Programming methods of X coordinate values are divided into: diameter programming and radius programming.

Diameter programming: when NO.001 Bit2 is 0, X input command value is in diameter and X coordinate is in diameter at the moment;

Radius programming: when NO.001 Bit2 is 1, X input command value is in radius and X coordinate is in radius at the moment.

Addresses relevant to diameter or radius programming

	Address	Explanation	Diameter programming	Radius programming
Addresses relevant to diameter or radius	X	X coordinate	In diameter	In radius
		G50 setting X coordinate		
	U	X increment	In diameter	In radius
		X finishing allowance in G71, G72, G73	In diameter	In radius

	Address	Explanation	Diameter programming	Radius programming
programming		Moving distance of tool retraction when cutting to the end point in G74	In diameter	In radius

Except for addresses and data in Table 1-1, others (arc radius, taper in G90) are unrelated to diameter or radius programming, and their input values in X direction are defined by the radius.

**Note:** The diameter programming is used except for the special description in the following explanation.

## 1.4 Structure of an NC Program

User needs to compile part programs (called program) according to command formats of CNC system. CNC system executes programs to control the machine tool movement, the spindle starting/stopping, the cooling and the lubricant ON/OFF to complete the machine of workpiece.

Program example:

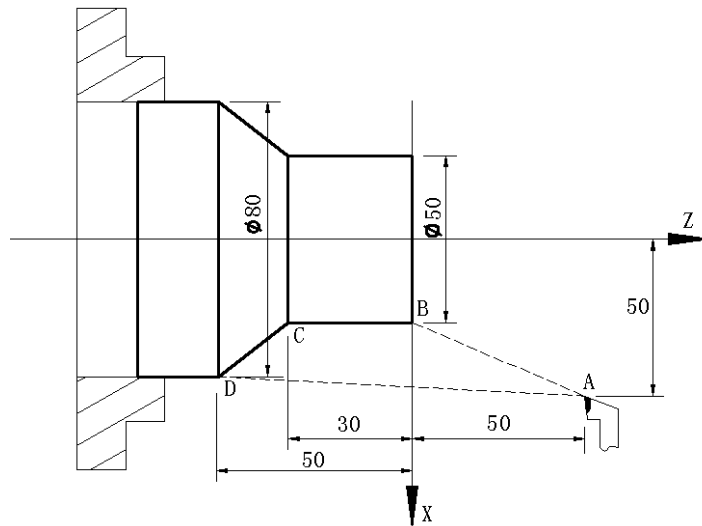

Fig. 1-9

The tool leaves the path of A→B→C→D→A after the above-mentioned programs are executed.

### 1.4.1 General structure of a program

**A program** consists of blocks. A block begins with a block number (it can be omitted) and several words ending with “;”. General structure of a program is shown in Fig.1-10:

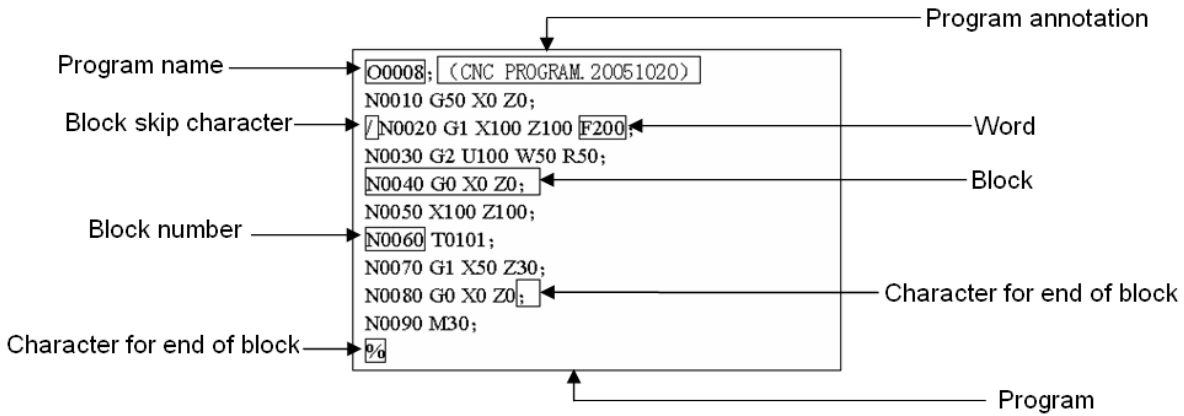
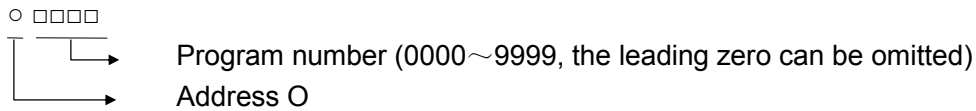

Fig. 1-10 Structure of a program

**Program name**

There are most 384 programs stored in GSK980TDc. To identify it, each program has only one program name (there is no the same program name) beginning with command address O and the following 4 digits.



**Word**

A word is the basic command unit to command CNC system to complete the control function, composed of an English letter (called command address) and the following number (operation command with/without sign). The command address describes the meaning of its following operation command and there may be different meaning in the same command address when the different words are combined together. All words of GSK980TDc are in Table 1-2.

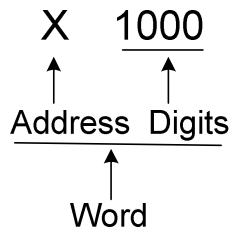

Table 1-2 Word table

Address	Command value range	Function meaning	Unit
O	0~9999	Program name	
N	0~9999	Block number	
G	00~99	Preparatory function	
X	-99999999~99999999	X coordinate	Relevant to IS-B, IS-C
	0~99999.999(s)	Pause time	
Z	-99999999~99999999	Z coordinate	Relevant to IS-B, IS-C
Y	-99999999~99999999	Y coordinate	Relevant to IS-B, IS-C
U	-99999999~99999999	X increment	Relevant to IS-B, IS-C
	0~99999.999(s)	Pause time	
	-99999~99999	X finishing allowance in G71,G72, G73	Relevant to IS-B, IS-C

Address	Command value range	Function meaning	Unit
	1~99999	Cutting depth in G71	Relevant to IS-B, IS-C
	-99999999~99999999	X tool retraction clearance in G73	Relevant to IS-B, IS-C
W	-99999999~99999999	Z increment	Relevant to IS-B, IS-C
	1~99999	Cutting depth in G72	Relevant to IS-B, IS-C
	-99999~99999	Z finishing allowance in G71,G72, G73	Relevant to IS-B, IS-C
	-99999999~99999999	Z tool retraction in G73	Relevant to IS-B, IS-C
V	-99999999~99999999	Y increment	Relevant to IS-B, IS-C
R	-99999999~99999999	Arc radius	Relevant to IS-B, IS-C
	1~99999	Tool retraction in G71, G72	Relevant to IS-B, IS-C
	1~9999 (times)	Roughing cycle times in G73	
	1~99999	Tool retraction clearance in G74, G75	Relevant to IS-B, IS-C
	1~99999	Tool retraction clearance from end point in G74, G75	Relevant to IS-B, IS-C
	1~99999999	Finishing allowance in G76	Relevant to IS-B, IS-C
	-99999999~99999999	Taper in G90, G92, G94, G96	Relevant to IS-B, IS-C
I	-99999999~99999999	X vector between arc center and starting point	Relevant to IS-B, IS-C
	0.06~25400 (tooth/inch)	Metric thread teeth	
K	-99999999~99999999	Z vector between arc center and starting point	Relevant to IS-B, IS-C
F	0~8000 (mm/min)	Feedrate per minute	
	0.0001~500(mm/r)	Feedrate per rev	
	0.001~500 (mm)	Metric thread lead	
S	0~9999 (r/min)	Spindle speed specified	
	00~04	Multi-gear spindle output	
T	01~32	Tool function	
M	00~99	Miscellaneous function output, program execution flow	
	9000~9999	Subprogram call	
P	0~99999999 (0.001s)	Pause time	
	0~9999	Calling times of subprogram number	
	0~999	Subprogram call times	
	0~99999999	X circle movement in G74, G75	Relevant to IS-B, IS-C
		Thread cutting parameter in G76	
	0~99999	Initial block number of finishing in the compound cycle command	
	1~99999999	Parabola mouth size in G7.2, G7.3	Relevant to IS-B, IS-C

Address	Command value range	Function meaning	Unit
Q	0~9999	End block number of finishing in the compound cycle	
	0~9999999	Z circle movement in G74, G75	Relevant to IS-B, IS-C
	1~9999999	First cut-in depth in G76	Relevant to IS-B, IS-C
	1~9999999	Min. cut-in depth in G76	Relevant to IS-B, IS-C
	0~360000	Offset angle between one-turn signal and starting point of thread cutting at the initial angle in G32	
	0~9999	Angle between long axis of the ellipse and Z in G6.2, G6.3	
	0~9999	Angle between long axis of the ellipse and Z in G7.2, G7.3	
A	0~99999999	Length of long radius of ellipse in G6.2, G6.3	Relevant to IS-B, IS-C
B	0~99999999	Length of short radius of ellipse in G6.2, G6.3	Relevant to IS-B, IS-C
H	01~99	Operand in G65	

**Block**

A block which is basic unit of CNC program consists of a sequence of words, ending with “;” or “\*”. There is the character “;” or “\*” between blocks. “;” is used to separate blocks in the manual as follows:

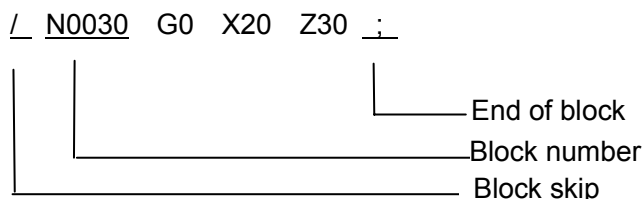

One block may be with a number of words or only with “;” ending character(EOB) instead of words. There must be one or more blank space between many words.

There is only one for other addresses except for N, G, S, T, H, L in one block, otherwise the system alarms. The last word in the same address is valid when there are more N, G, S, T, H, L in the same block. The last G code is valid when there are more G codes which are in the same group in one block.

**Block number**

A block number consists of an address N and its following 4-digit: N0000~N9999, and the leading zero can be omitted. The block number must be at the beginning of block, otherwise the block is invalid.

The block number can be omitted, but there must be the block number when the program calls/skips the target block. The increment of block number is at will and it better to increase or decrease the sequence of block number in order to conveniently search and analyze programs.

When “Automatic number” in the switch window is set to “ON”, block numbers will be automatically created incrementally and their increment is defined by No.42.



## Character for block skip

Insert “/” in the front of block and startup  when some block cannot be executed (cannot be deleted), and the system skips the block and executes the next one. The block with “/” in the front of it is executed if the block skip switch is not started.

## Character for end of a program

“%” is an ending character of program. “%” is a mark of communication ended when the program is transmitted. The system will automatically insert “%” at the end of program.

## Program annotation

A program annotation has less than 20 characters (10 Chinese characters) for each program, lies in a bracket following its program name and is expressed only in English and digitals in CNC system; it can be edited in Chinese in PC and displayed in Chinese in CNC system after being downloaded.

### 1.4.2 Main program and subprogram

To simply the programming, when the same or similar machining path and control procedure is used many times, its program commands are edited to a sole program to call. A program which calls the program is the main program and the called program (end with M99) is subprogram. They both take up the program capacity and storage space of system. The subprogram has own name, and can be called at will by the main program and also can run separately. The system returns to the main program to continue when the subprogram ends as follows.

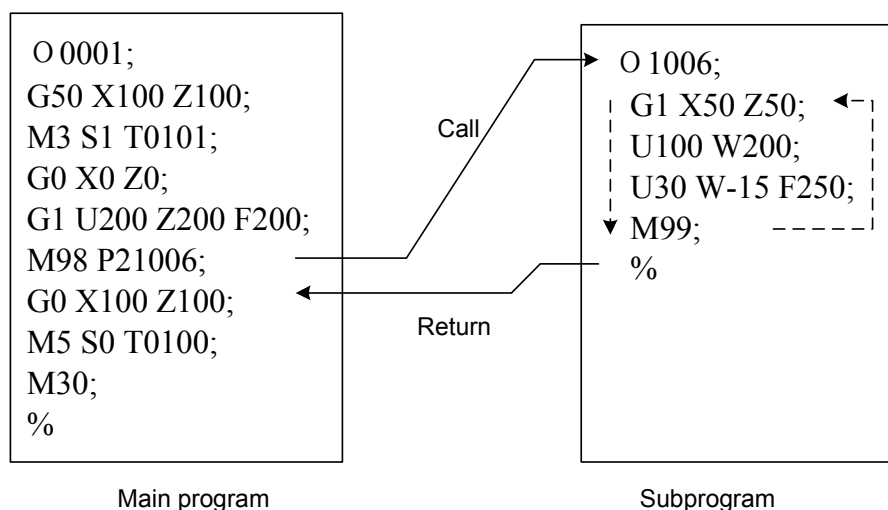







## 1.5 Program Run

### 1.5.1 Sequence of program run

Running the current open program must be in Auto mode. GSK980TDC cannot open two or more programs at the same, and runs only program any time. When the first block is open, the cursor is located in the heading of the first block and can be moved in Edit mode. In the run stop state in Auto

mode, the program starts to run by the cycle start signal ( is pressed or external cycle start signal) from a block pointed by current cursor, usually blocks are executed one by one according to their programming sequence, the program stops running till executing M02 or M30. The cursor moves along with program running and is located at the heading of the current block. Sequence and state of program running are changed in the followings:

- The program stops running after pressing  or emergent stop button;
- The program stops running when the system or PLC alarms;
- The program runs and single block stops (the program run stops after the current block runs completely) in Edit, MDI mode, and then a block pointed by the current cursor starts running after the system switches into Auto mode,  is pressed or external cycle start signal is switched on;
- The program stops running in Manual(Jog), Handwheel (MPG), Single Block, Program Reference Point Return, Machine Reference Point Return mode and it continuously runs from current position after the system is switched into Auto mode and  is pressed or the external cycle start signal is switched on;
- The program pauses after pressing  or the external cycle start signal is switched off, and it continuously runs from current position after pressing  or the external cycle start signal is switched on;
- When Single Block is ON, the program pauses after every block is executed completely, and then it continuously runs from the next block after  is pressed or the external cycle start signal is switched on;
- Block with “/” in the front of it is not executed when the block skipping switch is ON;
- The system skips to the target block to run after executing G65;
- Please see I Programming, Section Three G Commands about execution sequence of G70~73;
- Call corresponding subprograms or macro program to run when executing M98 or M9000~M9999; the system returns to main program to call the next block when executing M99(if M99 specifies a target block number, the system returns to it to run) after the subprograms or macro programs run completely;
- The system return to the first block to run and the current program is executed repetitively when M99 is executed in a main program.

### 1.5.2 Execution sequence of word

There are many words (G, X, Z, F, R, M, S, T and so on) and most of M, S, T is transmitted to PLC by NC explaining and others are directly executed by NC. M98, M99, M9000~M9999, S word used to specify the spindle speed r/min, m/min is directly executed by NC.

NC firstly executes G and then M commands when G codes and M00, M01, M02 and M30 are in the same block.

NC firstly executes G and then M commands( without transmitting M signal to PLC) when G



		0.001 (deg)	0.001 (deg)
Inch machine	metric input (G21)	0.001 (mm)	0.0001 (inch)
		0.001 (deg)	0.001 (deg)
	inch input (G20)	0.0001 (inch)	0.0001 (inch)
		0.001 (deg)	0.001 (deg)

0.1μ level (IS-C)		Least input increment (input)	Least command increment (output)
Metric machine	metric input (G21)	0.0001 (mm)	0.0001 (mm)
		0.0001 (deg)	0.0001 (deg)
	inch input (G20)	0.00001 (inch)	0.0001 (mm)
		0.0001 (deg)	0.0001 (deg)
Inch machine	metric input (G21)	0.0001 (mm)	0.00001 (inch)
		0.0001 (deg)	0.0001 (deg)
	inch input (G20)	0.00001 (inch)	0.00001 (inch)
		0.0001 (deg)	0.0001 (deg)

Least input increment (input) using the metric or the inch is specified by G20 or G21 or is completed by modifying #001 increment bit.

Least command increment(output) using the metric or the inch is determined by the machine, and is set by#004 output increment.

### 1.6.3 Incremental system data range of basic axis

In different incremental system and pulse output frequency, the corresponding different data range is as follows:

Incremental system		Command data input range	Data format
μ level (IS-B)	metric input (G21)	-99999.999 ~ 99999.999 (mm)	5.3
		-99999.999 ~ 99999.999 (deg)	5.3
	inch input (G20)	-9999.9999 ~ 9999.9999 (inch)	4.4
		-9999.999 ~ 9999.999 (deg)	4.3
0.1μ level (IS-C)	metric input (G21)	-9999.9999 ~ 9999.9999 (mm)	4.4
		-9999.9999 ~ 9999.9999 (deg)	4.4
	inch input (G20)	-999.99999 ~ 999.99999 (inch)	3.5
		-999.9999 ~ 999.9999 (deg)	3.4

Note : 5.3 in the above table means 5-bit integer and 3-bit decimal. And other data likes these.

### 1.6.4 Incremental system data range and unit of basic axis

- **Speed parameter**

Linear axis speed parameter unit is determined by the machine type. i.e.: metric machine speed unit: mm/min, inch machine is: 0.1inch/min.

Linear axis speed parameter range is determined by the machine type and incremental system type.

Data parameter No. 027(cutting upper speed):

Machine type	Incremental system	Linear axis speed unit	Parameter range	Rotary axis speed unit
Metric machine	$\mu$ level (IS-B)	mm/min	10~ 15000	deg/min
	0.1 $\mu$ level (IS-C)		10~ 15000	
Inch machine	$\mu$ level (IS-B)	0.1inch/min	5~58000	
	0.1 $\mu$ level (IS-C)		5~5800	

Rotary axis does not execute the metric/inch conversion, the rotary axis speed unit is deg/min; the parameter range is the same that of metric machine.

The different incremental system switch may cause the set max. run speed in the data parameter exceeding max. range permitted by the system, so, the operator should modify the speed parameter to avoid the unexpected when the first power-on after switch.

### ● Incremental parameter

The unit and range of linear axis incremental parameter are determined by the machine type and incremental system type as follows:

Machine type	Incremental system	Linear axis incremental unit	Linear axis parameter range
Metric machine	$\mu$ level (IS-B)	0.001mm	-99,999.999~ 99,999.999
	0.1 $\mu$ level (IS-C)	0.0001 mm	-9,999.9999~ 9,999.9999
Inch machine	$\mu$ level (IS-B)	0.0001inch	-9,999.9999~ 9,999.9999
	0.1 $\mu$ level (IS-C)	0.00001 inch	-999.99999~ 999.99999

The rotary axis does not execute the metric/inch switch, the unit of rotary axis incremental parameter is determined by the incremental system type. The range of rotary axis incremental parameter is the same that of the metric machine.

Machine type	Incremental system	Rotary axis speed unit	Rotary axis parameter range
Metric, Inch machine	$\mu$ level (IS-B)	0.001°	0~ 99999.999
	0.1 $\mu$ level (IS-C)	0.0001°	0~ 9999.9999

### ● Programming value input range

Linear axis coordinate data unit is determined by the metric/inch input system. i.e. metric input is mm; inch input is inch;

Linear axis coordinate data range is determined by metric/inch input system and incremental system. The range is the same that of the command data input range as follows:

Incremental system		Linear axis coordinate data range
$\mu$ level (IS-B)	Metric input (G21)	-99999.999 ~ 99999.999(mm)
	Inch input (G20)	-9999.9999 ~ 9999.9999(inch)
0.1 $\mu$ level (IS-C)	Metric input (G21)	-9999.9999 ~ 9999.9999(mm)
	Inch input (G20)	-999.99999 ~ 999.99999(inch)

The rotary axis does not execute the metric/inch switch, the rotary axis coordinate data unit is deg. The range of programmed value is shown below:

Input type	Incremental system	Rotary axis coordinate data range
Metric, inch input	$\mu$ level (IS-B)	-99999.999 ~ 99999.999 (deg)
	0.1 $\mu$ level (IS-C)	-9999.9999 ~ 9999.9999(deg)

### ● Offset data

Offset data unit is determined by metric/inch input system. i.e. metric input is mm; inch input is inch.

Offset data range is limited to 9999999 and is determined by the metric/inch input system and incremental system as follows:

Input type	Incremental system	Offset data unit	Offset data range
Metric input(G21)	μ level (IS-B)	mm	±9999.999
	0.1μ level (IS-C)		±999.9999
Inch input (G20)	μ level (IS-B)	inch	±999.9999
	0.1μ level (IS-C)		±99.99999

● **Pitch data compensation**

Linear axis pitch compensation unit and range are determined by the machine type and incremental system type as follows:

Machine type	Incremental system	Linear axis data unit	Linear axis pitch compensation data range
Metric machine	μ level (IS-B)	0.001mm	-2550~2550
	0.1μ level (IS-C)	0.0001mm	-2550~2550
Inch machine	μ level (IS-B)	0.0001inch	-2550~2550
	0.1μ level (IS-C)	0.00001inch	-2550~2550

The rotary axis does not execute the metric/inch switch, the rotary axis pitch compensation unit is determined by the least input unit as follows.

Machine type	Incremental system	Rotary axis pitch compensation unit	Rotary axis pitch compensation range
Metric, inch machine	μ level (IS-B)	0.001°	0~255
	0.1μ level (IS-C)	0.0001°	0~2550

**1.6.5 Program address value unit and range of incremental system of basic axis**

● **Pitch definition and range:**

	Command	μ level (IS-B)	0.1μ level (IS-C)	Unit
Metric input (G21)	F	0.001~500.000	0.0001~500.00	mm/tooth[lead]
	I	0.06~25400	0.06~2540	tooth[lead]/inch
Inch input (G20)	F	0.0001~50.00	0.00001~50.0	inch/tooth[lead]
	I	0.06~2540	0.06~254	tooth[lead]/inch

● **Speed F definition**

G98 m/min: feed per minute: F unit: mm/min

G99 feed per rev: F definition and range are as follows:

Incremental system	Address	Metric input	Inch input
IS-B system	F (G98)	0~99999.999 (mm/min)	0~99999.999 (mm/min)
IS-C system		0~9999.9999 (mm/min)	0~9999.9999 (mm/min)
IS-B system	F (G99)	0~500 (mm/r)	0~500 (mm/r)
IS-C system		0~50 (mm/r)	0~50 (mm/r)

## 1.7 Additional Axis Incremental System

Least incremental system in  $\mu$  level (IS-B) or  $0.1\mu$  level (IS-C), the additional axis does not execute the link, and is not used alone. When the least incremental output of additional axis is 0.01 in the low precision requirement and the feedrate must be fast, and so the working efficiency largely increases. The least incremental system of additional axis does not sometime consist with the current least incremental system. The system adds the optional function of the least incremental system of the additional axis (Y, 4<sup>th</sup>, 5<sup>th</sup> axis).

Additional axis incremental system is set by No..187 as follows:

<b>187</b>	<b>nIS1</b>	<b>nIS0</b>							
------------	-------------	-------------	--	--	--	--	--	--	--

nIS1, nIS0: select the least incremental system of each additional axis (n means the axis name of each additional axis)

nIS1	nIS0	Incremental system of axis	Least input/output
0	0	Same with current incremental system of basic axis (XY)	
0	1	IS-A	0.01
1	0	IS-B	0.001
1	1	IS-C	0.0001

**Note:** The least I/O in the above table is expressed without considering the metric/inch and rotary axis.

### 1.7.1 Additional axis being the current incremental system

IS-B or IS-C: the relative speed and data range of additional axis is the same that the described in Section 1.6.

### 1.7.2 Additional axis being IS-A incremental system

IS-A: the max. speed of additional axis is separate 10 times and 100 times of IS-B and IS-C. The relative data and parameter range are same those of the incremental system of current basic axis (refer to Section 1.6).

## CHAPTER 2 MSTF COMMAND

### 2.1 M (Miscellaneous Function)

M command consists of command address M and its following 1~2 or 4 bit digits, used for controlling the flow of executed program or outputting M commands to PLC.

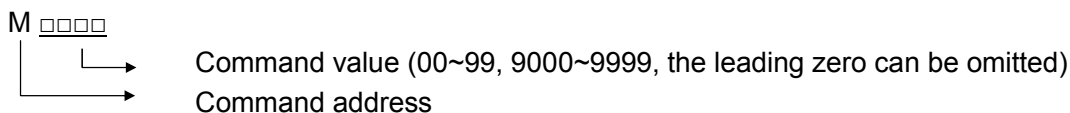

M98, M99, M9000~M9999 is executed by NC separately and NC does not output M commands to PLC.

M02, M03 are for ending of programs defined by NC, and NC outputs M commands to PLC which can control spindle OFF, cooling OFF and so on.

M98, M99, M9000~M9999 are for calling programs, M02, M30 are for ending of program which are not changed by PLC. Other M commands output to PLC and their function are defined by PLC. Please refer to User Manual from machine manufacturer.

There is only one M command in one block, otherwise the system alarms.

Table 2-1 M commands to control program execution

Commands	Functions
M02	End of program
M30	End of program
M98	Call subprograms
M99	Return from a subprogram; it is executed repeatedly when the program ends in M99(the current program is not called by other programs)
M9000~M9999	Call macro programs(their program numbers are more than 9000)

#### End of program M02

Command format: M02 or M2

Command function: In Auto mode, after other commands of current block are executed, the automatic run stops, and the cursor stops a block in M02 and does not return to the start of program. The cursor must return to the start of program when the program is executed again.

Besides the above-mentioned function executed by NC, M02 function is also defined by PLC ladder diagram as follows: current output of CNC is reserved after M02 is executed.

#### End of program run M30

Command format: M30

Command function: In Auto mode, after other commands of current block are executed in M30, the automatic run stops, the amount of workpiece is added 1, the tool nose radius compensation is cancelled and the cursor returns to the start of program (whether the cursor return to the start of program or not is defined by parameters).

If No.005 Bit 4 is set to 0, the cursor does not return to the beginning of program, and the cursor returns immediately after the program is executed completely when No.005 Bit 4 is set to 1.

Except for the above-mentioned function executed by NC, M30 function is also defined by PLC



ladder diagram as follows: the system closes M03, M04 or M08 signal output and outputs M05 signal after M30 is executed.

**Subprogram call M98**

Command format:

M98 P○○○○□□□□

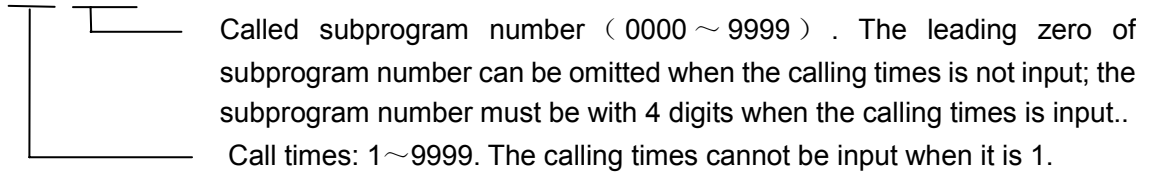

Command function: In Auto mode, after other commands are executed in M98, CNC calls subprograms specified by P, and subprograms are executed 9999 times at most. M98 is invalid in MDI mode.

**Return from subprogram M99**

Command format: M99 P○○○○

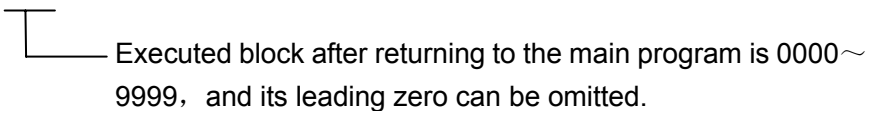

Command function: After other commands of current block in the subprogram are executed, the system returns to the main program and continues to execute next block specified by P, and calls a block following M98 of current subprogram when P is not input. The current program is executed repeatedly when M99 is defined to end of program (namely, the current program is executed without calling other programs). M99 is invalid in MDI mode.

Example: Execution path of calling subprogram (with P in M99) as Fig. 2-1.  
Execution path of calling subprogram (without P in M99) as Fig. 2-2.

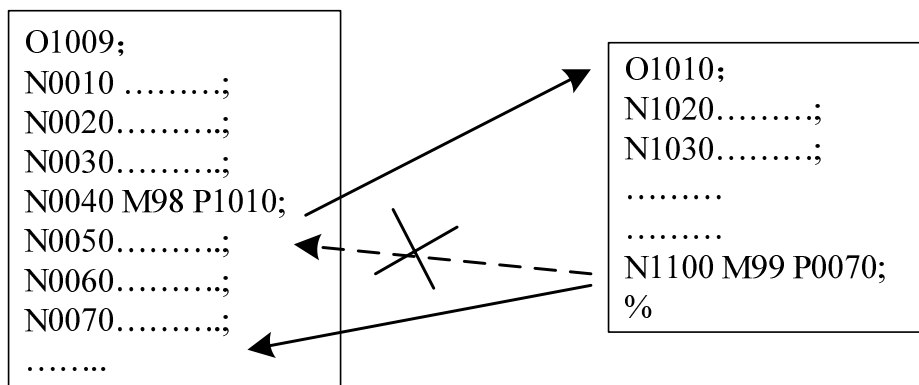

Fig. 2-1

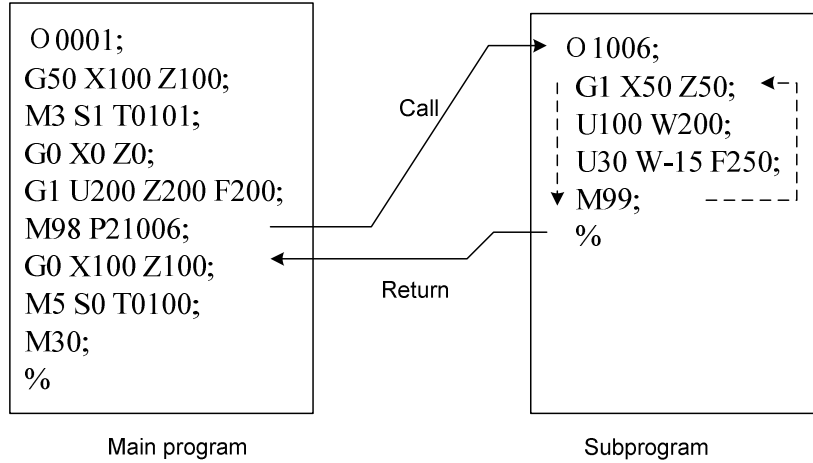

Fig. 2-2

Subprogram calls can be nested up to four levels as shown in Fig. 2-3.

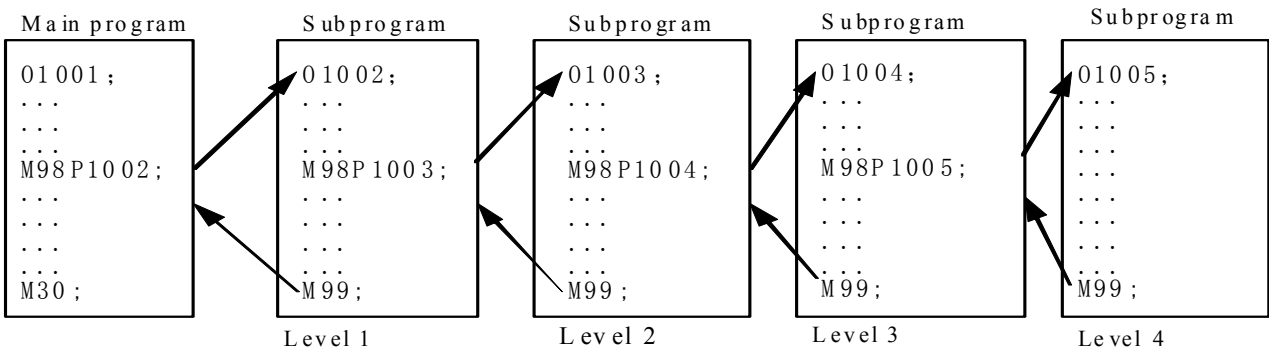

Fig. 2-3 Subprogram nesting

**Macro program call M9000~M9999**

Command format:  $M\text{□□□□}$   
└──────────┘ 9000~9999

Command function: call macro programs corresponding to command values (O9000~O9999).

Macro programs: O9000~O9999 programs are for machine manufacturer, used for editing subprogram with special functions, called macro programs. The system must have 2-level operation level (machine manufacturer) when editing O9000~O9999, and macro programs calling commands are executed to call with 3~5 operation level. M9000~M9999 are invalid in MDI mode.

**M commands defined by standard PLC ladder diagram**

Other M commands are defined by PLC except for the above-mentioned ones(M02, M30, M98, M99, M9000~M9999). The following M commands are defined by standard PLC, and GSK980TDC Turning Machine CNC system is used for controlling machine tool. Refer to commands of machine manufacturer about functions, significations, control time sequence and logic of M commands.

M commands defined by standard PLC ladder diagram.

Table 2-2 M commands

Command	Function	Remark
M00	Program pause	
M01	Program optional stop	
M03	Spindle clockwise (CW)	Functions interlocked and states reserved
M04	Spindle counterclockwise (CCW)	
*M05	Spindle stop	
M08	Cooling ON	Functions interlocked and states reserved
*M09	Cooling OFF	
M10	Tailstock forward	Functions interlocked and states reserved
M11	Tailstock backward	
M12	Chuck clamping	Functions interlocked and states reserved
M13	Chuck releasing	
M14	Spindle position control	Functions interlocked and states reserved
*M15	Spindle speed control	
M20	Spindle clamping	Functions interlocked and states reserved
*M21	Spindle releasing	
M24	The 2 <sup>nd</sup> spindle position control	Functions interlocked and states reserved
*M25	The 2 <sup>nd</sup> spindle speed control	
M32	Lubricating ON	Functions interlocked and states reserved
*M33	Lubricating OFF	
*M50	Spindle orientation cancel	Functions interlocked and states reserved
M51	Spindle orientate to No. 1 point	
M52	Spindle orientate to No. 2 point	
M53	Spindle orientate to No. 3 point	
M54	Spindle orientate to No. 4 point	
M55	Spindle orientate to No. 5 point	
M56	Spindle orientate to No. 6 point	
M57	Spindle orientate to No. 7 point	
M58	Spindle orientate to No. 8 point	
M63	The 2nd spindle rotation CCW	Functions interlocked and states reserved
M64	The 2nd spindle rotation CW	
*M65	The 2nd spindle stop	
*M41, M42, M43, M44	Spindle automatic gear shifting	Functions interlocked and states reserved

Note: Commands with "\*" defined by standard PLC is valid when power on.

### Program stop M00

Command format: M00 or M0

Command function: After M00 is executed, the program stops and the system displays "Pause", and then the program continuously runs after the cycle start key is pressed.

### Program optional stop M01

Command format: M01 or M1



Command function: in AUTO, MDI mode, it is valid. Press  and its indicator lights and the system enters the optional stop state, at the moment, the program stops run and the system displays “PAUSE” after M01 is executed, after the cycle start key is pressed, the program continuously runs. When the program optional stop switch is not open, the program does not pause even if M01 runs.

### Spindle CW, CCW and stop control M03, M04, M05

Command format: M03 or M3  
M04 or M4;  
M05 or M5.

Command function: M03: Spindle CW rotation;  
M04: Spindle CCW rotation;  
M05: Spindle stop.

**Note:** Refer to time sequence of output defined by standard PLC ladder in III INSTALLATION & CONNECTION.

### Cooling control M08, M09

Command format: M08 or M8;  
M09 or M9;  
Command function: M08: Cooling ON;  
M09: Cooling OFF.

**Note:** Refer to time sequence and logic of M08, M09 defined by standard PLC ladder in III INSTALLATION & CONNECTION.

### Tailstock control M10, M11

Command format: M10;  
M11;  
Command function: M10: tailstock going forward;  
M11: tailstock going backward.

**Note:** Refer to time sequence and logic of M10, M11 defined by standard PLC ladder in III INSTALLATION & CONNECTION

### Chuck control M12, M13

Command format: M12;  
M13;  
Command function: M12: chuck clamping;  
M13: chuck releasing.

**Note:** Refer to time sequence and logic of M12, M13 defined by standard PLC ladder in III INSTALLATION & CONNECTION.

### Spindle position/speed control switch M14, M15

Command format: M14;  
M15;  
Command function: M14: spindle is in the position control mode from speed control mode;  
M15: spindle is in speed control mode from the position control mode.

**Note:** Refer to time sequence and logic of M14, M15 defined by standard PLC ladder in III INSTALLATION

**& CONNECTION.****Spindle clamped/released M20, M21**

Command format: M20;  
M21;

Command function: M20: spindle clamped  
M21: spindle released

**Note:** Refer to time sequence and logic of M20, M21 defined by standard PLC ladder in III INSTALLATION & CONNECTION.

**The 2nd spindle position/speed switch M24, M25**

Command format: M24;  
M25;

Command function: M24: The 2<sup>nd</sup> spindle is switched from the speed control mode to the position control mode;  
M25: The 2<sup>nd</sup> spindle is switched from the position control mode to the speed control mode.

**Note:** Refer to time sequence and logic of M24, M25 defined by standard PLC ladder in III INSTALLATION & CONNECTION.

**Lubricating control M32, M33**

Command format: M32;  
M33;

Command function: M32: lubricating ON;  
M33: lubricating OFF.

**Note:** Refer to time sequence and logic of M32, M33 defined by standard PLC ladder in III INSTALLATION & CONNECTION.

**Spindle automatic gear change M41, M42, M43, M44**

Command format: M4n; (n=1, 2, 3, 4)

Command function: When the system executes M4n, the spindle changes to gear n.

**Note:** Refer to time sequence and logic of M41, M42, M43, M44 defined by standard PLC ladder in III INSTALLATION&CONNECTION.

**Spindle 8-point orientation M50~M58**

Command format: M5n; (n=0~8)

Command function: M50: cancel orientation state;  
M5n(n=0~8): the spindle oriented to No. n point.

**Note:** Refer to time sequence and logic of M50~M58 defined by standard PLC ladder in III INSTALLATION & CONNECTION.

**The 2nd spindle rotation CCW, rotation CW , stop M63, M64, M65**

Command format: M63;  
M64;

M65;

Command function:

M63: spindle rotation CCW;

M64: spindle rotation CW;

M65: spindle stop.

**Note 1:** The sequence of M63, M64, M65 defined by the standard PLC is the same that of M03, M04, M05.

**Note 2:** The function is enabled when the 2nd spindle function is valid.

## 2.2 Spindle Function

S command is used for controlling spindle speed and this GSK980TDc has two modes to control it:

Spindle speed switching value control: S□□(2 digits command value)is executed by PLC, and PLC outputs switching value signal to machine tool to change spindle speed with grades.

Spindle speed analog voltage control: S□□□□(4 digits command value)specifies actual speed of spindle and NC outputs 0~10V analog voltage signal to spindle servo or converter to realize stepless spindle speed.

### 2.2.1 Spindle speed switching value control

Spindle speed is controlled by switching value when No.001 BIT4 is set to 0. There is only one S command in a block, otherwise the system alarms.

Their executing sequence is defined by PLC when S command and word for moving function are in the same block. Please refer to *User Manual* from machine manufacturer.

When spindle speed is controlled by switching value, GSK980TDc Turning CNC system is used for machine tool and the time sequence and logic of executing S command is according to *User Manual* from machine manufacturer. Refer to S command defined by standard PLC of GSK980TDc as follows:

Command format: S□□

└── 00~04(the leading zero can be omitted): No.1~No.4 gear of spindle speed is controlled by switching value.

In spindle speed switching value control mode, after S signal transmits to PLC, the system dwells time defined by No.081, then return FIN signal, and the dwell time is called runtime of S command.

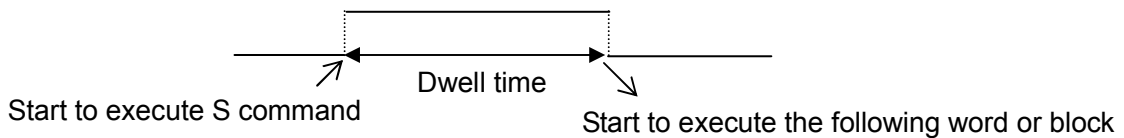

S01, S02, S03, S04 output are reserved when resetting CNC.

S1~S4 output are invalid when CNC is switched on. The corresponding S signal output is valid and reserved, and others are cancelled at the same time when executing one of S01, S02, S03, S04. When executing S00, S1~S4 output are cancelled and only one of S1~S4 is valid at the same time.

### 2.2.2 Spindle speed analog voltage control

Spindle speed is controlled by analog voltage when No.001 BIT4 is set to 1.

Command format: S □□□□

└── 0000~9999 (the leading zero can be omitted.):Spindle speed

## analog voltage control

Command function: The spindle speed is defined, and the system outputs 0~10V analog voltage to control spindle servo or converter to realize the stepless timing. S command value is not reserved, and it is 0 after the system is switched on.

When the spindle speed analog voltage control is valid, there are 2 methods to input the spindle speed: the spindle fixed speed is defined by S command( r/min), and is invariant without changing S command value, which is called constant speed control(G97 modal); other is the tangent speed of tool relative to the outer circle of workpiece defined by S command, which is called constant surface speed control (G96 modal), and the spindle speed is changed along with the absolute coordinates value of X absolute coordinates in programming path when cutting feed is executed in the constant surface speed.

Please refer to Section 2.2.3.

The system can execute 4 gears spindle speed. Count the analog voltage value corresponding to the specified speed according to setting value(corresponding to No.037~No.040) of max. spindle speed (analog voltage is 10V)of current gear, and then output to spindle servo or converter to ensure that the spindle actual speed and the requirement are the same.

After the system is switched on, the analog output voltage is 0V. The analog output voltage is reserved (except that the system is in cutting feed in the surface speed control mode and the absolute value of X absolute coordinates is changed) after S command is executed. The analog output voltage is 0V after S0 is executed. The analog output voltage is reserved when the system resets and emergently stops.

Parameters relative to the analog voltage control of spindle speed:

System parameter No.021: offset value of output voltage with max. spindle speed (the analog output voltage is 10V);

System parameter No.036: offset value of output voltage with spindle speed 0 (the analog output voltage is 10V);

System parameter No.037~No.040: max. spindle speed (the analog output voltage is 10V) with spindle 1~4 gears(corresponding to M41~M44).

### 2.2.3 Constant surface speed control G96, constant rotational speed control G97

Command format: G96 S\_\_; (S0000~S9999, the leading zero can be omitted.)

Command function: The constant surface speed control is valid, the cutting surface speed is defined (m/min) and the constant rotational speed control is cancelled. G96 is modal G code. If the current modal is G96, G96 cannot be input.

Command format: G97 S\_\_; (S0000~S9999, the leading zero can be omitted.)

Command function: The constant surface speed control is cancelled, the constant rotational speed control is valid and the spindle speed is defined (r/min). G96 is modal G code. If the current modal is G97, G97 cannot be input.

Command format: G50 S\_\_; (S0000~S9999, the leading zero can be omitted.)

Command function: define max. spindle speed limit (r/min) in the constant surface speed control and take the current position as the program reference point.

G96, G97 are the modal word in the same group but one of them is valid. G97 is the initial word and the system defaults G97 is valid when the system is switched on.

When the machine tool is turning it, the workpiece rotates based on the axes of spindle as the center line, the cutting point of tool cutting workpiece is a circle motion around the axes, and the instantaneous speed in the circle tangent direction is called **cutting surface** (for short **surface**

speed). There are different surface speed for the different workpiece and tool with different material. When the spindle speed controlled by the analog voltage is valid, the constant surface control is valid. The spindle speed is changed along with the absolute value of X absolute coordinates of programming path in the constant speed control. If the absolute value of X absolute coordinates adds, the spindle speed reduces, and vice versa, which make the cutting surface speed as S command value. The constant speed control to cut the workpiece makes sure all smooth finish on the surface of workpiece with diameter changing.

$$\text{Surface speed} = \text{spindle speed} \times |X| \times \pi \div 1000 \quad (\text{m/min})$$

Spindle speed: r/min

|X|: absolute value of X absolute coordinate value, mm

$\pi \approx 3.14$

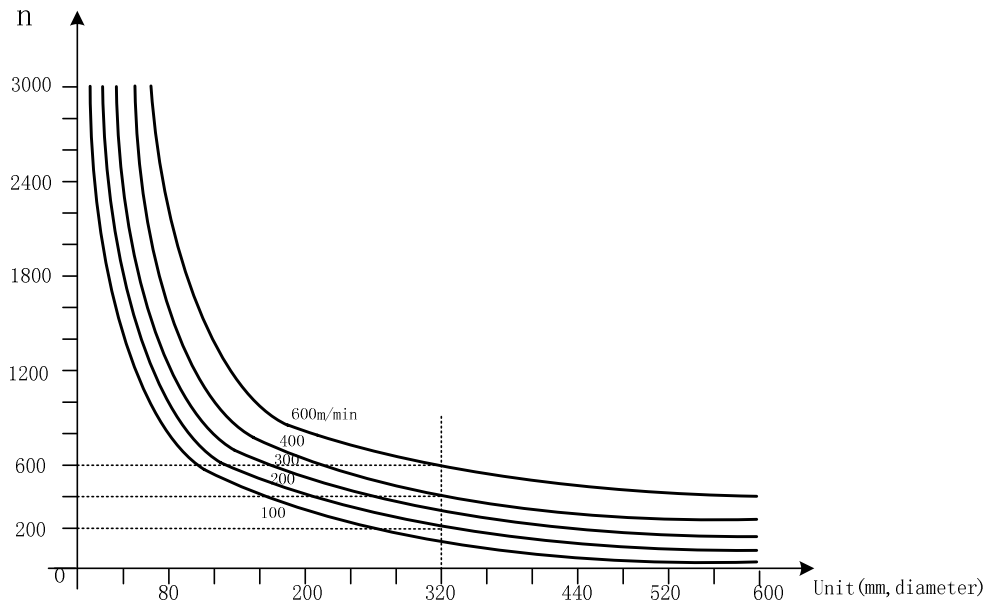

Fig. 2-4

In G96, the spindle speed is changed along with the absolute value of X absolute coordinates value of programming path in cutting feed (interpolation), but it is not changed in G00 because there is no actual cutting and is counted based on the surface speed of end point in the program block.

In G96 (constant surface speed control), Z coordinates axis of workpiece system must consist with the axes of spindle (rotary axis of workpiece), otherwise, there is different between the actual surface speed and the defined one.

G96 control is valid, G50 S\_ can limit max. spindle speed (r/min). The spindle actual speed is the limit value of max. speed when the spindle speed counted by the surface speed and X coordinates value is more than the max. spindle speed set by G50 S\_. After the system powers on, max. spindle speed limit value is not defined and its function is invalid. Max. spindle speed limit value defined by G50 S\_ is reserved before it is defined again and its function is valid in G96. Max. spindle speed defined by G50 S\_ is invalid in G97 but its limit value is reserved.

**Note:** When NO.043 (lowest spindle speed in constant surface speed control) is set to 0 and G50 S0 is executed, the spindle speed is limited to 0 r/min (the spindle does not rotate).

When the constant surface speed is controlled by the system parameter No.043, the spindle speed is lower limit, which is higher than one counted by the surface speed and X axis coordinates



value.

Example:

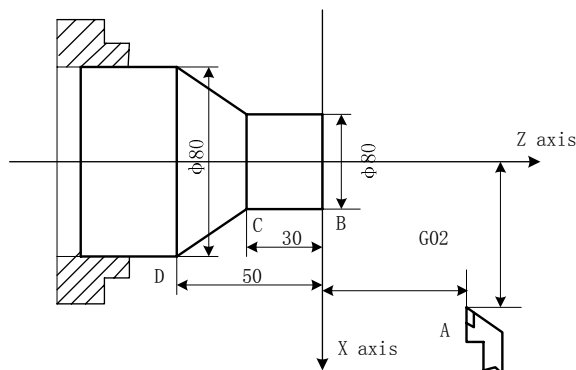

Fig. 2-5

```

O0001 ; (Program name)
N0010 M3 G96 S300; (Spindle rotates clockwise, the constant surface speed control is
valid and the surface speed is 300 m/min)
N0020 G0 X100 Z100; (Rapid traverse to A point with spindle speed 955 r/min)
N0030 G0 X50 Z0; (Rapid traverse to B point with spindle speed 1910 r/min)
N0040 G1 W-30 F200; (Cut from B to C with spindle speed 1910 r/min)
N0050 X80 W-20 F150; (Cut from C to D with spindle speed 1910 r/min and surface speed
1194 r/min)
N0060 G0 X100 Z100; (Rapid retract to A point with spindle speed 955 r/min)
N0110 M30; (End of program, spindle stopping and cooling OFF)
N0120 %

```

**Note 1:** S value commanded in G96 is also reserved in G97. Its value is resumed when the system is in G96 again; Example:

```

G96 S50; (Cutting surface speed 50m/min)
G97 S1000; (Spindle speed 1000 r/min)
G96 X3000; (Cutting surface speed 50m/min)

```

**Note 2:** The constant surface speed control is valid when the machine tool is locked (X, Z do not move when their motion command are executed);

**Note 3:** To gain the precise thread machining, it should not be adopted with the constant surface speed control but the constant rotational speed (G97) in the course of thread cutting;

**Note 4:** From G96 to G97, if none of S command (r/min) is commanded in the program block in G97, the last spindle speed in G96 is taken as S command in G97, namely, the spindle speed is not changed at this time;

**Note 5:** In G96, when the spindle speed counted by the cutting surface speed is more than max. speed of current spindle gear (system parameter No.037~No.040), at this time, the spindle speed is limited to max. one of current spindle gear.

## 2.2.4 Spindle override

When the spindle speed analog voltage control is valid, the spindle actual speed can be tuned real time by the spindle override and is limited by max spindle speed of current gear after the spindle override is tuned, and it also limited by limited values of max. and min. spindle speed in constant surface speed control mode.

The system supplies 8 steps for spindle override (50%~120% increment of 10%). The actual

steps and tune of spindle override are defined by PLC ladder and introductions from machine manufacturer should be referred when using it. Refer to the following functions of GSK980TDC standard PLC ladder.

The spindle actual speed specified by GSK980TDC standard PLC ladder can be tuned real time by the spindle override tune key at 8 steps in 50%~120% and it is not reserved when the spindle override is switched off. Refer to the operations of spindle override in II OPERATION.

### 2.2.5 Multiple spindle control function

GSK980TDC can control up to two analog spindles. One S code is used to command one of them which are selected by PLC signal and which have the gear change function.

Because GSK980TDC has only one spindle encoder interface, the 2<sup>nd</sup> spindle has no encoder feedback and the spindle speed is not displayed.

Being the speed command, S code is sent to the spindle selected by the spindle selection signal (SWS1, SWS2 <G27#0, G27#1>), and each spindle rotates with the specified speed. When the spindle has not received the spindle selection signal, it rotates with the previous speed, which makes the spindle rotates with different speed in different time. Each spindle has its own stop signal and enabling signal.

When №001#4 is set to 1, setting MSEN (№196#4) to 1 can start the multiple spindle control function.

The spindle control has several methods which are set by MSI (№196#7) as follows:

- Multiple spindle control method A

When SWS1 signal selects the 1<sup>st</sup> spindle, SIND signal is used to determine that the spindle analog voltage is controlled by PLC or CNC, R011 to R121 signals are used to set the spindle analog voltage. These signals do not influence the 2<sup>nd</sup> spindle.

Multiple spindle control method A is shown below.

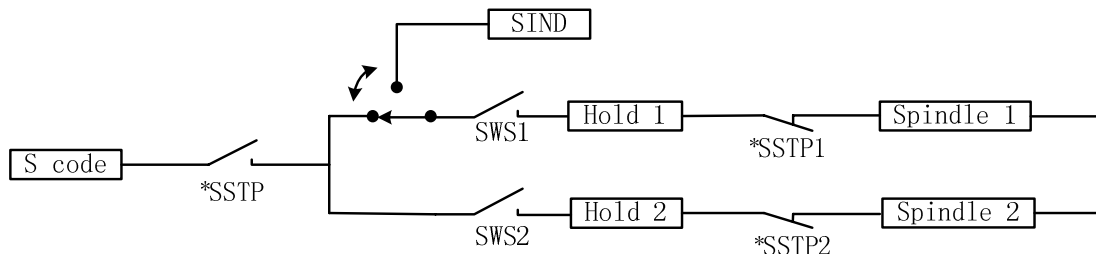

- Multiple spindle control method B

Each spindle has separate SIND signal.

When the spindle selection signal, the 1<sup>st</sup> spindle or the 2<sup>nd</sup> spindle SIND signal is set to 1, SIND signals separately determine each spindle to be controlled by PLC or CNC.

Multiple spindle control method B is shown below.

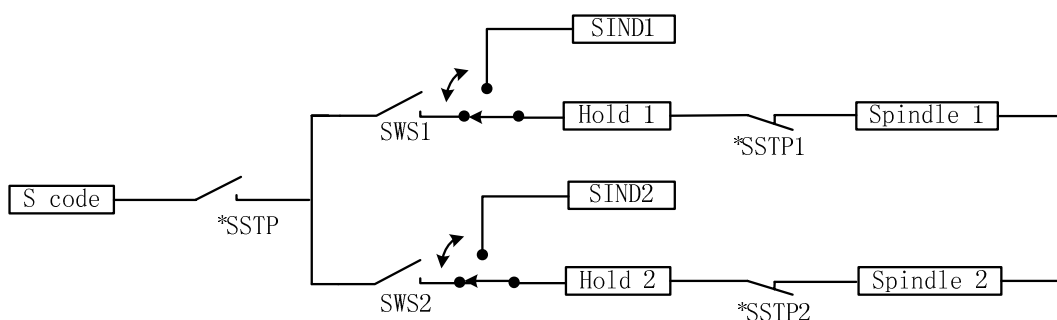

- Multiple spindle control function being invalid

When the multiple spindle control is invalid, the control method is shown below.

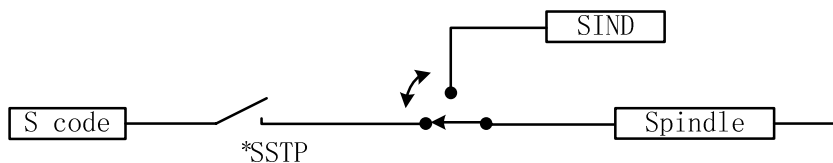

## 2.2.6 Cs contour control function

Controlling a spindle speed is called as the spindle rotation control (the spindle rotates by the speed command), and controlling the spindle position is called as the spindle contour control (the spindle rotates by the movement command). The function of the spindle contour control is that of Cs contour control. Being the servo feed axis, the spindle rotates and orients by the position movement command, and executes the interpolation with other feed axes to machine the contour curve.

## 2.3 Tool Function

### 2.3.1 Tool control

T functions of GSK980TDC: automatic tool change and executing tool offset. Control logic of automatic tool change is executed by PLC and tool offset is executed by NC.

Command format:

T□□○○

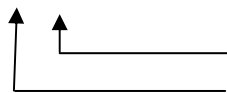

Tool offset number (00-32, the leading zero cannot be omitted)

Target tool number (01-32, the leading zero cannot be omitted)

Command function: The automatic tool post rotates to the target tool number and the tool offset of tool offset number commanded is executed. The tool offset number can be the same as the tool number, and also cannot be the same as it, namely, one tool can corresponds to many tool offset numbers. After executing tool offset and then T□□00, the system reversely offset the current tool offset and the system its operation mode from the executed tool length compensation into the non-compensation, which course is called the canceling tool offset, called canceling tool compensation. When the system is switched on, the tool offset number and the tool offset number displayed by T command is the state before the system is switched off.

Only one T command is in a block, otherwise the system alarms.

Toolsetting is executed to gain the position offset data before machining (called tool offset), and the system automatically executes the tool offset after executing T command when programs are running. Only edit programs for each tool according to part drawing instead of relative position of each tool in the machine coordinate system. If there is error caused by the wearing of tool, directly modify the tool offset according to the dimension offset.

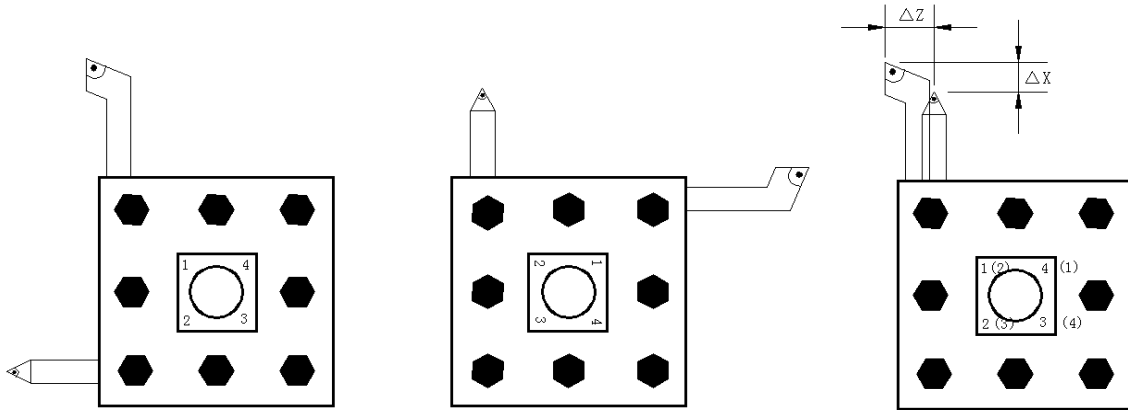

Fig.2-6 tool offset

The tool offset is used for the programming. The offset corresponding to the tool offset number in T command is added or subtracted on the end point of each block. Tool offset in X direction in diameter or radius is set by No.004 Bit4. For tool offset in diameter or radius in X direction, the external diameter is changed along with diameter or radius when the tool length compensation is changed.

Example: When the state parameter No.004 Bit4 is set to 0 and X tool length compensation value is 10mm, the external diameter of workpiece is 10mm; when No. 004 is set to 1 and X tool length compensation value is 10mm, the external diameter of workpiece is 20mm. Fig.2-5 is the course of creating, executing and canceling tool offset in traverse mode.

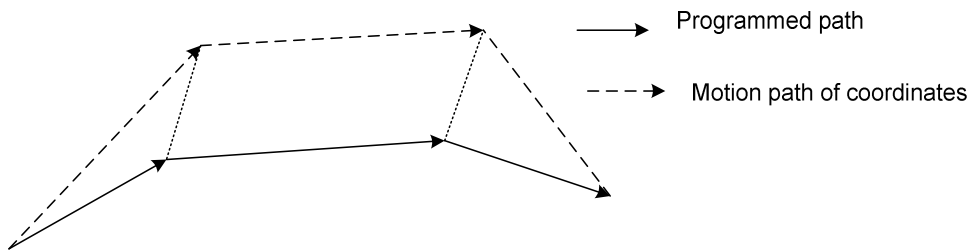

Fig. 2-7 Creation, execution and cancellation of tool length compensation

```
G01 X100 Z100 T0101; (Block 1, start to execute the tool offset)
G01 W150; (Block 2, tool offset Block 2, tool offset)
G01 U150 W100 T0100; (Block 3, canceling tool offset)
```

There are two methods defined by No.003 Bit4 to execute the tool length compensation:

Bit4=0: The tool length compensation is executed by the tool traversing;

Bit4=1: The tool length compensation is executed by modifying the coordinates;

Example:

Table 2-4

Tool offset number	X	Z
00	0.000	0.000
01	0.000	0.000
02	12.000	-23.000
03	24.560	13.452

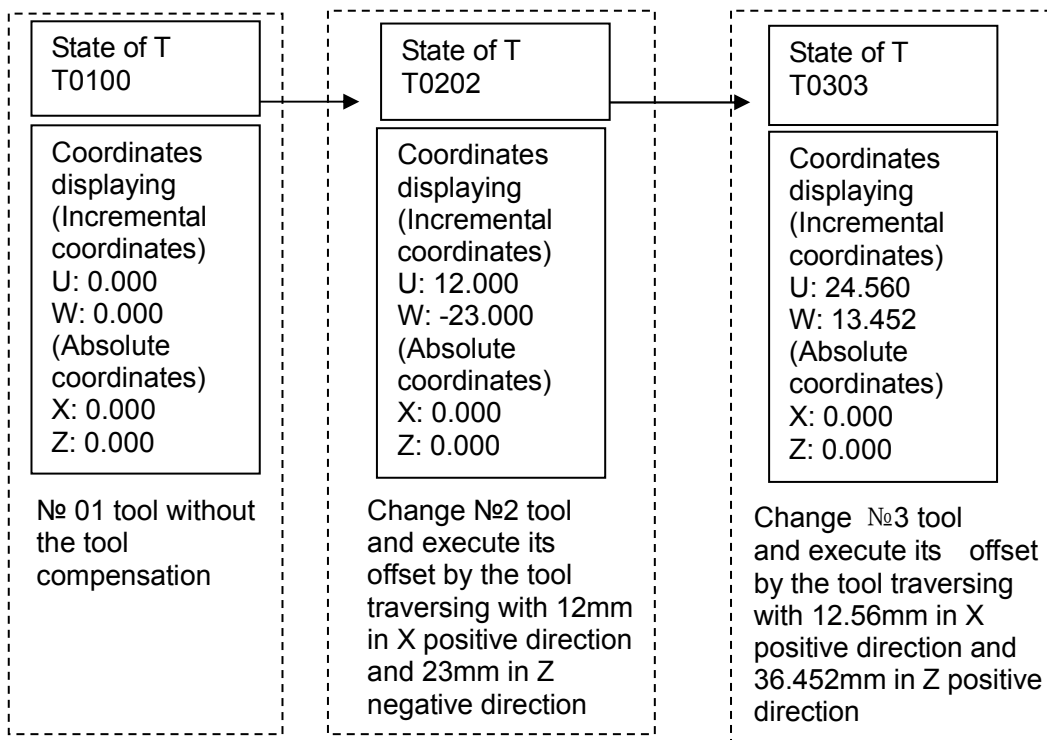

Fig. 2-7 Tool traversing mode

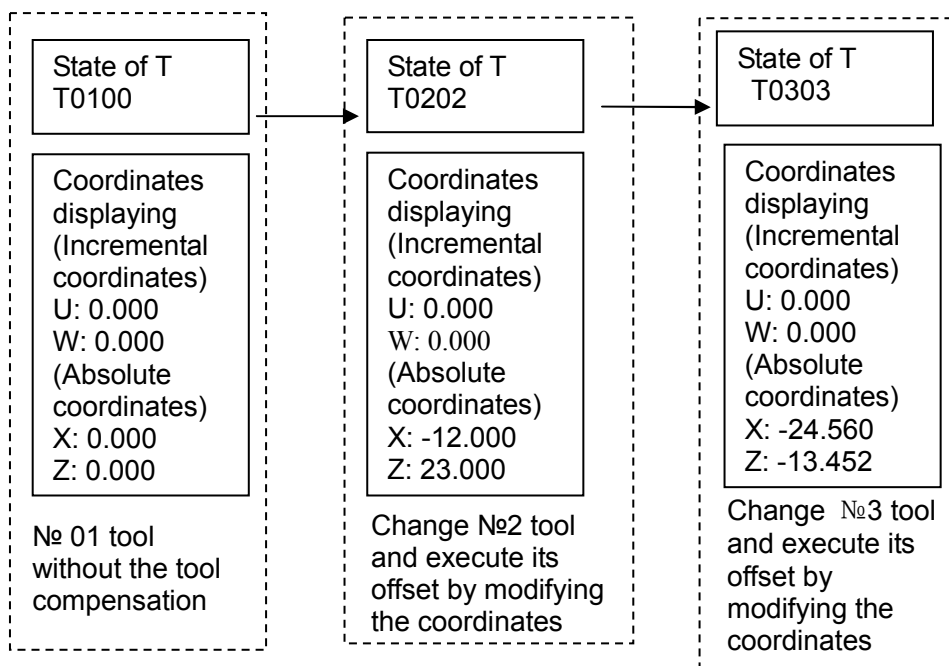

Fig. 2-8 Modifying the coordinates mode

In Edit and Auto mode, a sole T word in executing tool offset (it is not with the motion command in the same block) is relative to No.004 BIT3 setting (as Fig.2-6 and Fig.2-7). When No.003 Bit4=1 and a sole T command is executed, the tool offset number is displayed in poor, which is cleared out(tool offset number is still displayed in poor when tool offset is not executed for one axis, the previous bit of tool offset number is for X axis tool compensation and the next one is for Z axis tool compensation) after executing tool offset.

Example: When No.003 Bit4 is 1 and a sole T0101 is executed, the system displays after

executing Z axis as follows:



Executing a sole T0101 and tool offsets of two axes are not executed



Executing W0 after T0101, X tool offset is not executed but that of Z is done

When T command and the motion command are in the same block and execute tool offset by modifying coordinates, the motion command and T command are executed at the same time, the system executes by adding the current tool offset to coordinates of motion command and whether the traverse speed is employed the cutting feedrate or the rapid traverse speed defined by the motion command.

When T command and the motion command are in the same block and execute tool offset by traversing tool, the motion command or T command is executed separately. Firstly tool change is executed and then the motion command is executed. The tool offset is executed at current rapid traverse speed.

The tool offset is cancelled after one of the following operations is executed:

1. Execute T□□00 command;

- Execute G28 or manual machine reference point return (only the tool offset of coordinate axis which is executed machine reference point return is cancelled, and another one which is not executed machine reference point return is not cancelled);

When No.084 is not 1 (2~32) and target tool number is not equal to current display tool number, the control sequence and logic of tool post is defined by PLC ladder diagram after commanding T command, please see User Manual of machine tool manufacturer. GSK980TDc standard PLC ladder diagram defines as follows: clockwise rotation for selecting tool, counterclockwise rotation for tool post clamping, directly inputting tool selection signal for tool change. Please refer to III **INSTALLATION & CONNECTION**.

When the system is employed with line-up tool post, No.084 should be set to 1 and different tool number is executed by different tool offset as T0101, T0102, T0103.

### 2.3.2 Tool life management

#### 1. Starting tool life management function

The state parameter No.002 Bit0 (TLIF) is the market whether the tool life management function is valid or not, the corresponding tool life management window is not displayed when it is invalid.

002								Tool life management
-----	--	--	--	--	--	--	--	----------------------

- Bit 0 Tool life management function is not valid.
- 1 Tool life management function is valid.

#### 2. Tool life management display window

Press repetitively **OFFSET** into the tool life management display window **TOOL-LIFE**.

##### 1) “Tool compensation->tool life” window

The current window displays the life management data of current used tool life management and defined tool groups. The window is shown below:

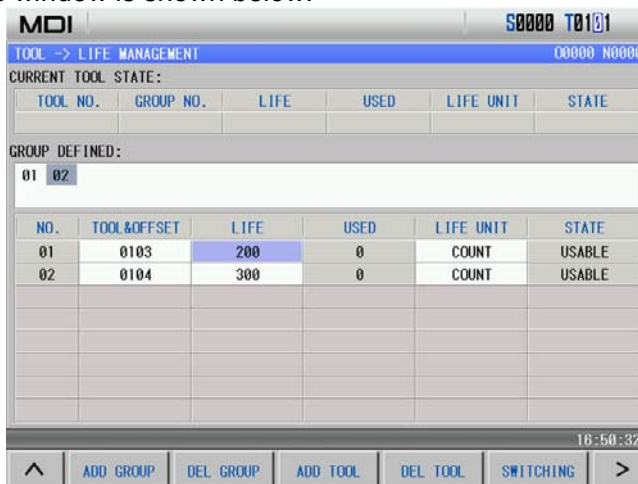

- Current tool state: display the current used tool life management data;
- Tool number: current used tool and tool compensation number;
- Group: the group where the tool is;

Life: tool life data, the specified value can be time or number of times according to the different count N value; press **COUNT CLR** to record the time or clear the times.

Used: used tool life data.

Life unit: count unit of tool life, N1 is the used time (unit: minute), N0 is the used times (unit: times) . Press **UNIT:COUNT**, **UNIT:MIN** to change the count unit of the tool.

State: display the tool state (0—not be used, 1—being used , 2—used, 3—skip) .

Press **SKIP TOOL** to change the tool state to skip when the tool is not used in the current window.

Defined group: It only display defined group number and the undefined group number is not displayed. The displayed group back lighted means that all tool life in this group is over.

### 2) Creating and displaying tool group number

A. In tool group state display window, press **ADD GROUP**, group number, **DATA INPUT** and the system display the tool group life data, and when the group does not exist, it is defined to the new group number( the parameter switch is ON in MDI mode).

Note: After the new group is defined, GSK980TDc will automatically define the first tool, for example, the new defined group number is 01, the display is as follows:

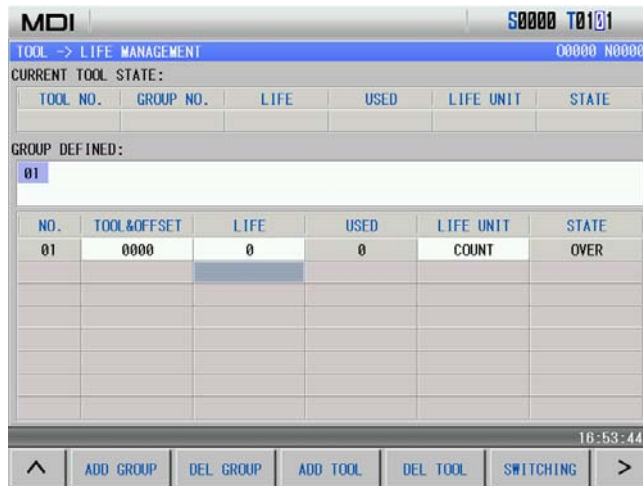

B. Press **SWITCHING** to move the cursor to Defined Group Number.

C. Press **←** or **→** to select the group number in Defined Group Number, and to gradually display content of each group number.

### 3. Definition of tool life data

There are two ways to set the tool life data: 1) compile NC programs and run the program setting; 2) input directly in the tool life management window.

#### 1) Compile NC programs and run program setting

Command format: G10 L3

Command function: set to be the tool life manage data input mode

Command format: G11

Command function: cancel the tool life management data input mode

Program	Meaning	Remark
O0020 (O0020)		T_: tool and tool offset number;



G10 L3;	Set to be the tool life management data input mod	
P01;	Tool group number, too group number setting range(1~32)	N_: tool life count mode, N0 is the used time(minute) to count tool life and N1 is the used number of times to count the tool life(unit: min)
T0101 L500 N0;	Tool number, life, mode(number of times) setting	
T0201 L600 N1;	Tool number, life and mode(min) setting	
P02;	Another tool group number	
T0303 L200 N0;		L_: tool life data, the specified value can be time or number of times according to the different count N value
T0304 L300 N0;		
G11;	Cancel the tool life management data input mode	
M30;		

**Note 1:** The tool group numbers specified by P may not be the continuous, but it is better to gradually increase the sequence number to easily search the tool group number.

**Note 2:** The tool life is 0 when the life data L\_ is omitted, and the tool mode is 0 (minute) when the specified mode N\_ is omitted, at the time, the system only counts and does not alarm for the output.

**Note 3:** Other commands between G10 L3 and G11 are ignored.

**Note 4:** Running the tool life preset program (such as O0020) completely clear all previous life data and preset the life data according to the program requirements.



**Note 5:** Prevent the life data from being modified manually when the part programs are running until the run state stops (except for running the tool life preset programs).

**Note 6:** All tool life data is stored when power-down.

## 2) Input tool life management data in the tool life management window

Input directly the tool life management data in tool compensation- >tool life window in MDI mode, parameter switch ON and 3-level operation limit.

### A. alter data:

In tool compensation -> tool life window, press  to move the tool to the life position, input directly data, such as 500, press  to confirm the input. Press     to complete data input (tool offset, life) .

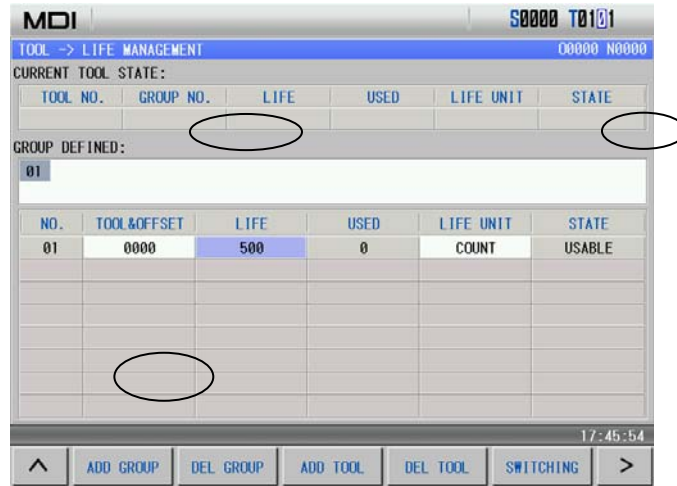

**B. Inserting data:**

Insert any serial number in the current page, press **ADD TOOL** —> [01~08] —> **DATA INPUT**, insert a new line, and the initial value definition is as follows:

Serial number	Tool offset	Life	Used	Mode	State
N	0000	0	0	0	Over

a) Insert the front and the previous serial number moves backward.

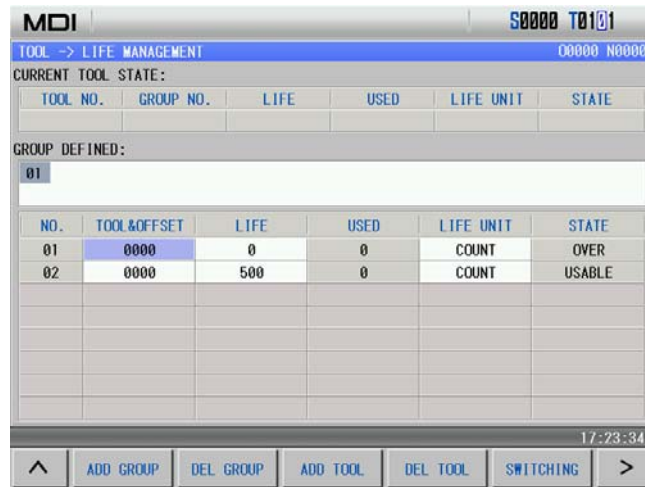

b) Insert the middle and the previous sequence number moves backward.

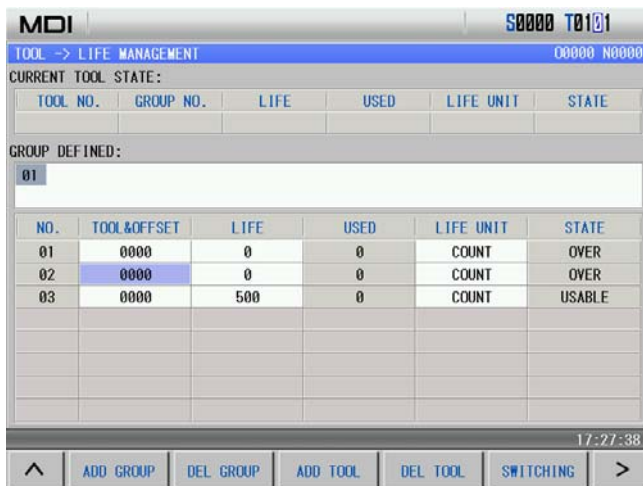

c) Insert behind

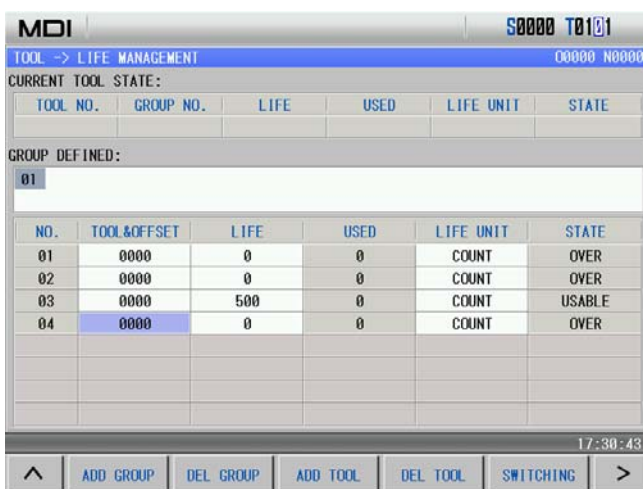

**C. Delete data:**

a) Delete data in all groups.

In tool compensation-> tool life window, press  to delete all defined data.

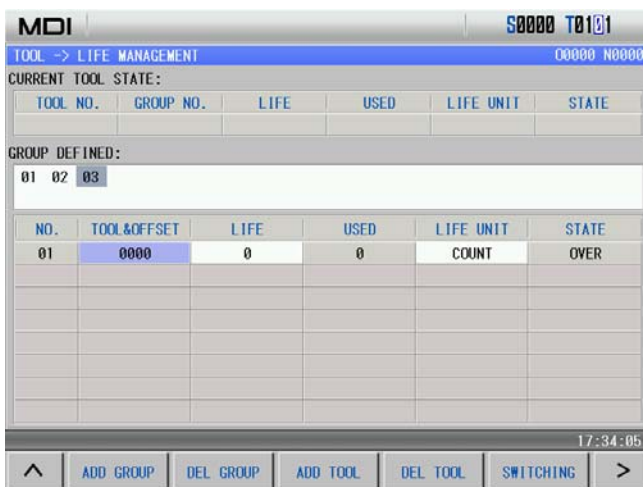

**Before operation**

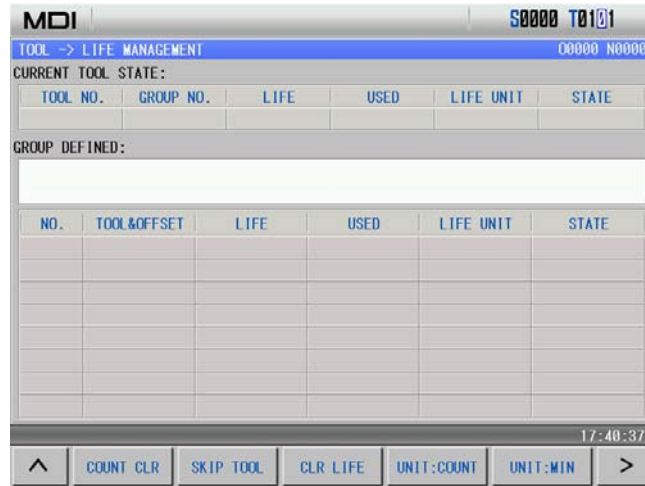

After operation

b) Delete data in any group

Press **DEL GROUP** ———> input serial number [02] ———> **DATA INPUT** ;

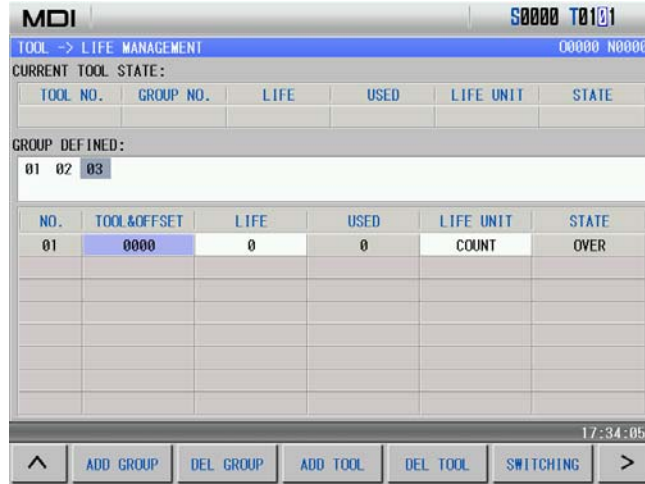

Before operation

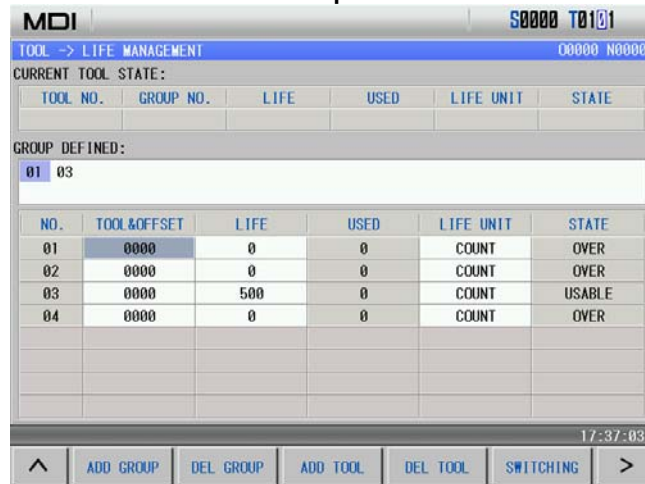

After deletion

c) Delete any serial number in the current page(the parameter switch is ON)

Press **DEL TOOL** ———> input serial number [04] ———> **DATA INPUT**

MDI S0000 T0101  
TOOL -> LIFE MANAGEMENT 00000 N0000  
CURRENT TOOL STATE:  
TOOL NO. GROUP NO. LIFE USED LIFE UNIT STATE

GROUP DEFINED:  
01

NO.	TOOL&OFFSET	LIFE	USED	LIFE UNIT	STATE
01	0000	0	0	COUNT	OVER
02	0000	0	0	COUNT	OVER
03	0000	500	0	COUNT	USABLE
04	0000	0	0	COUNT	OVER

17:30:43  
ADD GROUP DEL GROUP ADD TOOL DEL TOOL SWITCHING >

Before deletion

MDI S0000 T0101  
TOOL -> LIFE MANAGEMENT 00000 N0000  
CURRENT TOOL STATE:  
TOOL NO. GROUP NO. LIFE USED LIFE UNIT STATE

GROUP DEFINED:  
01

NO.	TOOL&OFFSET	LIFE	USED	LIFE UNIT	STATE
01	0000	0	0	COUNT	OVER
02	0000	0	0	COUNT	OVER
03	0000	500	0	COUNT	USABLE

17:45:21  
ADD GROUP DEL GROUP ADD TOOL DEL TOOL SWITCHING >

After deletion

#### 4. Tool life function use

Command format:

Txx99: end of current used tool group, start the tool and execute the life management in XX group.

Txx88: cancel the tool offset in XX group

Two examples are as follows:

Application example:

O0000 (O0000)	
...	
T0199;	End of previous tool group, and start the tool in 01 group
...	
T0188;	Cancel tool offset in 01 group(current used tool offset)
...	
T0508;	Use No.05 tool and 08 tool offset without life management
...	
T0500;	Cancel No.05 tool offset
...	

T0299;	End of No.05 tool and start the tools in 02 group
...	
T0199;	End of tools in No.02 group, start tools in No.02 group, and start the next tool when there are many tools in No.01 group.
...	

**5. Tool life count:**

When the count result is for the used life value being more than or equal to the setting value of the life data, the next tool group number selects the standby tool in the commanded selection tool group and the new selected tool will be counted, the count will be continuously executed and the system alarms to output to PLC when all tool life in the tool groups reaches and there is no standby tools. Executing the counting in MDI mode is determined by No.002 Bit3 (MDITL).

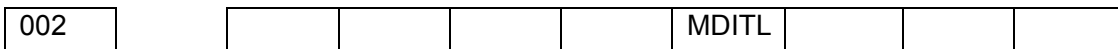

MDITL=0 Tool life management is invalid in MDI mode.

MDITL=1 Tool life management is valid in MDI mode.

The tool life count has two methods including time and number of times.

**A. Time count**

Use the time (minute) to count the tool life in cutting feed mode(such as G01, G02, G03, G32, G33, G34 and so on), and do not count it in G00, G04, single block stop, machine lock, auxiliary lock, dry run and so on.

**B. Number of times count**

There are two methods about the number of times count which is determined by No.002 Bit2 (LIFC).

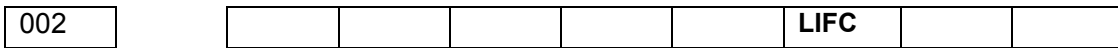

LIFC=0 Tool life management count mode 1

Execute the tool select (Txx99) to change the tool number, execute the count in the cutting feed mode (except for machine lock, auxiliary lock, dry run state). The count is not executed when the tool number is changed and the system is not in the cutting feed mode.

Application example:

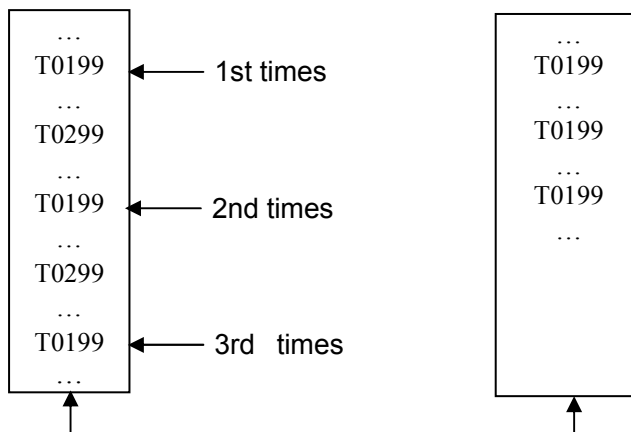

Use 3 times in 01 tool group

use once in 01 tool group

LIFC=1 Tool life management count 2

The tool group adds when the machining program runs to M30(M99), when the system

resets halfway, the number of time does not add, the count is not executed in machine lock, auxiliary lock and dry run mode.

#### 6. G, F signals relevant to tool life function

##### a) Tool change signal TLCH (F064 #0)

[Type] output signal

[Function] inform PLC that the last tool life ends of in this group

[Output condition] the signal is set to 1, the last tool life in one group ends, all other tool life ends.

##### b) New tool selection signal TLNW (F064 #1)

[Type] output signal

[Function] inform a new tool in some tool group has been selected

[Output condition] the signal is set to 1 and a new tool in some tool group has been selected.

##### c) Tool change reset signal TLRST (G048 #7)

[Type] input signal

[Function] clear all execution data

[Operation] when the signal is set to 1, the control unit clears the used tool life data of in all groups; the tool state is reset to the unused.

**Note: when the automatic operation signal OP is "0", the tool change reset signal TLRST is valid.**

##### d) Tool skip signal TLSKP (G048 #5)

[Type] input signal

[Function] use the following two methods to change the tools which have not reached the life:

- 1) When LIFJ (NO.2#4) is set to 1, the selection signals of the tool group number (G47#0~#4) specify the tool group number, then, the tool skip signal TLSKP becomes "1", the next T command skips the tool which is being used of the current group, and the tool which life has not reach in the group specified by G47#0~#4 is used.
- 2) When LIFJ (NO.2#4) is set to 0, the group numbers specified by the tool group number signal (G47#0~#4) are invalid, the tool skip signal TLSKP becomes "1", the machine skips to the next tool in the current used tool group.

[Operation] when the signal is set to 1, the operation described in [Function] is executed.

**Note: When cycle start light signal(STL) and feed pause light signal(SPL) must be "0", inputting TLSKP signal is valid.**

##### e) Tool group number selection signal TL01~TL16 (G47#0~#4)

[Type] input signal

[Function] when TLSKP is input, using the tool group selection signal TL01~TL16 specifies the tool group number with the binary system. The specified tool group number =  $G47\#4\sim\#0 + 1$ .

[Operation] specify the selected tool group

## CHAPTER 3 G COMMANDS

### 3.1 Commands

G command consists of command address G and its following 1~2 bits command value, used for defining the motion mode of tool relative to the workpiece, defining the coordinates and so on. Refer to G commands as Fig. 3-1.

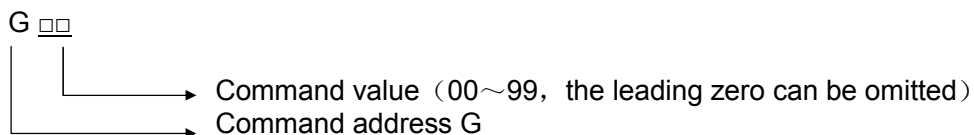

G words are divided into 9 groups (00, 01, 02, 03, 06, 07, 12, 14, 16, 21). Except that commands in the group 01 and 00 are not in the same block, G words in the different groups can be input to the same block and the last one is valid when two or more G words in the same group are input. The words in the different groups without the same parameter (word) can be in the same block and their functions are valid without sequence at the same time. The system alarms when G words do not belong to Table 3-1 or they are optional functions without being supplied.

Table 3-1 G command list

Word	Group	Function	Remark
G00		Rapid traverse movement	Initial modal G command
G01	01	Linear interpolation	Modal G commands
G02		Circular interpolation(CW)	
G03		Circular interpolation(CCW)	
G05		Three-point circular interpolation	
G6.2		Ellipse interpolation (CW)	
G6.3		Ellipse interpolation (CCW)	
G7.2		Parabola interpolation (CW)	
G7.3		Parabola interpolation (CCW)	
G32		Thread cutting	
G32.1		Rigid thread cutting	
G33		Z tapping cycle	
G34		Variable pitch thread cutting	
G90		Axial cutting cycle	
G92		Thread cutting cycle	
G84		End rigid tapping	
G88		Side rigid tapping	
G94		Radial cutting cycle	
G04	00	Dwell time preset	Non-modal G commands
G7.1		Cylinder interpolation	
G10		Data input	
G11		Data input cancel	
G28		Machine reference point automatic return	
G30		Machine 2nd, 3rd , 4th reference point	
G31		Skip interpolation	
G36		Automatic tool compensation X	
G37		Automatic tool compensation Z	



G50		Setting workpiece coordinate system	
G52		Setting local coordinate system	
G65		Macro command	
G70		Finishing cycle	
G71		Axial roughing cycle	
G72		Radial roughing cycle	
G73		Closed c	
G74		Axial grooving cycle	
G75		Radial grooving cycle	
G76		Multiple thread cutting cycle	
G20	06	Inch select	Modal G command
G21		Metric select	Initial mode G command
G96	02	Constant surface speed ON	Modal G command
G97		Constant surface speed OFF	Initial mode G command
G98	03	Feed per minute	Initial mode G command
G99		Feed per rev	Modal G command
G40	07	Cancel cutter radius compensation	Initial mode G command
G41		Tool nose radius compensation left contour (option)	Modal G command
G42		Tool nose radius compensation right contour(option)	
G66	12		Modal G command
G67			
G54	14	Workpiece coordinate system 1	Modal G command
G55		Workpiece coordinate system 2	
G56		Workpiece coordinate system 3	
G57		Workpiece coordinate system 4	
G58		Workpiece coordinate system 5	
G59		Workpiece coordinate system 6	
G17	16	XY plane	Modal G command
G18		ZX plane	Initial mode G command
G19		YZ plane	Modal G command
G12.1	21	Polar coordinate interpolation	Non-modal G command
G13.1		Polar coordinate interpolation cancel	

### 3.1.1 Modal, non-modal and initial mode

G commands are divided into group 00, 01, 02, 03, 06, 07, 16, 21.

After G commands are executed, their defined functions and states are valid until they are changed by others in the same group, which commands are called modal G commands. After the modal G words are executed, and before their defined functions and states are changed, the G command cannot be input again when they are executed by the following block.

The defined function and state are valid one time after G command is executed, and the G word must be input again when it is executed every time, which command is called non-modal G command.

After the system is switched on, the valid modal G commands which are not executed their functions or states are called initial mode G command. Take it as the initial mode G command to be executed when it is not be input after the system is switched on.

### 3.1.2 Omitting words

To simplify the programming, their command values are reserved after executing words in Table 3-2. If the words are contained in the previous blocks, they cannot be input when the words are used with the same values and definitions in the following blocks.

Table 3-2

Command address	Function	Initial value when power-on
U	Cutting depth in G71	No.51 parameter value
U	Move distance of X tool retraction in G73	No.53 parameter value
W	Cutting depth in G72	No.51 parameter value
W	Move distance of X tool retraction in G73	No.54 parameter value
R	Move distance of tool retraction in G71, G72 cycle	No.52 parameter value
R	Cycle times of stock removal in turning in G73	No.55 parameter value
R	Move distance of tool retraction after cutting in G74, G75	No.56 parameter value
R	Allowance of finishing in G76	No.60 parameter value
R	Taper in G90, G92, G94, G96	0
(G98) F	Feedrate per minute(G98)	No.30 parameter value
(G99) F	Feedrate per rev (G99)	0
F	Metric pitch(G32, G92, G76)	0
I	Inch pitch(G32, G92)	0
S	Spindle speed specified(G97)	0
S	Spindle surface speed specified(G96)	0
S	Spindle speed switching value output	0
P	Finishing times of thread cutting in G76; Tool retraction width of thread cutting in G76 Angle of tool nose of thread cutting in G76;	No.57 parameter value No.19 parameter value No.58 parameter value
Q	Min. cutting value in G76	No.59 parameter value

**Note 1:** For the command addresses with functions (such as F, used for feedrate per minute, feedrate per revolution and metric pitch and so on), they can be omitted not to input when executing the same function to definite words after the words are executed. For example, after executing G98 F\_ without executing the thread command, the pitch must be input with F word when machining metric thread.

**Note 2:** They can be omitted not to input when the address characters X(U) , Z(W) are the coordinates of end point of block and the system defaults the current absolute coordinates in X or Z direction to the coordinate value of end point of block.

**Note 3:** The corresponding words must be input when the command addresses which are not in Table 3-2 are used.

Example 1:  
O0001;

G0 X100 Z100; (rapid traverse to X100 Z100; the modal G0 is valid)  
 X20 Z30; (rapid traverse to X20 Z30; the modal G0 is not input)  
 G1 X50 Z50 F300; (linear interpolation to X50 Z50, feedrate 300mm/min; the modal G1 is valid)  
 X100; (linear interpolation to X100 Z50, feedrate 300mm/min; Z coordinate is not input and is the current coordinates Z50; F300 is kept, G1 is modal and is not input)  
 G0 X0 Z0; (rapid traverse to X0 Z0 and the modal G0 is valid)

M30;

Example 2:

O0002;  
 G0 X50 Z5; (rapid traverse to X50 Z5)  
 G04 X4; (dwell 4 seconds)  
 G04 X5; (dwell 5 seconds again, G04 is non-modal and is needed to input again)  
 M30;

Example 3 (the first run after power-on) :

O0003;  
 G98 F500 G01 X100 Z100; (Feedrate per minute 500mm/min in G98)  
 G92 X50 W-20 F2 ; (F value is a pitch and must be input in thread cutting)  
 G99 G01 U10 F0.01 (Feedrate per revolution in G99 must be input again)  
 G00 X80 Z50 M30;

### 3.1.3 Related definitions

In the user manual, the definitions of Word are as follows except for the especial explanations:

Starting point: position before the current block runs;  
 End point: position after the current block ends;  
 X: X absolute coordinates of end point;  
 U: different value of absolute coordinates between starting point and end point;  
 Z: Z absolute coordinates of end point;  
 W: different value of absolute coordinates between starting point and end point;  
 F: cutting feedrate.

## 3.2 Rapid Traverse Movement G00

**Command format:** G00 X(U) \_\_ Z(W) \_\_;

**Command function:** X, Z rapidly traverses at the respective traverse speed to the end points from their starting point. G00 is initial command as Fig.3-1.

X, Z traverses at the respective traverse speed, the short axis arrives the end point and the length axis continuously moves to the end point and the compound path may be not linear.

**Command specification:** G00 is initial mode;

X, U, Z, W range:  $\pm 99999999 \times$  least input increment;

Can omit one or all command addresses X(U), Z(W). The coordinate values of starting point and end point are the same when omitting one command address; the end point and the starting point are in the same position when all are omitted. X, Z are valid, and U, W are invalid when X, U, Z and W are in the same one block. X, U, Z, W rang is referred to Table 1-2 of Section 1.4.1, unit: mm/inch.

Command path:

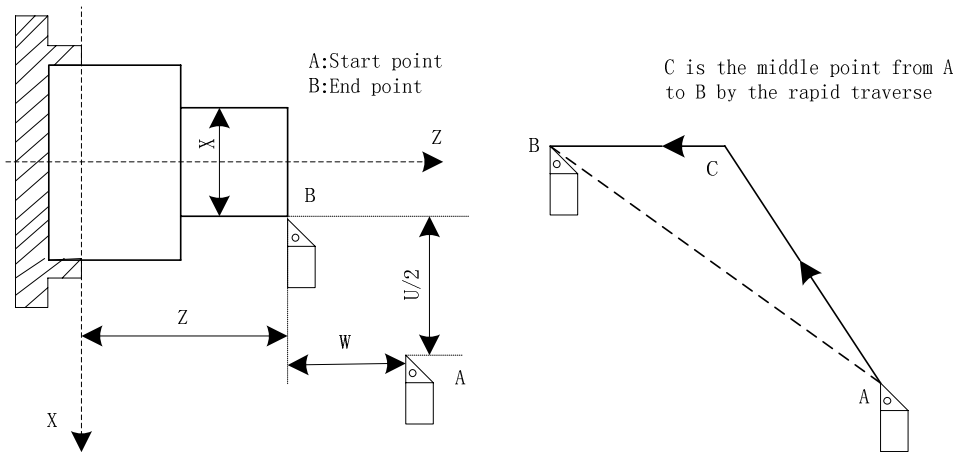

Fig. 3-1

The respective rapid traverse speed of X, Z is defined by the system parameter No.022, No.023, and their traverse speed can be changed by rapid override key on the machine control panel.

Example: The tool rapidly traverses to B from A as Fig. 3-2.

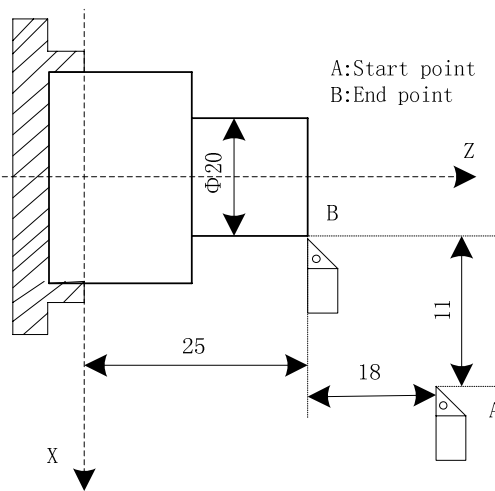

Fig. 3-2

- G0 X20 Z25; (absolute programming)
- G0 U-22 W-18; (incremental programming)
- G0 X20 W-18; (compound programming)
- G0 U-22 Z25; (compound programming)

### 3.3 Linear Interpolation G01

**Command format:** G01 X(U)\_ Z(W)\_ F\_;

**Command function:** The movement path is a straight line from starting point to end point as Fig.3-3.

**Command specification:** G01 is modal.

Can omit one or all command addresses X (U), Z (W). The coordinate values of starting point and end point are the same when omitting one command address; the end point and the starting point are in the

same position when all are omitted. X, U, Z, W range is referred to Table 1-2 of Section 1.4.1, unit: mm//inch.

F command value is the vector compound speed of X and Z instantaneous speed and the actual cutting feedrate is the product between the feedrate override and F command value.

After F command value is executed, it has been reserved unless the new one is executed. Do not repeat it when the following G commands adopt functions of F word. Its range is referred to Table 1-2.

**Note:** In G98, F max. value cannot exceed the value set by the data parameter No.027(upper speed of cutting feed), otherwise, the system alarms.

**Command path:**

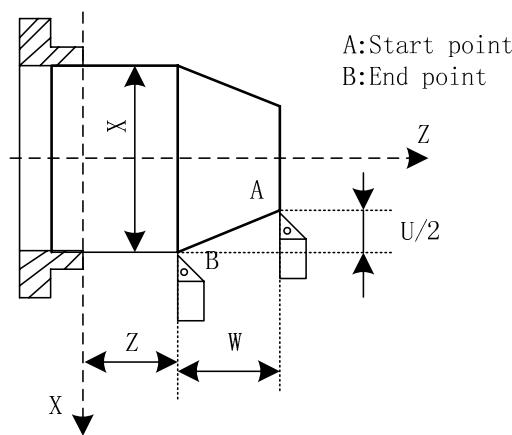

Fig. 3-3

Example: Cutting path from  $\Phi 40$  to  $\Phi 60$  as Fig.3-4:

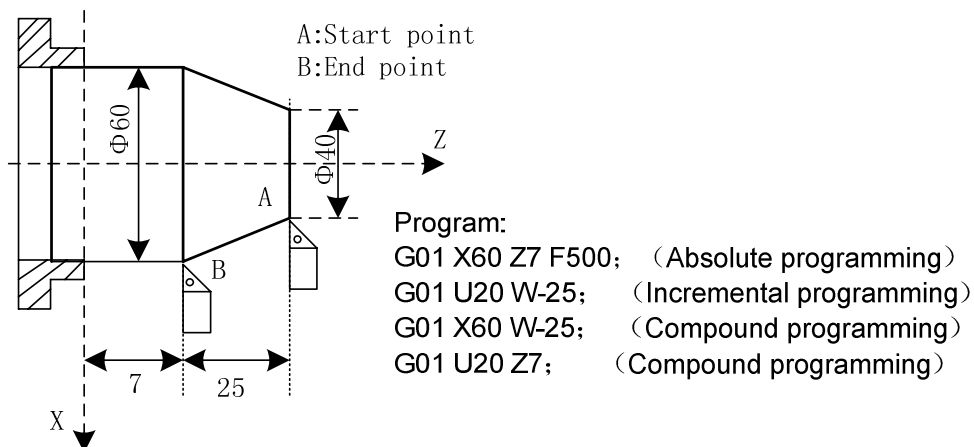

Fig. 3-4

### 3.4 Circular Interpolation G02, G03

Command format:  $\left. \begin{matrix} G02 \\ G03 \end{matrix} \right\} \begin{matrix} X(U) \_ \\ Z(W) \_ \end{matrix} \left\{ \begin{matrix} R \_ \\ I \_ K \_ \end{matrix} \right.$

**Command function:**

G02 movement path is clockwise (rear tool post coordinate system)/counterclockwise (front tool post coordinate system) arc from starting point to end point as Fig. 3-5.

G03 movement path is counterclockwise (rear tool post coordinate system)/clockwise (front tool post coordinate system) arc from starting point to end point as Fig. 3-6.

**Command path:**

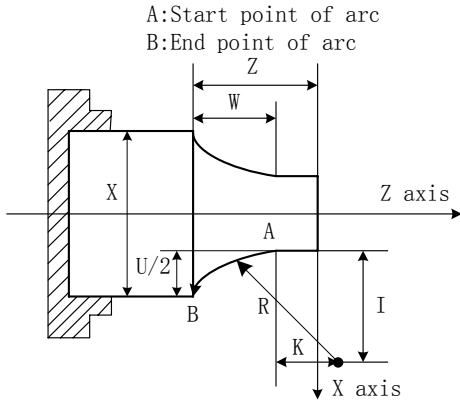

G02 path  
Fig. 3-5 G02 path

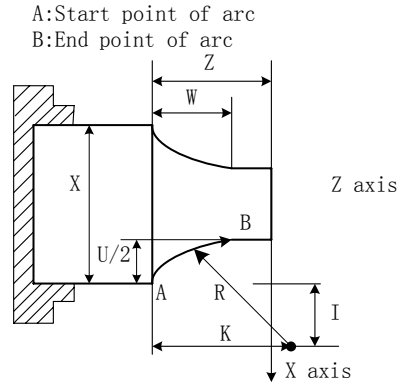

G03 path  
Fig.3-6 G03 path

**Command specification:**

G02, G03 are modal,

R is arc radius, range:  $\pm 99999999 \times$  least input increment;

I: X difference value between circle center and starting point of arc in radius;

K: Z difference value between circle center and starting point of arc;

Center point of arc is specified by address I, K which separately corresponds to X, Z, I, K expresses the vector (it is the increment value) from starting point to center point of arc as the following figure;

I=Coordinates of center point-that of starting point in X direction; K= Coordinates of center point-that of starting point in Z direction;

I, K are with sign symbol. When directions of I, K are the same as those of X, Z, they are positive, otherwise, they are negative.

X, U, Z, W, R, I, K range is referred to Table 1-2 of Section 1.4.1, unit: mm/inch.

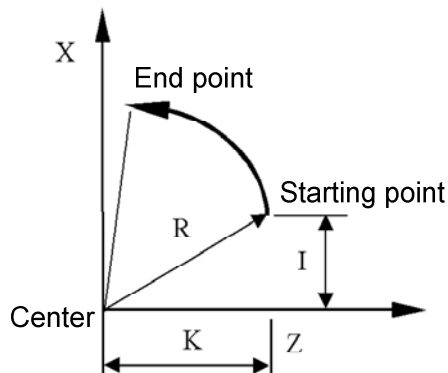

Fig. 3-6-1

Arc direction: G02/G03 direction (clockwise/counterclockwise) is opposite on the front tool post

coordinate system and the rear one as Fig.3-7:

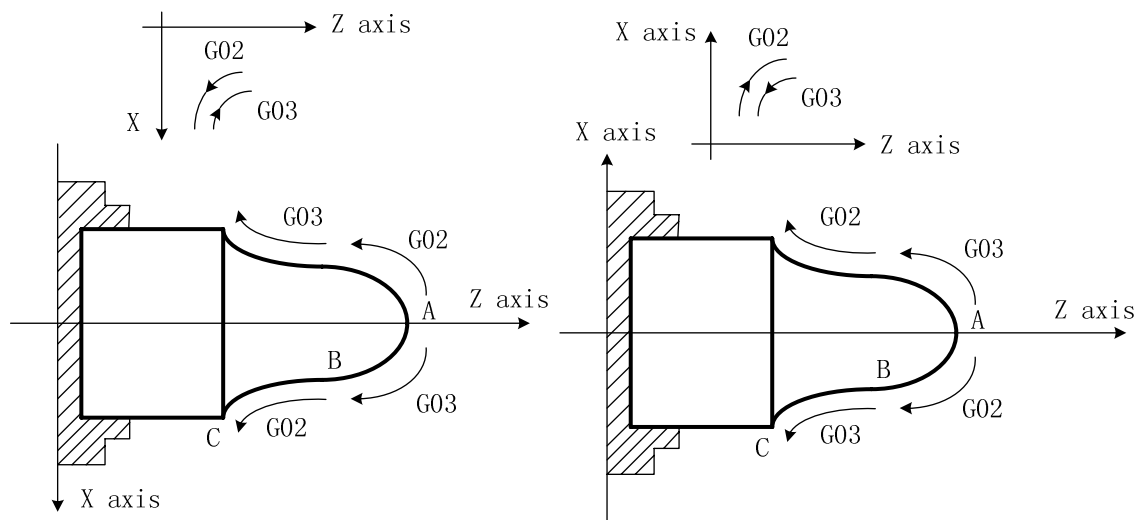
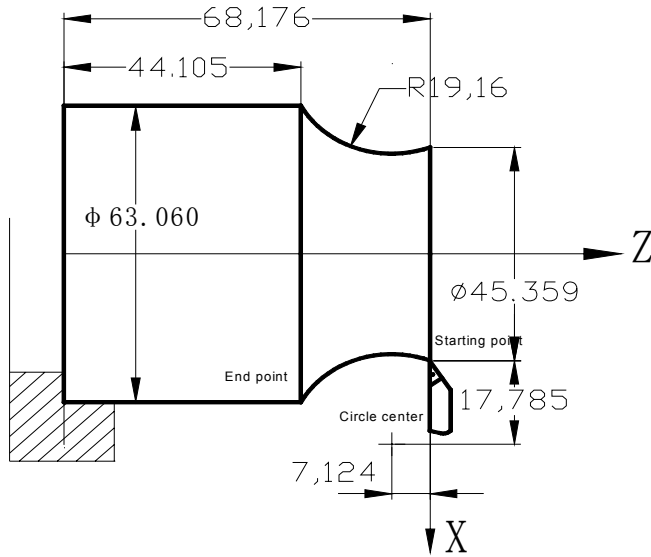

Fig. 3-7

**Notes:**

- When  $I = 0$  or  $K = 0$ , they can be omitted; one of  $I$ ,  $K$  or  $R$  must be input, otherwise the system alarms.
- $R$  is valid and  $I$ ,  $K$  are invalid when they are input at the same time.
- $R$  value must be equal to or more than half distance from starting point to end point, and the system alarms if the end point is not on the arc defined by  $R$  command;
- Omit all or one of  $X(U)$ ,  $Z(W)$ ; coordinates of starting point and end point of this axis are the same when omitting ones, the path is a full circle( $360^\circ$ ) in  $G02/G03$  when center point are specified by  $I,K$ ; the path is  $0(0^\circ)$  when center point is specified by  $R$ .
- $R$  should be used for programming. The system executes in  $R = \sqrt{I^2 + K^2}$  to ensure starting point and end point of arc path are the specified ones in  $I, K$  programming.
- When the distance from center point to end point is not equal to  $R(R = \sqrt{I^2 + K^2})$  in  $I,K$  programming, the system automatically adjusts position of center point to ensure starting point and end point of arc path are the specified ones; when the distance from center point to end point is more than  $2R$ , and the system alarms.
- Arc is less than  $360^\circ$  when  $R$  is commanded, the arc is more than  $180^\circ$  when  $R$  is negative, and it is less than or equal to  $180^\circ$  when  $R$  is positive.

Example: Arc cutting path from  $\Phi 45.25$  to  $\Phi 63.06$  shown in Fig. 3-8.



Program:  
 G02 X63.060 Z-24.071 R19.16 F300 ; or  
 G02 U17.701 W-24.071 R19.16 F300 ; or  
 G02 X63.060 Z-24.071 I17.785 K-7.124 ; or  
 G02 U17.701 W-24.071 I17.785 K-7.124 F300

Fig. 3-8

Compound programming in G02/G03:

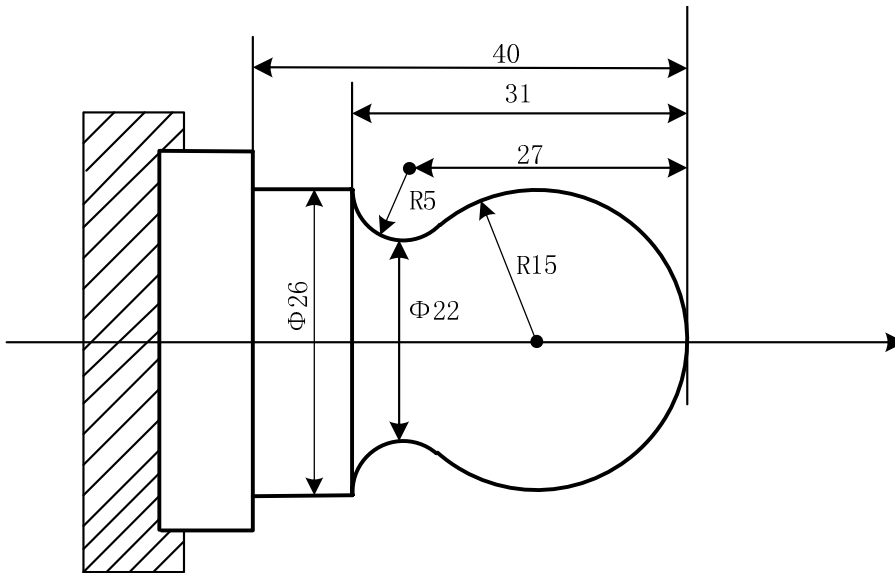

Fig. 3-9 Circular programming example

Program: O0001  
 N001 G0 X40 Z5; (Rapidly traverse)  
 N002 M03 S200; (Start spindle)  
 N003 G01 X0 Z0 F900; (Approach workpiece)  
 N005 G03 U24 W-24 R15; (Cut R15 arc)  
 N006 G02 X26 Z-31 R5; (Cut R5 arc)  
 N007 G01 Z-40; (Cut  $\phi$ 26)  
 N008 X40 Z5; (Return to starting point)  
 N009 M30; (End of program)

### 3.5 Three-point Circular Interpolation G05

Command format: G05 X(U)\_\_\_ Z(W)\_\_\_ I\_\_\_ K\_\_\_ F\_\_\_



**Command function:** when you do not know positions of the circular center of arc and the radius but coordinates of three points on the arc, you can use G5 to confirm the arc direction through the middle position between the initial point and end point.

**Command specification:** G05 is modal;

I: incremental coordinate value(X) (radius value, direction) of the middle point where the circular passes corresponding to the starting point, range:  $\pm 99999999 \times$  least input increment;

K: incremental coordinate value(Z, direction) of the middle point where the circular passes corresponding to the starting point, range:  $\pm 99999999 \times$  least input increment; as Fig.3-10:

X, U, Z, W, R, I, K range is referred to Table 1-2 of Section 1.4.1, unit: mm/inch.

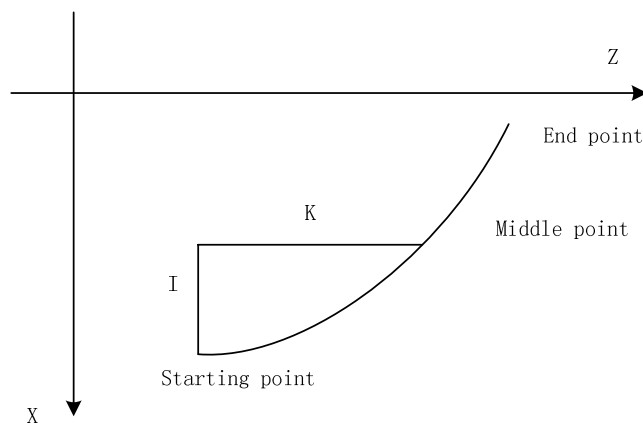
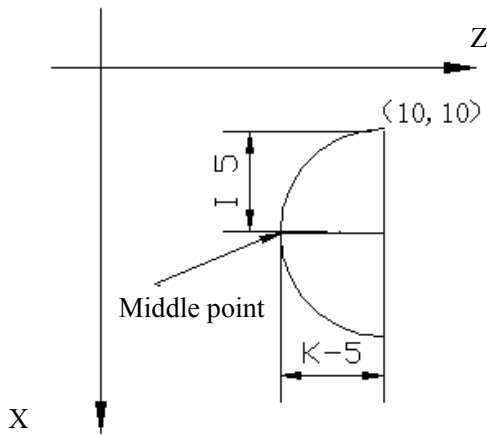

Fig. 3-10

**Notes:**

- Middle point: any one point except for the starting point and end point on the arc;
- The system alarms when the three points are in the same line;
- I=0 when it is omitted, K=0 when it is omitted; the system alarm when they are omitted simultaneously;
- The meanings of I, K are similar to their displacement values of the circle center coordinates corresponding to starting point ones in G02/G03;
- G05 does not execute the whole circle machining;

Example: (machining semi-circle)



Program:  
G0 X10 Z10  
G05 X30 Z10 I5 K-5

Fig. 3-10-1

### 3.6 Ellipse Interpolation G6.2, G6.3

**Command format:** G6.2 } X(U)\_\_\_ Z(W)\_\_\_ A\_\_\_ B\_\_\_ Q\_\_\_  
G6.3 }

**Command function:** G6.2 motion path is the CW(rear tool post coordinates)/CCW(front tool post coordinates) ellipse.

G6.3 motion path is the CCW(rear tool post coordinates)/CW(front tool post coordinates) ellipse.

**Command path:**

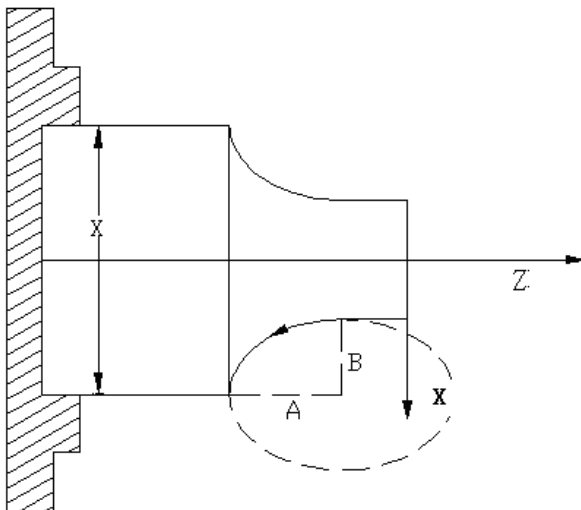

G6.2 path sketch map

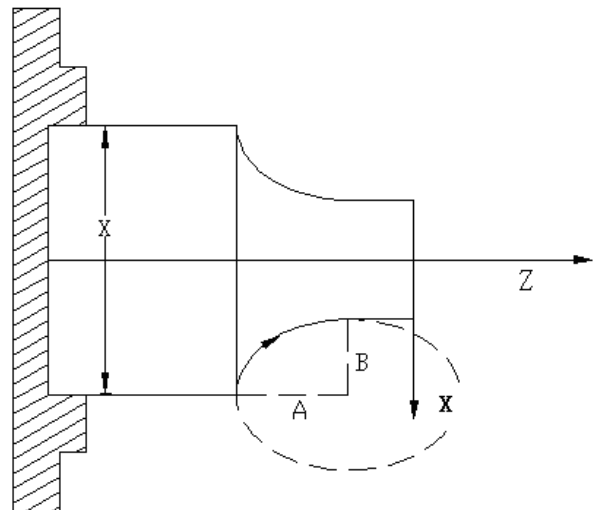

G6.3 path sketch map

**Explanation:**

A: Length of ellipse's long radius (0<A<= 99999.999mm, no sign )

B: Length of ellipse's short radius (0<B<= 99999.999mm, no sign )

Q: angle between the long axis and Z coordinate system of ellipse (CCW 0-99999999, unit: 0.001°)

**Ellipse direction:** defined by that of G6.2/G6.3, they are the reverse in the front and rear tool post coordinates.

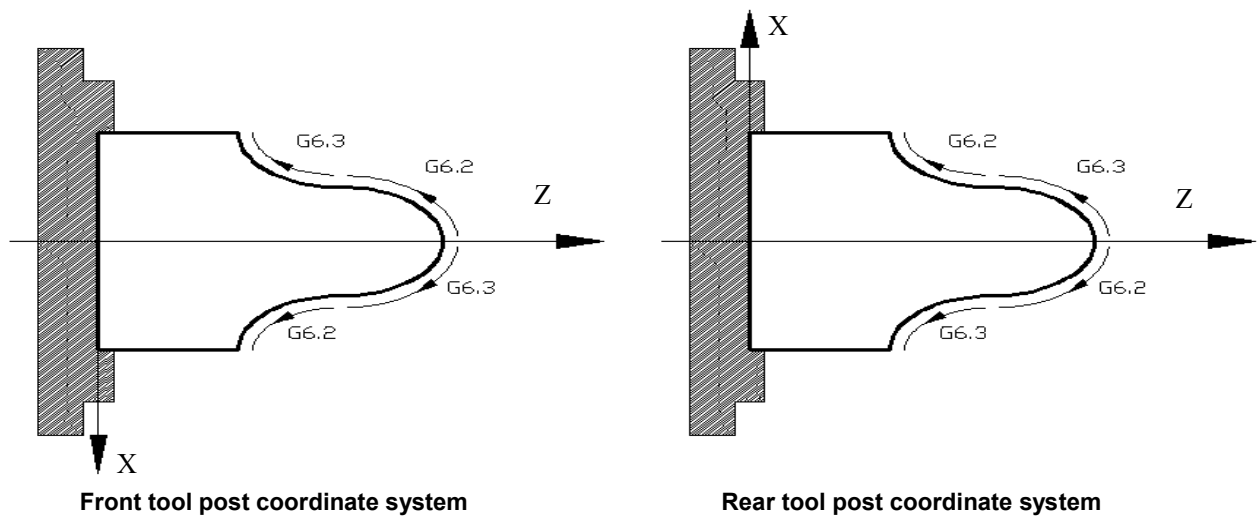

**Q value:** It is a motion angle from the Y positive direction overlooking XZ plane when the tool CW rotating in the positive direction to the long axis of the ellipse in the right hand rectangular Cartesian coordinate system as follows:

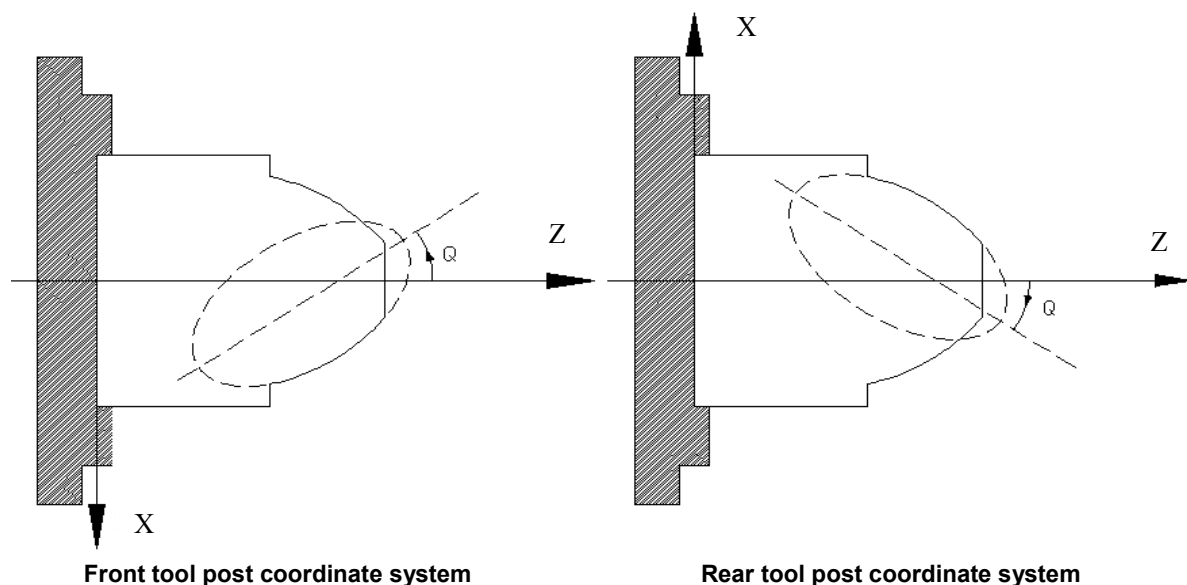

**Notes:**

- A, B are not modal parameter. They are 0 when they are not input. When A=0 or B=0, the system alarms; when A=B, G02/G03 is executed to machine the circular;
- Q value is a non-modal parameter, and it must be specified when it is used. When it is omitted, it is 0°, the long and the short axis are parallel or coincident ;
- Q unit is 0.001°, the angle between it and Z is 180°. When Q 180000 is input, Q180 or Q180.0 is input, they are 0.18°;
- When the distance between the starting point and end point is longer than the long axis, the system alarms;
- One or both of X(U), Z(W) can be omitted; omitting one of them indicates that the starting point and the end point of the axis are consistent; omitting the both indicates they are the same one;

- Only machines the ellipse which is less than 180°(including 180°);
- G6.2/G6.3 are used to the compound cycle G70—G73, and their notes are the same those of G02, G03;
- G6.2, G6.3 are used to C tool compensation and their notes are the same those of G02, G03.

Example: machine from  $\Phi 43.14$  to  $\Phi 63.82$ :

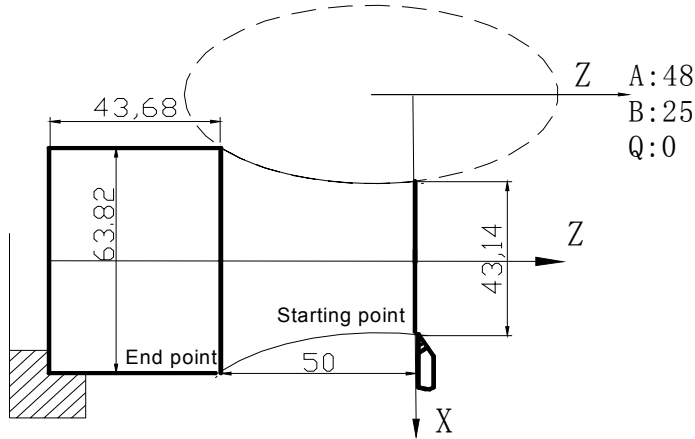

Program:

G6.2 X63.82 Z-50.0 A48 B25 Q0 ; or  
G6.2 U20.68 W-50.0 A48 B25 ;

Example: machine from  $\Phi 43.14$  to  $\Phi 63.82$ :

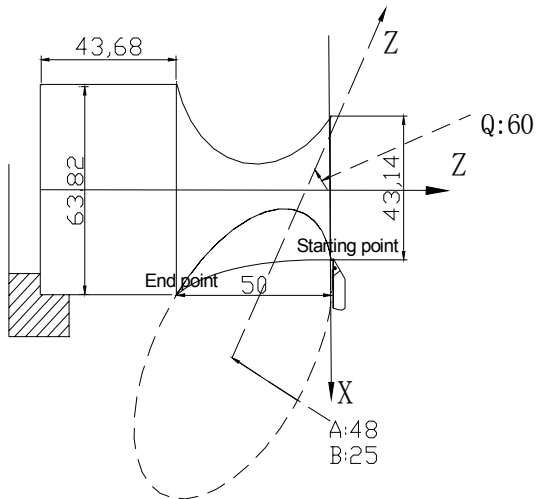

Program:

G6.2 X63.82 Z-50.0 A48 B25 Q60000; or  
G6.2 U20.68 W-50.0 A48 B25 Q60000;

G6.2/G6.3 compound program example :

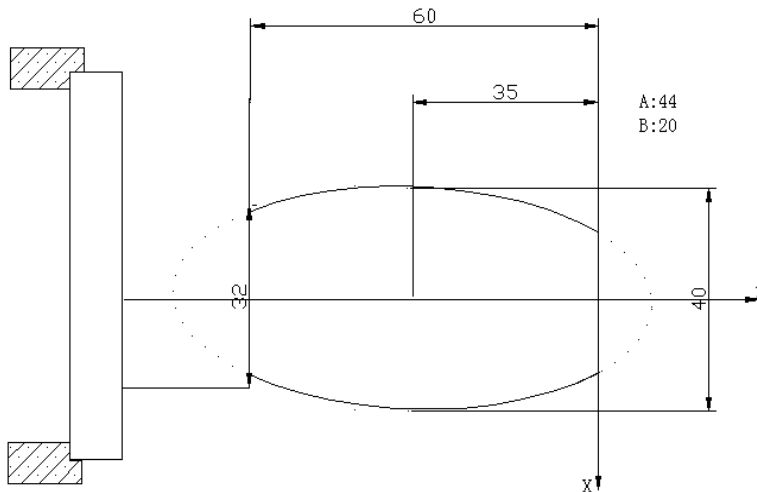

Fig. 3-11

- Program: O0001  
 N001 G0 X60 Z5; (rapidly position)  
 N002 M03 S200; (spindle ON)  
 N003 G01 X24.24 Z0 F100; (approach the workpiece)  
 N005 G6.3 X40 W-35 A44 B20; (cutting A44 B20 ellipse block)  
 N006 G01 X32 Z-60;  
 N007 Z-79;  
 N008 G0 X60  
 N009 Z5; (return to the starting point)  
 N0010 M30; (end of program)

### 3.7 Parabola Interpolation G7.2, G7.3

**Command format:**  $\left. \begin{array}{l} \text{G7.2} \\ \text{G7.3} \end{array} \right\} \begin{array}{l} \text{X(U)}\_ \text{Z(W)}\_ \text{P}\_ \text{Q}\_ \end{array}$

**Command function:** G7.2 motion path is the CW (rear tool post coordinates)/CCW(front tool post coordinates) parabola.

G7.3 motion path is the CCW (rear tool post coordinates)/CW(front tool post coordinates) parabola.

**Command path:**

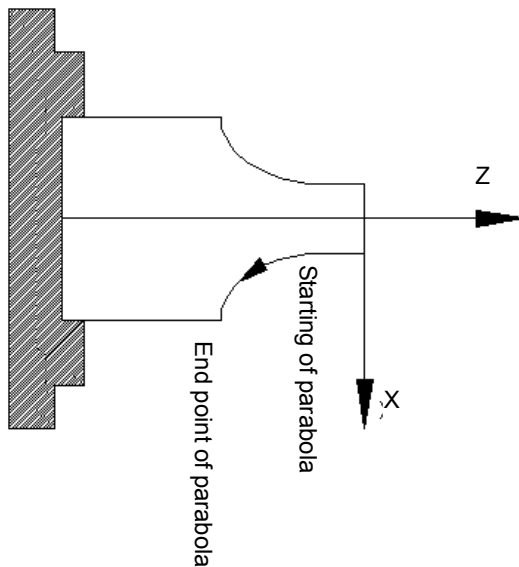

G7.2 path sketch map

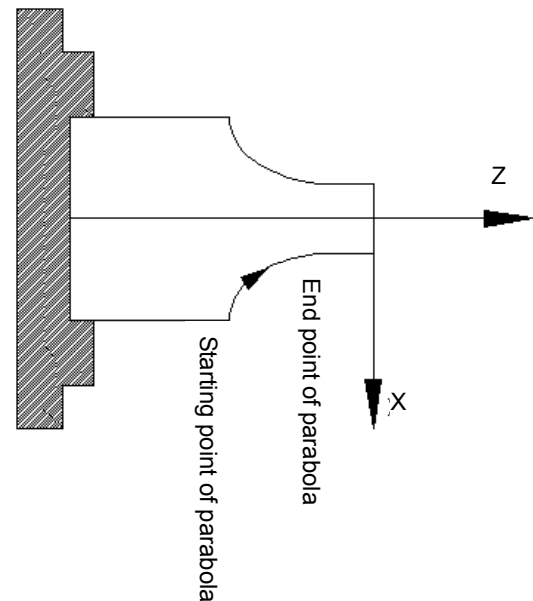

G7.3 path sketch map

**Explanation:**

G7.2, G7.3 are modal;

P is in the parabola standard equation  $Y^2=2PX$ , its range: 1~9999999(unit: 0.001mm, without sign);

Q is the angle between the symmetrical axis of parabola and Z, and its range: 0~99999999 (unit: 0.001°) .

**Parabola direction:** G7.2/7.3 interpolation directions in the front tool post coordinate system and the rear are reverse.

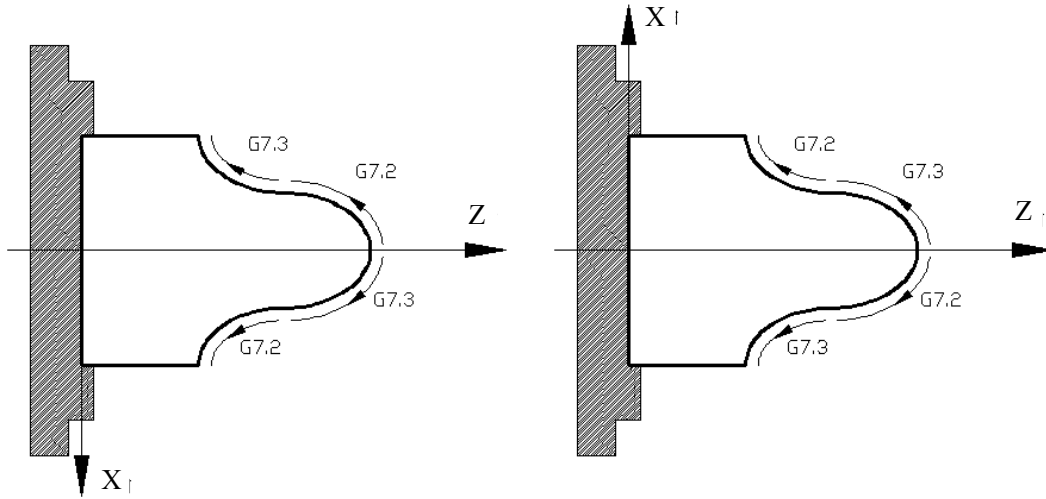

Front tool post coordinate system

Rear tool post coordinate system

**Q value:** it is a motion angle from the Y positive direction overlooking XZ plane when the tool CW rotating in the positive direction to the long axis of the parabola in the right hand rectangular Cartesian coordinate system as follows:

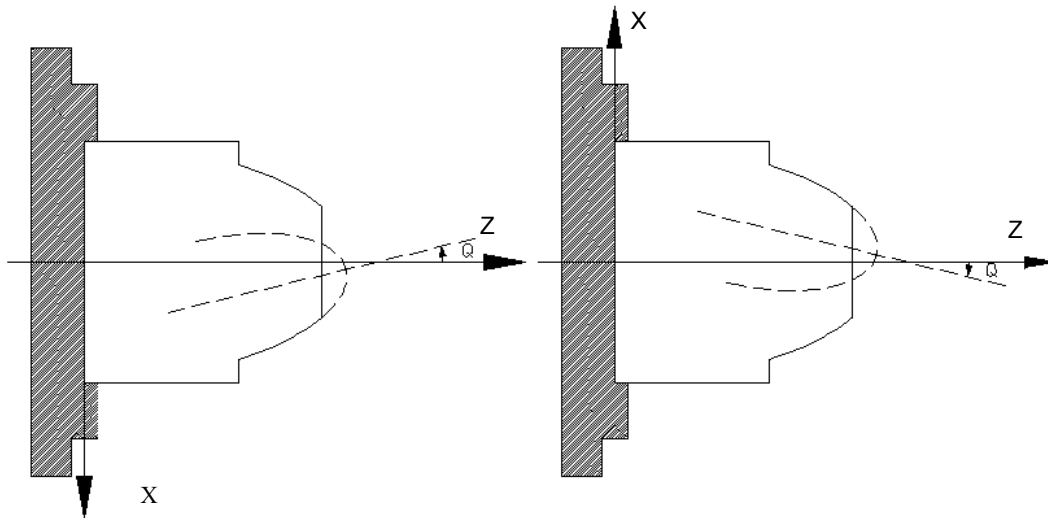

Front tool post coordinate system

Rear tool post coordinate system

**Notes:**

- P cannot be 0 or omitted, otherwise the system alarms;
- P has no sign. If it has the negative sign, its absolute value is executed;
- Q can be omitted, at the time, the symmetrical axis of the parabola is parallel with or coincident with Z ;
- The system alarms when the straight line on which the starting point and the end point is parallel with the symmetrical axis of the parabola;
- G7.2, G7.3 can be used to the compound cycle G70~G73, and their notes are the same those of G02, G03;
- G7.2, G7.3 are used to C tool compensation, and their notes are the same those of G02, G03;  
Example: when the parabola P=100(the least increment is 0.0001mm), its symmetrical axis is parallel with Z. Its machining sketch map and programming are as follows:

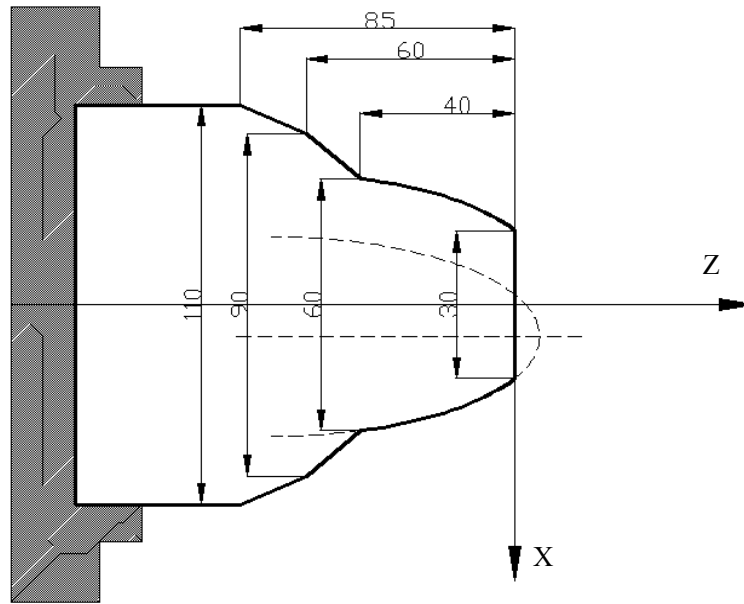

Program:

```
O0001(O0001)
G00 X120 Z100 T0101 M03 S800;
G00 X10 Z10;
G00 X0;
G01 Z0 F120 M08;
X30;
G7.3 X60 Z-40 P10000 Q0;
G01 X90 Z-60;
X110 Z-85;
X120;
M09;
G00 X120 Z100 M05 S0;
M30;
```

### 3.8 Plane Selection G17~G19

**Command format:**

G17.....XY plane

G18.....ZX plane

G19.....YZ plane

**Command function:** use G commands to select the plane of the arc interpolation or the one of the cutter compensation

**Command explanation:** G17, G18, G19 are modal, and the plane does not change in the block without the command.

**Notes:**

- Firstly set the basic axis Y when the system selects G17, G19 plane;
- Cannot switch the planes in C tool compensation;
- G71~G76, G90, G92, G94 can be used in G18 plane;
- The plane selection code can be in the same block with G codes in the other groups;
- The movement command is not relevant to the plane selection;

- Diameter or radius programming: currently, because there is only one bit parameter No 1.2 to select the diameter or the radius programming and is valid to only X axis, Z and Y axis use the only radius programming in G2, G3, and X axis is selected by the parameter;
- The tool nose direction of C tool compensation is 0 in G17, G19.

### 3.9 Polar Coordinate Interpolation G12.1, G13.1

**Command format:** G12.1---start polar coordinate interpolation method- (can be written to G112) --- (1)

```
G98
G01 X__ C__
G04 X__
G41/G42 G1 X__ C__
G6.2/G6.3 X__ C__ A__ B__ Q__
G7.2/G7.3 X__ C__ A__ B__ Q__
G05 X__ C__ I__
G02/G03 X__ C__ R__
G40 G1 X__ C__
G65/G66/G67
```

--- (2) available command

G13.1---cancel polar coordinate interpolation method- (can be written to G113) --- (3)

**Command function:** Polar coordinate interpolation is a function that exercises contour control in converting a command programmed in a Cartesian coordinate system to the movement of a linear axis (movement of a tool) and the movement of a rotary axis (rotation of a workpiece). This method is useful in cutting a front surface and grinding a cam shaft on the machine.

**Command explanation:** G12.1, G13.1 are non-modal

Linear axis: X or Z, Y or 4<sup>th</sup> or 5<sup>th</sup> axis

Rotary axis: axes except for feed axis(Y or 4<sup>th</sup> or 5<sup>th</sup> axis)

Before starting the polar coordinate, set the linear axis and the rotary axis by No.235 and No.236.

Taking example of the linear axis X and the rotary axis 5<sup>th</sup>.

Polar coordinate interpolation plane: G12.1 starts the polar coordinate interpolation mode and selects a polar coordinate interpolation plane(below), and the polar coordinates are completed in the plane.

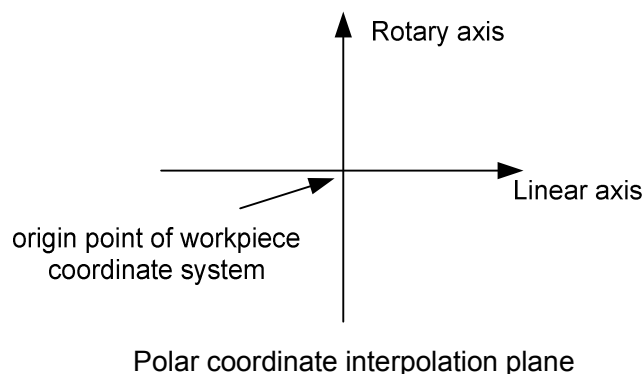



**Note:** After G12.1 is used, the previous plane is cancelled and the system enters the polar coordinate interpolation plane, and after G13.1 is used, the plane is cancelled and the previous is recovered;

After the system resets, it cancels the polar coordinate interpolation and recovers the previous plane, and the cursor returns to the beginning of the program.

**Programming format:** create the rectangular coordinate system in the polar coordinate interpolation plane below:

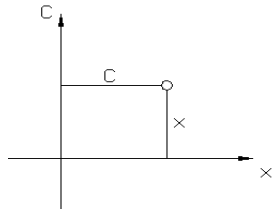

X: distance of linear axis, unit: mm/inch;

C: distance of rotary axis, unit: mm/inch;

The linear axis can use the diameter programming and the rotary axis uses only the radius;

The polar coordinates in the polar coordinate interpolation plane is prepared below:

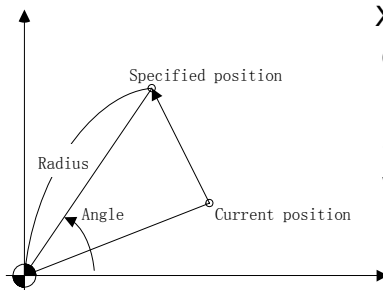

X: length between current tool and the origin, its unit: mm/inch;

C: angle unit of current rotary axis: deg;

G16 is the polar coordinates of current coordinates being complied, and G15 is to cancel it. The Cartesian coordinate system is used without G16. G16/G15 is valid in the only polar coordinate interpolation.

The radius programming is applied to the linear axis and the rotary axis below:

• **Length compensation:** the length compensation is not applied to the rotary axis, and the length offset should be command before G12.1 mode, and cannot be changed in the polar coordinate interpolation.

• **Tool radius compensation:** the tool nose direction is 0.

• **Machine motion:** the linear axis is vertical to the rotary axis.

• **Circular interpolation in the interpolation plane:** the address of the arc radius is determined by the 1st axis(linear axis) in the interpolation plane.

- When the linear axis is X or its parallel axis, I and J are used in Xp-Yp plane
- When the linear axis is Y or its parallel axis, J and K are used in Xp-Zp plane
- When the linear axis is Z or its parallel axis, K and I are used in Zp-Xp plane

The arc radius can also use R command.

• **Command speed:** tangential speed in the polar coordinate plane.

When the tool approaches the center of the workpiece, the speed component of C axis exceeds its maximum cutting feedrate(set by No.27). F value is calculated by the followings:

**L:** the distance (mm) between the center of the tool and that of the workpiece

**R:** maximum cutting feedrate of C axis (deg/min)

Conclusion:  $F < L \times R \times \pi / 180$  (mm/min)

It is suggested that the workpiece should not be machined near the polar because the feedrate override must be changed in some occasion to avoid the overload of the rotary axis.

• **Movement along the axis in the non polar coordinate interpolation plane in the polar**

**coordinate interpolation mode:** The tool traverses normally along these axes and is not relevant to the polar coordinate interpolation, the parameter specifies one axis to execute the polar coordinate interpolation before executing the polar coordinate interpolation, the axis which does not specify the polar coordinate can moves along the normal path in G00 or G01, but the axis which polar coordinate is not specified is disabled(i.e. the block is ignored and the axis does not move) in arc or ellipse command.

- **Coordinates display:** After G12.1 is executed, the absolute coordinates, the machine coordinates and the incremental coordinates display the actual position of the tool, the remaining distance to move in a block is displayed based on the coordinates in the polar coordinate interpolation plane, and after G13.1 is executed or the reset is done, the coordinates in the current system plane is displayed.

**Note 1:** G12.1, G13.1 are in Group 21, G12.1, G13.1, G16, G15 are in a separate line.

**Note 2:** The tool change cannot be executed in G12.1-G13.1, the tool change operation and the positioning followed by the tool change must be performed before G12.1.

**Note 3:** The system cannot start the polar coordinate interpolation during C tool compensation or in G99, otherwise, it alarms.

**Note 4:** When G12.1 is commanded, the tool position of the polar coordinate interpolation is at the angle of 0.

Example:

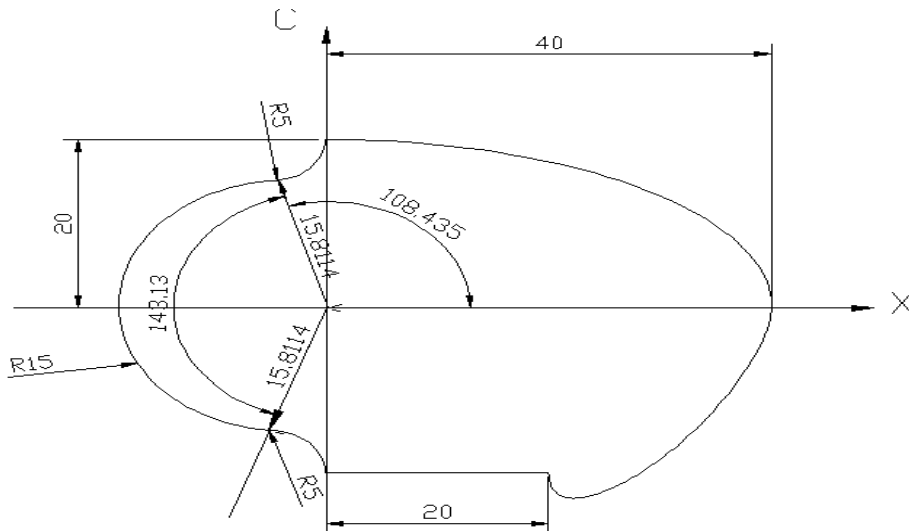

```
O0000 (O0000)
T0101
G0 X80 C0 W0
G12.1
G6.3 X0 C20 A40 B20 F1000
```

```
G2 X-10 C15 R5
G3 X-10 C-15 R15
```

} replace to

G16----the followings are the length and the angle programming  
 G2 X15.8114 C108.435 R5  
 G3 X15.8114 C251.565 R15  
 G15-----cancel the above programming mode and the followings are Cartesian coordinate programming

```
G2 X0 C-20 R5
```

G1 X40 C-20  
 G7.3 X80 C0 P10000 Q60000  
 G13.1  
 M30

### 3.10 Cylindrical Interpolation G7.1

**Command function:** The amount of travel of a rotary axis specified by an angle is once internally converted to a distance of a linear axis along the outer surface so that linear interpolation or circular interpolation can be performed with another axis. After interpolation, such a distance is converted back to the amount of travel of the rotary axis. The cylindrical interpolation function allows the side of a cylinder to be developed for programming (below).

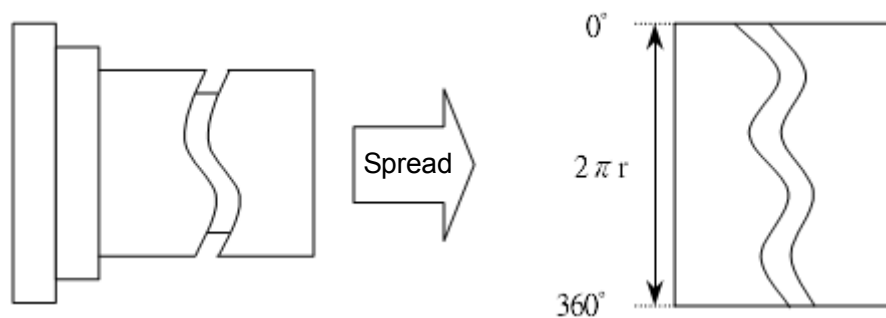

**Command format:** G07.1Cc ; (enable/cancel cylindrical interpolation mode)

Cc: the radius of the cylinder;

Radius ≠ 0: starts the cylindrical interpolation mode

Radius = 0: cancels the cylindrical interpolation mode

- (1) A coordinate command from starting the cylindrical interpolation mode to completing its cancellation is a cylindrical coordinate system;
  - G07.1 Cxxxx(cylindrical radius value); .....starting the cylindrical interpolation
  - .....;
  - .....; .....The coordinate command in the range is a cylindrical coordinate system
  - .....;
  - G07.1 C0; .....cancel the cylindrical interpolation
- (2) G7.1 is non-modal ;
- (3) The cylindrical interpolation mode is cancelled in power-on and reset;
- (4) The rotary axis executes a program by an angle, a rolling function of a rotary axis in the cylindrical interpolation mode will be automatically invalid, and a programming command value must be more than  $360^{\circ}$  when the interpolation range is more than one circle;
- (5) The coordinate value can be absolute or incremental;
- (6) The tool nose radius compensation G41, G42 can be executed and their tool nose directions are 0;
- (7) A feedrate specified in the cylindrical interpolation mode is a speed on the developed cylindrical surface, its unit: mm/min or inch/min;

**Restrictions:**

- (1) In the cylindrical interpolation mode, the linear G1, the arc G2, G3 (arc radius is specified by R, its unit is mm or inch) , ellipse G6.2, G6.3, parabola G7.2, G7.3 interpolation;
- (2) G00 positioning operation cannot be executed in a cylindrical interpolation mode;
- (3) Before executing the cylindrical interpolation mode, the tool nose radius compensation mode which is being executed is cancelled, the tool compensation is started or completed in a cylindrical interpolation mode;
- (4) Miscellaneous function T cannot be used in the cylindrical interpolation mode;
- (5) The feedrate in the cylindrical interpolation mode specifies G98(feed per minute);
- (6) G50 setting workpiece coordinate system in the cylindrical interpolation mode cannot be used;
- (7) A rotary axis and a linear axis of only current cylinder in the cylindrical interpolation is specified;

**Plane selection:** Before a cylindrical interpolation, the plane where the interpolation is should be selected firstly, one axis in the plane is a linear axis in the cylindrical interpolation and another is a corresponding linear axis of the developed rotary axis (below).

Basic coordinate system:

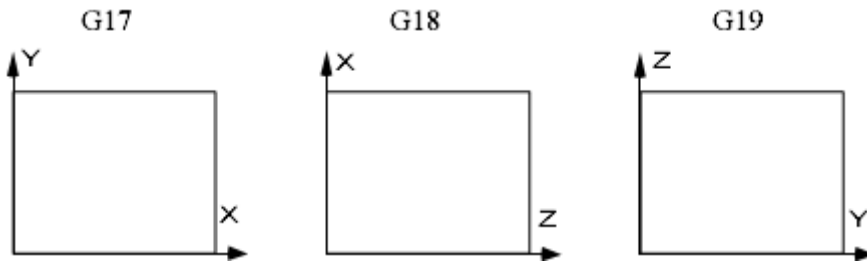

The rotary axis is set to X or its parallel axis in the cylindrical interpolation mode:

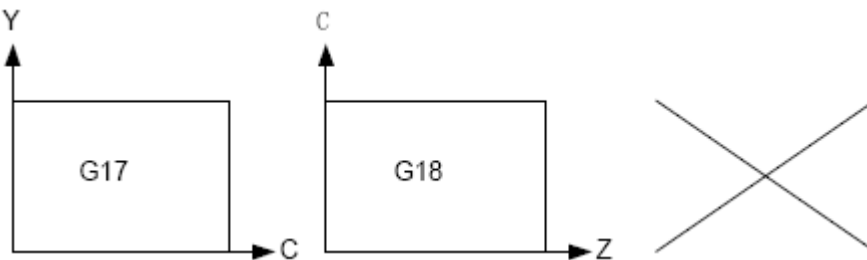

The rotary axis is set to Y or its parallel axis in the cylindrical interpolation mode:

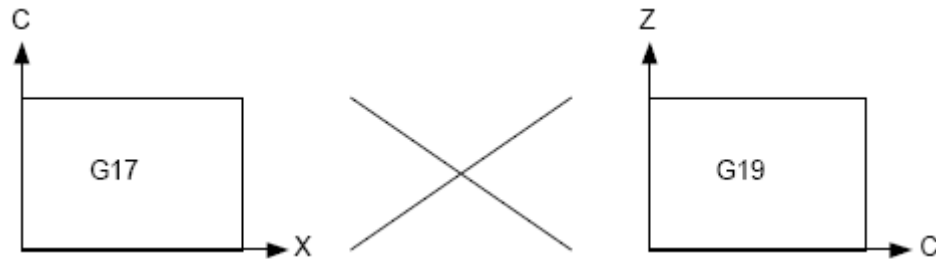

The rotary axis is set to Z or its parallel axis in the cylindrical interpolation mode:



#### Relative parameters:

Only rotary axis is specified in the cylindrical interpolation, and it can be a basic axis or an axis parallel to the basic axis. The axis name of three additional axes are set by NO.225, NO.226, NO.227 (Y: 89, A: 65, B: 66, C: 67), the attribute of an axis is set by NO.230, NO.231, NO.232(see the following table).

Setting value	Meaning
0	It is not three basic axes and their parallel axis
1	X of three basic axes
2	Y of three basic axes
3	Z of three basic axes
5	An axis parallel to X axis
6	An axis parallel to Y axis
7	An axis parallel to Z axis

#### Example:

No. 224 is set to 5, the cylindrical interpolation is executed in G18 plane, the rotary axis of the cylindrical interpolation is set to the 5<sup>th</sup> axis(state parameter P187). The axis name of the 5<sup>th</sup> is C(data parameter No. 225), the axis is an one parallel to X axis (NO.230). The radius of the cylinder is 57.299mm, and the developed cylindrical surface is shown below:

O0071 (taking example of the cylindrical interpolation G7.1)

```
G18;
G98;
G00 X150 Z105 C0;
G01 X114.598 Z105 F200;
G07.1 C57.299;
G41 G01 Z120;
N10 G01 C30.0;
N20 G03 Z90 C60 R30;
N30 G01 Z70;
N40 G02 Z60 C70 R10;
N50 G01 C150;
N60 G02 Z70 C190 R75;
N70 G01 Z110 C230;
N80 G03 Z120 C270 R75;
N90 G01 C360;
G40 G01 Z105;
G07.1 C0;
M30;
```

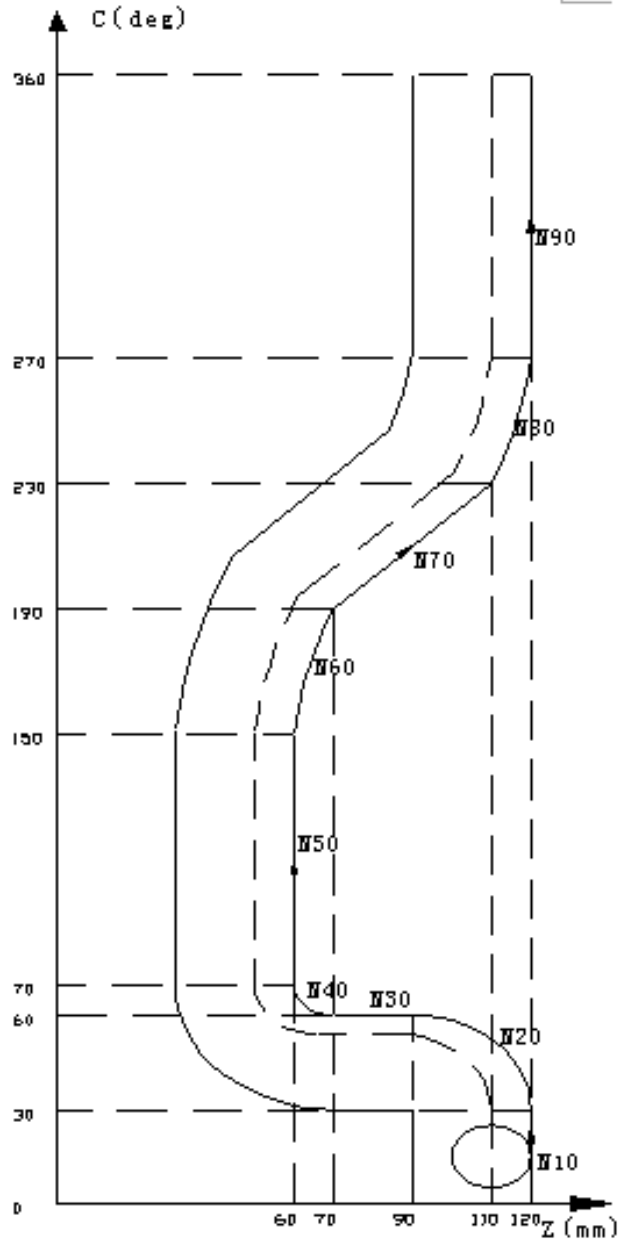

### 3.11 Chamfering Function

Chamfering function is to insert one straight line or circular between two contours to make the tool smoothly transmit from one contour to another one. GSK980TDc uses the linear and circular chamfering functions.

#### 3.11.1 Linear chamfering

Linear chamfering: insert one straight line in the linear contours, arc contours, linear contour and arc contour. The command address of linear chamfering is L, behind which data is the length of chamfering straight line. The linear chamfering must be used in G01, G02 or G03 command.

##### A. Linear to linear

**Command format:** G01 X(U)\_ Z(W)\_ L\_;

G01 X(U)\_ Z(W)\_;

**Command format:** G01 X(U)\_ Z(W)\_ L\_;

**Command function:** insert one straight line between two linear interpolation blocks.

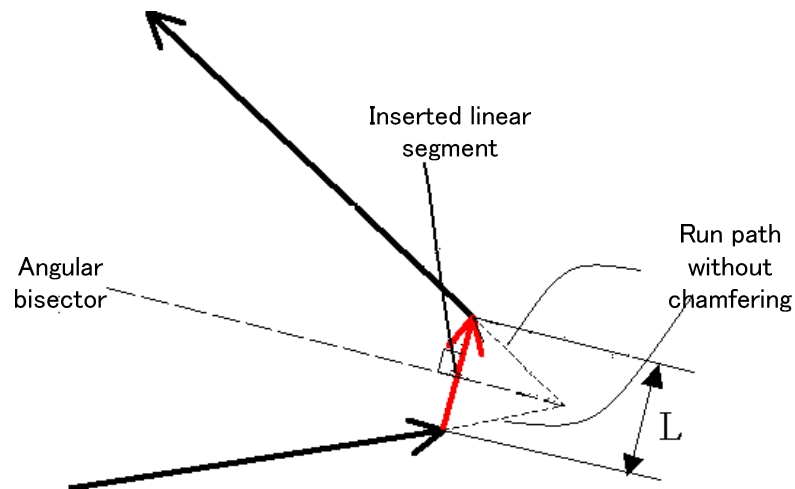

### B. Linear to circular

**Command format:** G01 X(U)\_ Z(W)\_ L\_;  
G02/G03 X(U)\_ Z(W)\_ R\_;

Or

G01 X(U)\_ Z(W)\_ L\_;  
G02/G03 X(U)\_ Z(W)\_ I\_ K\_;

**Command function:** insert one straight line between the linear and circular interpolation blocks.

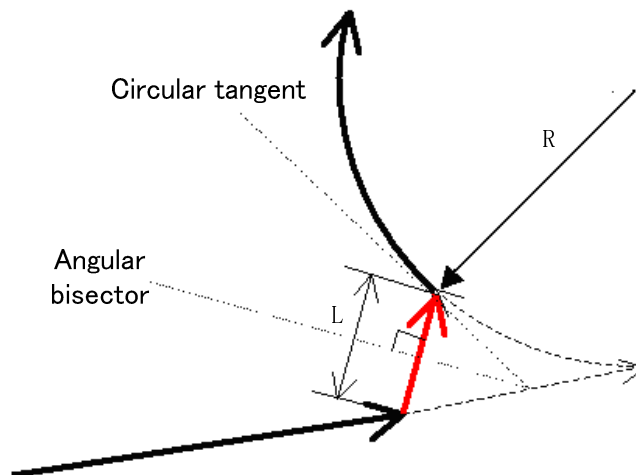

### C. Circular to circular

**Command format:** G02/G03 X(U)\_ Z(W)\_ R\_ L\_;  
G02/G03 X(U)\_ Z(W)\_ R\_;

Or

G02/G03 X(U)\_ Z(W)\_ I\_ K\_ L\_;  
G02/G03 X(U)\_ Z(W)\_ I\_ K\_;

**Command function:** insert one straight line between two circular interpolation blocks.

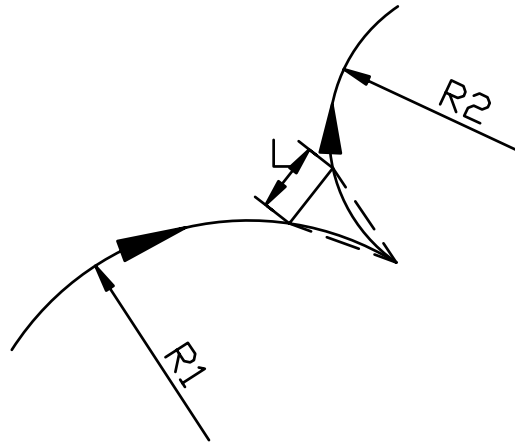

**D. Circular to linear**

```

Command format: G02/G03 X(U)_ Z(W)_ R_ L_;
                G01 X(U)_ Z(W)_;
Or
                G02/G03 X(U)_ Z(W)_ I_ K_ L_;
                G01 X(U)_ Z(W)_;
    
```

**Command function:** insert one straight line block between circular and linear interpolation block.

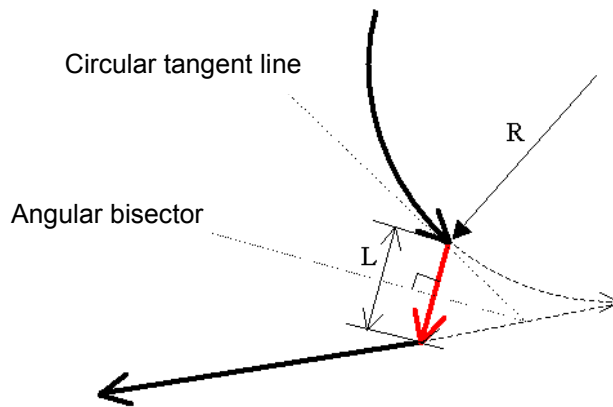

**3.11.2 Circular chamfering**

Circular chamfering: insert one circular between linear contours, circular contours, linear contour and circular contour, the circular and the contour line are transited by the tangent. The command of circular chamfering is D, and the data behind the command is the radius of chamfering circular. The circular chamfering must be used in G01, G02 or G03.

**A. Linear to linear**

```

Command format: G01 X(U)_ Z(W)_ D_;
                G01 X(U)_ Z(W)_;
    
```

**Command function:** insert one circular between two straight lines, the inserted circular block and two straight lines are tangent, the radius is the data behind the command address D.

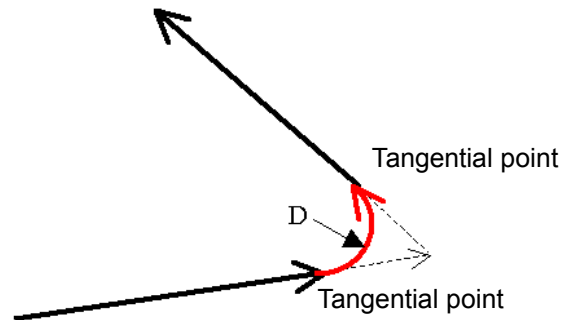

**B. Linear to circular**

**Command format:** G01 X(U)\_ Z(W)\_ D\_;  
 G02/G03 X(U)\_ Z(W)\_ R\_;  
 or  
 G01 X(U)\_ Z(W)\_ D\_;  
 G02/G03 X(U)\_ Z(W)\_ I\_ K\_;

**Command function:** insert one circular between linear and circular, the inserted circular is tangent to the linear and the circular, and the radius is the data behind the command address D.

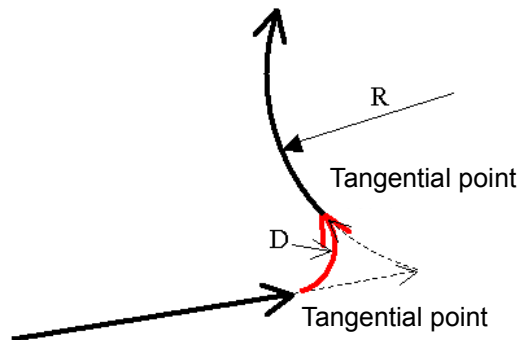
**C. Circular to circular**

**Command format:** G02/G03 X(U)\_ Z(W)\_ R\_ D\_;  
 G02/G03 X(U)\_ Z(W)\_ R\_;  
 or  
 G02/G03 X(U)\_ Z(W)\_ R\_ D\_;  
 G02/G03 X(U)\_ Z(W)\_ I\_ K\_;  
 or  
 G02/G03 X(U)\_ Z(W)\_ I\_ K\_ D\_;  
 G02/G03 X(U)\_ Z(W)\_ I\_ K\_;  
 or  
 G02/G03 X(U)\_ Z(W)\_ I\_ K\_ D\_;  
 G02/G03 X(U)\_ Z(W)\_ R\_;

**Command function:** insert one circular between two circular blocks, the inserted circular is tangent to the two circular blocks, and the radius is the data behind the command address D.

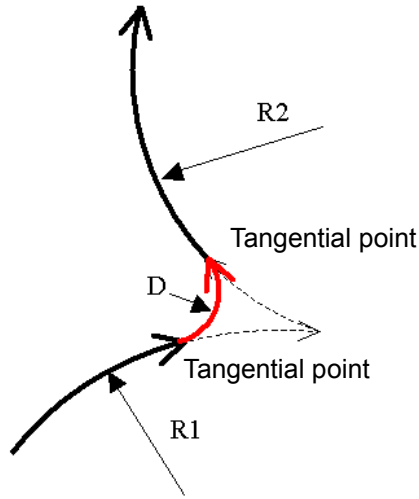

**D. Circular to linear**

**Command format:** G02/G03 X(U)\_ Z(W)\_ R\_ D\_;

G01 X(U)\_ Z(W)\_;

Or

G02/G03 X(U)\_ Z(W)\_ I\_ K\_ D\_;

G01 X(U)\_ Z(W)\_;

**Command function:** insert one circular block between the circular and the linear, the inserted circular block is tangent to the circular and the linear, and the radius is the data behind the command address D.

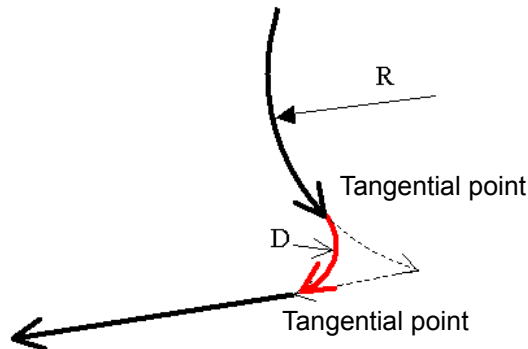

**3.11.3 Special cases**

The chamfering function is invalid or alarms as follows:

**1) Linear chamfering**

A. The chamfering function is invalid when two interpolation straight lines are in the same linear.



B. CNC alarms when the chamfering linear is too long.

L1 is the chamfering linear, and the length is L<sub>1</sub>; l<sub>2</sub> is the third edge of the triangle which is formed by two interpolation straight lines, the length is L<sub>2</sub>, CNC alarms when L<sub>1</sub> is bigger than L<sub>2</sub> as follows:

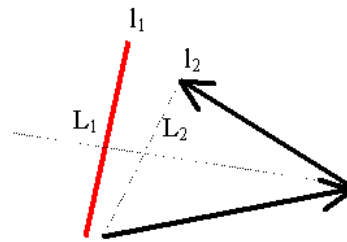

C. Some linear block is too short

The chamfering linear length is  $L$ , CNC alarms when other end of the calculated chamfering linear is not in the interpolation linear (in the extension line of the interpolation linear).

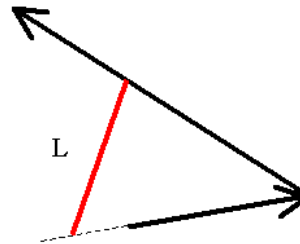

## 2) Circular chamfering

A. The circular chamfering function is invalid when two interpolation straight lines are in the same block.



B. CNC alarms when the chamfering circular radius is too big.

CNC alarms when the chamfering circular radius is  $D$ , max. circular radius of the tangential linear lines is  $R_{max}$  which is less than  $D$  as follows.

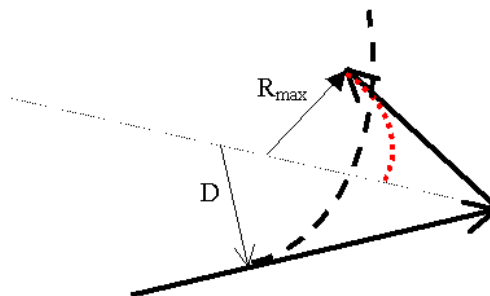

C. The circular chamfering function is invalid when the linear and the circular, or the circular and the linear are tangential.



D. The circular chamfering function is invalid when one circular and another one are tangential.



The circular chamfering function is valid when the circular tangency is as follows:

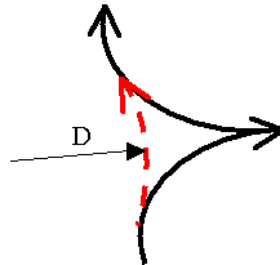

### 3.12 Dwell G04

**Command format:** G04 P\_\_ ; or  
 G04 X\_\_ ; or  
 G04 U\_\_ ; or  
 G04 ;

**Command function:** each axis stops the motion, the modal of G commands and the reserved data, state are not changed, and execute the next block after dwelling the defined time.

**Command specification:** G04 is non-modal.

G04 dwell time is defined by the word P\_\_, X\_\_ or U\_\_.

Range of -99999999~99999999 (unit: ms) .

X, U range is -99999999~99999999 x least input unit (unit: s)

**Notes:**

- The exact stop is executed between the blocks when P, X, U are not input.
- The system exactly stop a block when P, X, U are not input or P, X, U specify negative values.
- P is valid when P, X, U are in the same block; X is valid when X, U are in the same block.
- When the system executes the feed hold in G04, dwell can be executed after the current delay time.

### 3.13 Machine Zero Function

#### 3.13.1 Machine 1st reference point G28

**Command format:** G28 X(U) \_\_ Z(W) \_ ;

**Command function:** the tool rapid traverses to the middle point defined by X(U), Z(W) from starting point and then return to the machine zero.

**Command specifications:**

G28 is non-modal.

X, Z, Y: absolute coordinates of middle point;

U, W, V: Z absolute coordinates of middle point;

W: Difference value of absolute coordinates between middle point and starting point in Z direction.

Omit all or one of X(U), Z(W) as follows:

Table 3-4

Command	Function
G28 X(U) __	X returns to machine zero and Z axis remains in the previous position
G28 Z(W) __	Z returns to machine zero and X axis remains in the previous position
G28	in the previous positions and continuously execute the next block
G28 X(U) __ Z(W) __	X, Z return to machine zero simultaneously

Running path(as Fig. 3-12) :

- (1) Rapid traverse to middle point of specified axis from current position(A point→B point) ;
- (2) Rapid traverse to reference point from the middle point(B point→R point) ;
- (3) If the machine is not locked, LED is ON when the machine reference point return is completed.

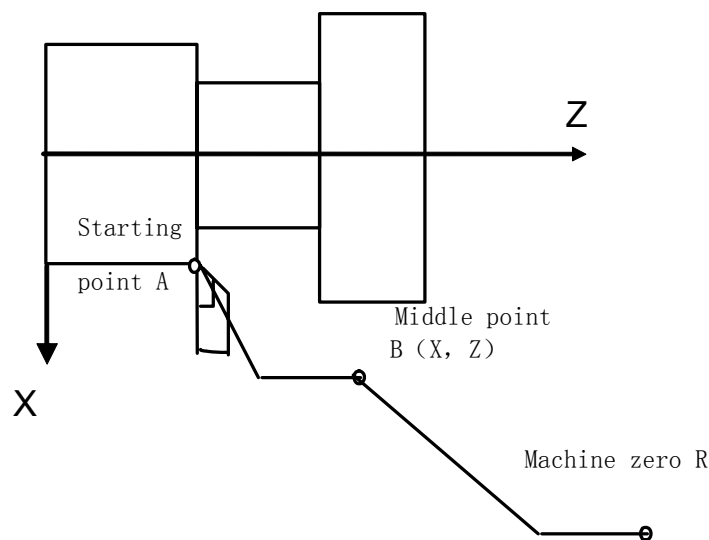

Fig.3-12

- Note 1:** Do not execute G28 and machine zero return without the zero switch on the machine.
- Note 2:** Machine zero returns in Jog mode and in G28 are the same and their deceleration signals and the signal every rotation must be detected;
- Note 3:** X and Z move at the respectively rapid traverse speed from A to B and from B to R, and so the path is not always a straight line;
- Note 4:** The system cancels the tool length compensation after executing G28 to perform the machine zero return;

### 3.13.2 Machine 2nd, 3rd, 4th reference point G30

Machine zero is fixed point in the machine tool, decided by the zero switch and zero return switch installed on the machine tool.

Machine reference point is located at the position after the machine zero offsets No.114 or No.115 value, when No.114, No.115 setting value is 0, the machine reference point coincides with the machine zero. The coordinates of machine reference point are No.120, No.121 setting value. Executing machine zero return is considered to executing the machine reference point return.

GSK980TDC has machine 2<sup>nd</sup>, 3<sup>rd</sup>, 4<sup>th</sup> reference point functions. Use separately No.122~No.127

to set X, Z machine coordinates of the machine 2<sup>nd</sup>, 3<sup>rd</sup>, 4<sup>th</sup> reference point.

The relationship between the machine zero, machine reference point, machine 2<sup>nd</sup>, 3<sup>rd</sup>, 4<sup>th</sup> reference point is as follows:

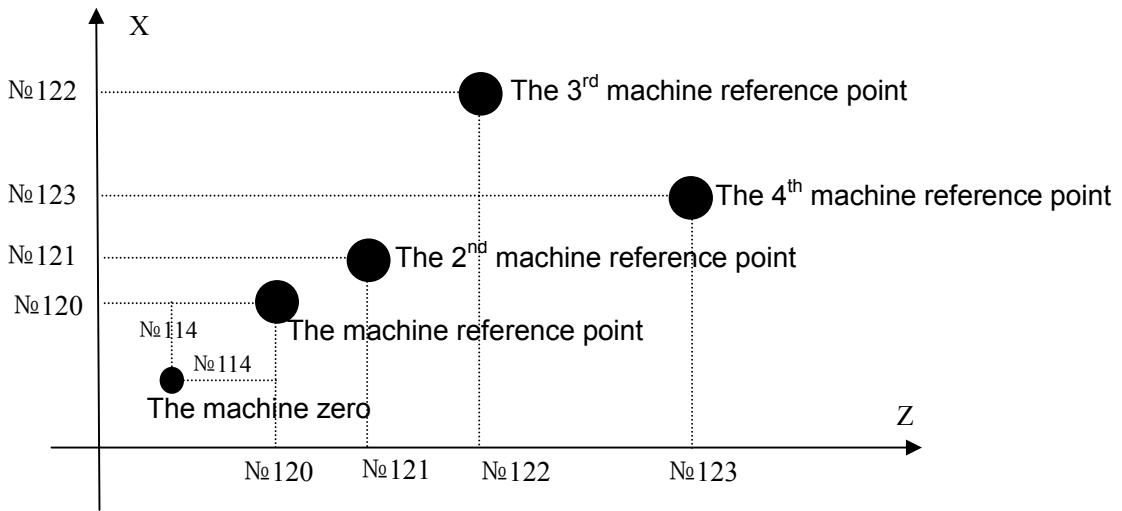

**Command format:**

```
G30 P $\underline{2}$  X(U) __ Z(W) __;
G30 P $\underline{3}$  X(U) __ Z(W) __;
G30 P $\underline{4}$  X(U) __ Z(W) __;
```

**Command function:** the tool rapidly traverses with the rapid traverse speed to the middle point specified by X(U) , Z(W)

**Command specifications:** G30 is non-modal.

- X: X absolute coordinate of the middle point;
  - U: difference value of X absolute coordinate value between the middle point and starting point;
  - Z: Z absolute coordinate of the middle point;
  - W: difference point of Z absolute coordinate between the middle point and starting point.
- Omit one or all of X(U) , Z(W) as follows:

Command	Function
G30 P $\underline{n}$ X(U) __	X returns to the machine nth reference point, Z axis retains
G30 P $\underline{n}$ Z(W) __	Z return to the nth machine reference point, X axis retains
G30	X and Z retain, go on executing the next program block
G30 P $\underline{n}$ X(U) __ Z(W) __	X and Z return to the machine nth reference point simultaneously

**Note 1:** n in the above table is 2, 3 or 4;

**Note 2:** Do not check the deceleration, zero signal when you execute the machine 2<sup>nd</sup>, 3<sup>rd</sup>, 4<sup>th</sup> reference point.

**Command operations:** (taking example of returning to machine 2<sup>nd</sup> reference point as follows):

- (1) Rapidly traverse to the middle position of command axis from the current position (A point →B point);
- (2) Traverse from the middle point with the speed set by No.113 to the 2<sup>nd</sup> reference point set by No.122 and No.123 (B point →R2 point);
- (3) When CNC is not in the machine lock state, the completion signal of reference point return ZP21 Bit0, Bit1 is high.

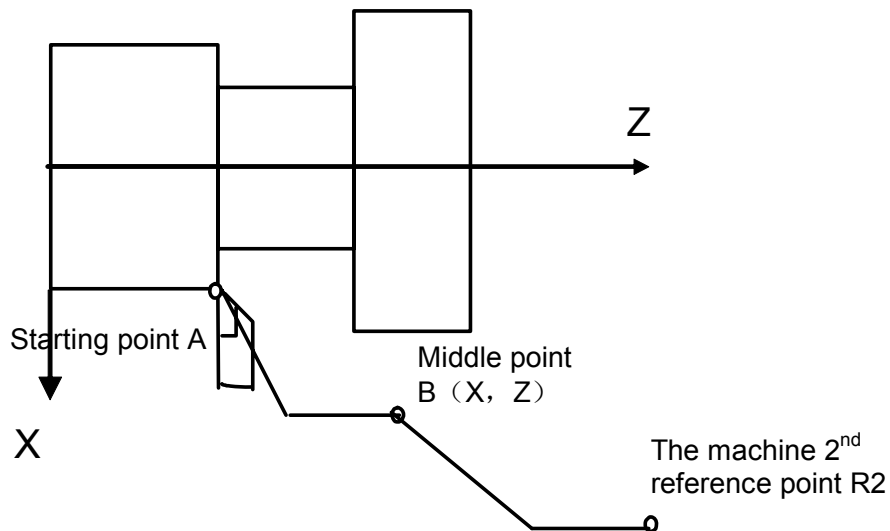

- Note 1:** Execute the machine 2<sup>nd</sup>, 3<sup>rd</sup>, 4<sup>th</sup> reference point return after you manually execute the machine reference point return or G28 (machine reference point return).
- Note 2:** A→B and B0→R2, two axes separately traverse, and so their trails are linear or not.
- Note 3:** CNC cancels the tool length compensation after you execute G30 to return 2<sup>nd</sup>, 3<sup>rd</sup>, and 4<sup>th</sup> reference point.
- Note 4:** Must not execute G30 (machine 2<sup>nd</sup>, 3<sup>rd</sup>, 4<sup>th</sup> reference point return) when the zero switch is not installed on the machine.
- Note 5:** Do not set the workpiece coordinate system when you execute the 2<sup>nd</sup>, 3<sup>rd</sup>, and the machine 4<sup>th</sup> reference point return.

### 3.14 Skip Interpolation G31

**Command format:** G31 X(U)\_ Z(W)\_ F\_;

**Command function:** in executing the command, when the outside skip signal (X3.5) is input, the system stops the command to execute the next block. The function is used to the dynamic measure (such as milling machine), toolsetting measure and so on of workpiece measure.

**Command explanations:** non-modal G command (00 group);

Its address format is same that of G01;

Cancel the tool nose radius compensation before using it;

Feedrate should not be set to too big to get the precise stop position;

a. following block execution after skip:

1. The next block of G31 is the incremental coordinate programming shown in Fig. 3-13:

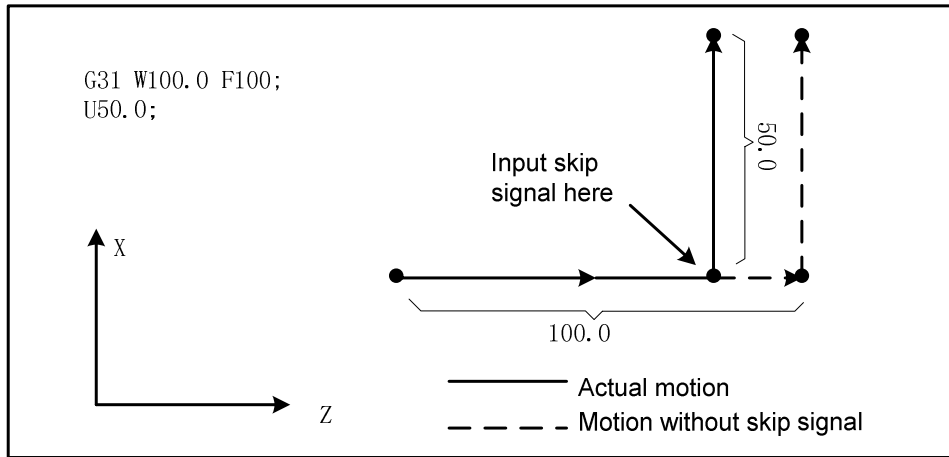

Fig. 3-13

2. The next block of G31 is the absolute coordinate programming of one axis as Fig. 3-14:

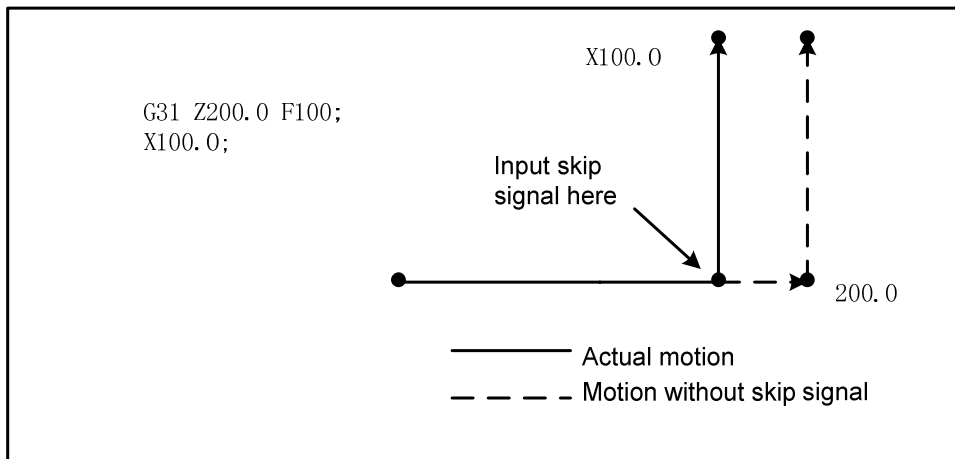

Fig. 3-14

3. The next block of G31 is the absolute coordinate programming of two axes shown in Fig. 3-15:

Program: G31 Z200 F100  
G01 X100 Z300

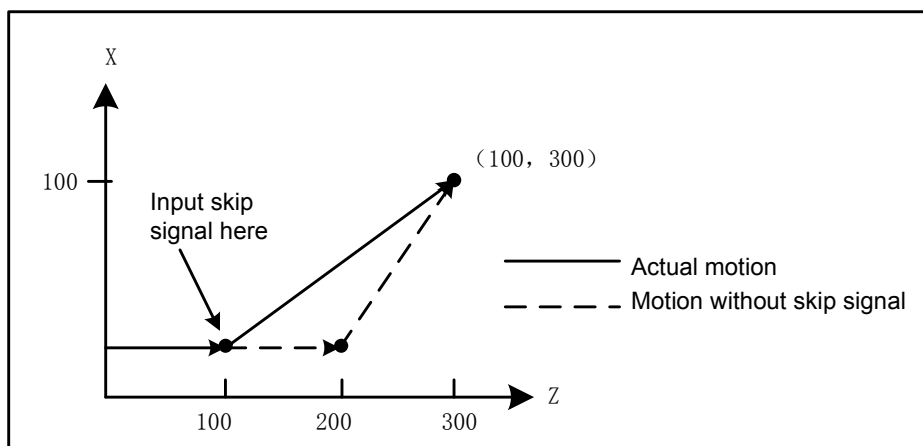

Fig. 3-15



## b. Signals relevant to G31

Skip signal:

SKIP: X3.5

Type: input signal

Function: X3.5 ends the skip cutting. I.e. in a block containing G31, the skip signal becoming the absolute coordinate position of “1” is to be stored in the macro variable (#997~#999 separately corresponds to X, Z, Y)

Operation: when the skip signal becomes “0”, CNC executes as follows:

When the block is executing G31, CNC stores the current absolute coordinates of each axis. CNC stops G31 to execute the next block, the skip signal detects its state instead of its RISING EDGE. So when the skip signal is “1”, it meets the skip conditions.

**Note:** If G31 is not used, X3.5 input interface is used to the common input interface. The skip signal is valid, CNC immediately stops the feed axis (without acceleration/deceleration execution), and G31 feedrate should be as low as possible below 1000 mm/min to get the precise stop position.

c. Parameters relevant to G31: refer to III INSTALLATION & CONNECTION, Section 3.2.15.

### 3.15 Automatic Tool Offset G36, G37

**Command format:** G36 X\_\_;  
G37 Z\_\_;

**Command function:** when the command is executed to make the tool move to the measured position, the CNC automatically measures the difference between the current actual coordinates and the command coordinates to be the tool offset value. The function is used to the automatic toolsetting.

**Explanations:** X absolute coordinate(only used to G36), Z absolute coordinate (only used to G37);  
Non-modal G command (00 group);  
Cancel the tool nose radius compensation before using it;  
Only use the absolute programming;  
Define the workpiece coordinate system before using the command;  
Specify the tool number and tool compensation number before using the command;

#### a. Signals relevant to G36, G37 automatic tool offset:

Measured position arrival signal:

XAE(X3.6) ————corresponding to G36

ZAE(X3.7) ————corresponding to G37

Type: input signal

**Function:** when the position measured by the program command is different from that where the tool actually reaches (i.e. at the time, the measured position arrival signal becomes “1”), the difference of the coordinates is added to the current tool compensation value to update the compensation value. When G36X\_(or G37Z\_) is executed, the tool firstly rapidly traverses to the position measured by the command, and decelerates and temporarily stop the position before the measured position, and then, reaches to the measured position at the speed set by No.141. When the measured position arrival signal corresponding to G command becomes “1”, and the tool is in the measured position range  $\pm\epsilon$ , CNC updates the offset compensation value and ends the block.

When the measured position arrival signal does not become “1”, and after the tool reaches the measured position distance  $\epsilon$ , the CNC alarms, ends the block and does not update the offset compensation value.

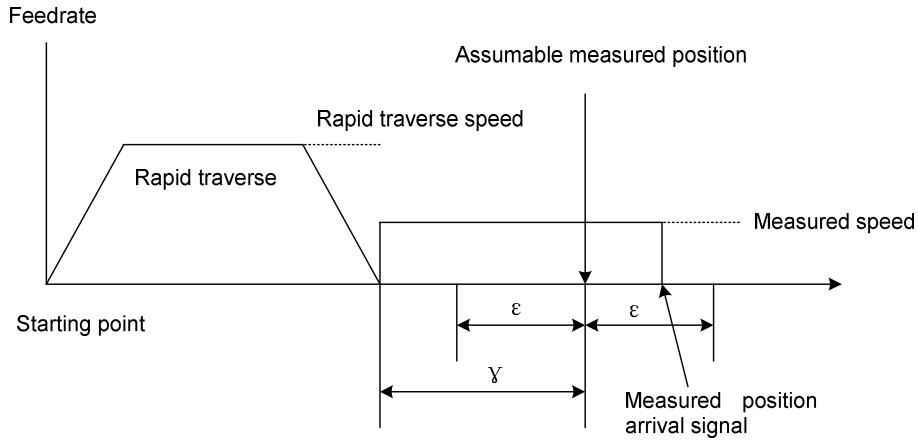

**b. Parameters relevant to G36, G37: refer to INSTALLATION, Section 3.2.16.**

**c. G36, G37 automatic tool offset command use**

Feedrate and alarm

From the initial position to the measured position specified by Xa or Za in G36 or G37, the tool rapidly traverses to A zone and stops at T point ( $X_a - \gamma_x$  or  $Z_a - \gamma_z$ ), and then traverses to B, C and D at the feedrate set by No.141. The system alarms when the tool traverses in B zone and the measured point arrival signal of the end point is set to. CNC alarms when the tool stops at V point.

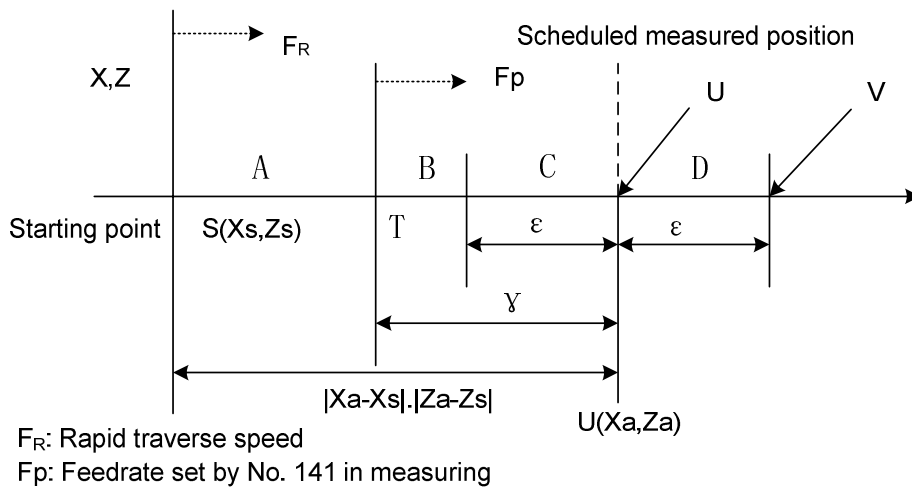

Example:

- G50 X760 Z1100; create the workpiece coordinate system
- T0101; define No. 1 tool and execute its tool compensation
- G36 X200; traverse to X toolsetting point ( X toolsetting point coordinate: 200)
- T0101; execute X tool compensation again
- G00 X204; retract a little
- G37 Z800; traverse to Z toolsetting point ( Z toolsetting point coordinate: 800)
- T0101; execute Z tool compensation again and the toolsetting is completed

M30;

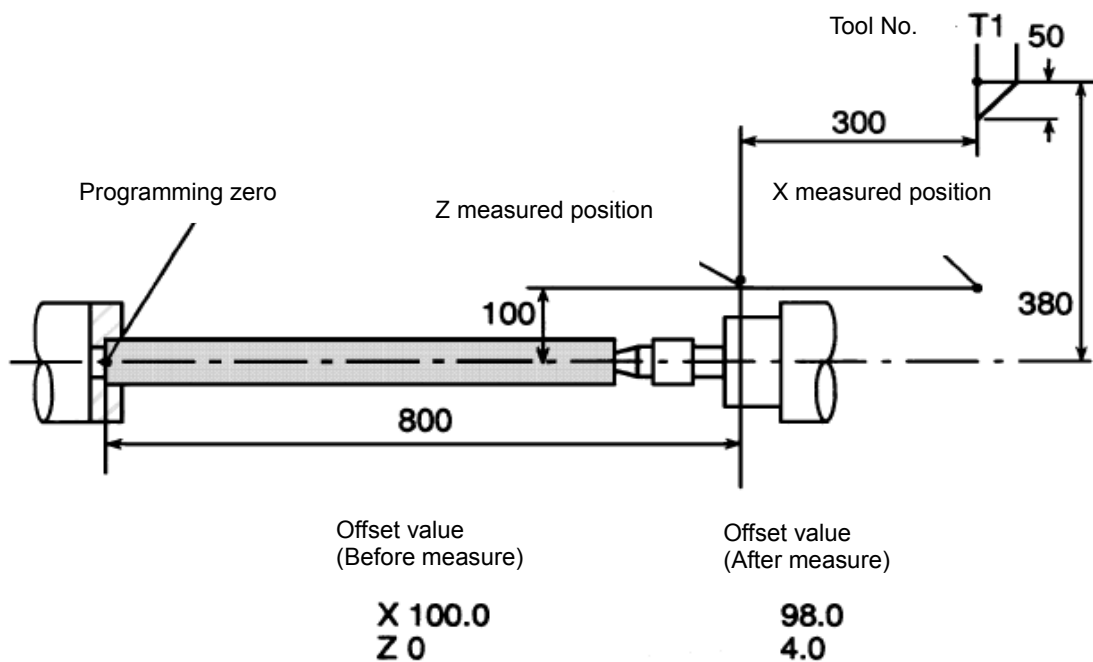

### 3.16 Workpiece Coordinate System G50

**Command format:** G50 X(U) \_\_\_ Z(W) \_\_\_;

**Command function:** define the absolute coordinates of current position and create the workpiece coordinates system (called floating coordinates system) by setting the absolute coordinates of current position in the system. After G50 is executed, the system takes the current position as the program zero (program reference point), and the system returns to the point after executing the program zero return. After the workpiece coordinate system is created, input the coordinate values with the coordinate system in the absolute coordinates programming until the next workpiece coordinate system is created again (using G50).

**Command specifications:**

G50 is non-modal;

X: New absolute coordinates of current position in X direction;

U: Different value between the new absolute coordinates of current position in X direction and the absolute coordinates before executing commands;

Z: New absolute coordinates of current position in Z direction;

W: Different value between the new absolute coordinates of current position in X direction and the absolute coordinates before executing commands;

In G50, when X(U) or Z(W) are not input, the system does not change current coordinates position as program zero; when X(U) and Z(W) are not input, the system takes the previous setting position as program zero.

Example:

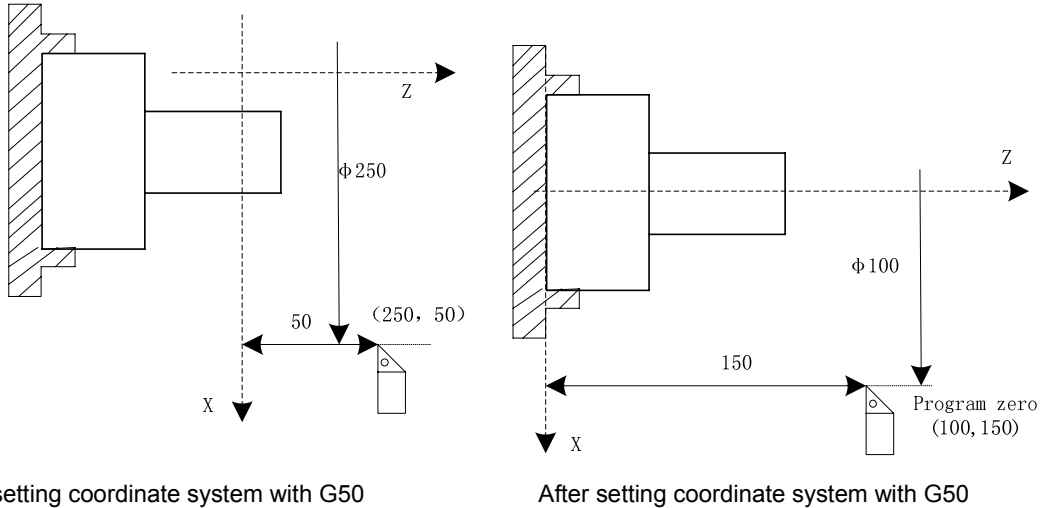

Fig.3-16

As Fig.3-16, create the above-mentioned workpiece coordinate system and set (X100 Z150) to the reference point of program after executing “G50 X100 Z150”.

**Note:** When No.003 Bit4 is 1(executing tool compensation by coordinates offset), T function is executed, motion command is not executed and the system creates workpiece coordinate system with G50, the displayed coordinate value are ones which are defined by G50 adding or subtracting tool compensation value which is not executed.

Current tool compensation state	Executing motion command	Coordinate value after executing G50 X20 Z20	No. 01 tool compensation value
T0100 or T0101	G0 X_ Z	X: 20 Z: 20	X: 12 Z: 23
	Motion command not executed	Coordinate value after executing G50 X20 Z20	
	※※※	X: 8 Z: -3 or X: 32 Z: 43	

### 3.17 Local Coordinate System

When the programming is executed in a workpiece coordinate system, a sub workpiece coordinate can be created in the workpiece coordinate system, which is called as a local coordinate system.

**Command format:** G52 X(U)\_ Z(W)\_

**Command function:** when G52 is executed, all workpiece coordinate system can (G54~G59) set a local coordinate system. Origin of each local coordinate system is the specified position X(U)\_ Z(W)\_ of each workpiece coordinate system. Corresponding relation of workpiece coordinate systems is shown below:

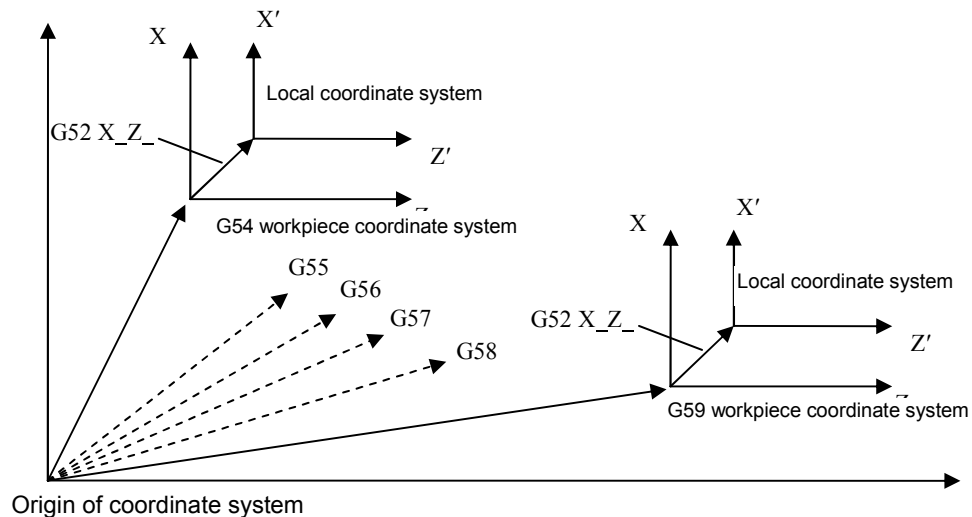

**Explanation:** G52 is in Group 00, and is simple.  $X(U)\_ Z(W)\_$  is the position of origin of the specified local coordinate system in the current workpiece coordinate system. Results in absolute or incremental execution are the same.

**Notes:**

- Setting of local coordinate system does not change a workpiece coordinate system and a machine coordinate system.
- Temporarily cancel tool nose radius compensation when G52 is executed.
- After G52 is specified, the local coordinate system does not remain valid until the next G52 is specified. G52 does not perform movement when it is specified.
- When a local coordinate system is cancelled, its zero and that of workpiece coordinate system are consistent, i.e., command G52 X0 Z0 or G52 U0 W0.
- When G50 sets a workpiece coordinate system, local coordinate systems of all workpiece coordinate systems which axes are specified are cancelled. The local coordinate systems which coordinate axes are not specified are not cancelled when not all axes' coordinate value are specified.
- Whether the local coordinate system is cancelled is determined by a parameter when reset, machine zero return or end of program.

**Example:**

```

N1 G28 X0 Z0;
N2 G55 G00 X50 Z50;
N3 G52 X100 Z100;
N4 G00 X50 Z50;
N5 G01 Z100 F100;
N6 X100;
N7 G52 X0 Z0;
N8 G00 X0 Z0;
N9 M30;
    
```

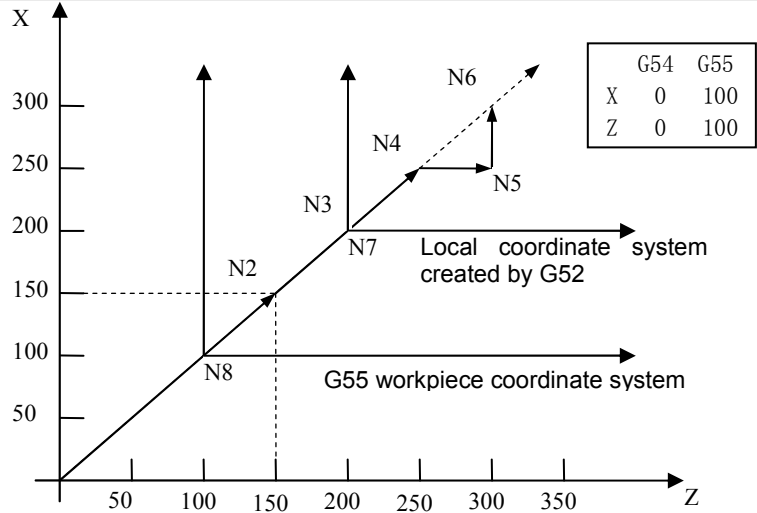

In N3 block, a local coordinate system is created according to G55 workpiece coordinate system, and it is cancelled in the block N7.

### 3.18 Workpiece Coordinate System G54~G59

**Command format:** G54 workpiece coordinate system 1

- G55 workpiece coordinate system 2
- G56 workpiece coordinate system 3
- G57 workpiece coordinate system 4
- G58 workpiece coordinate system 5
- G59 workpiece coordinate system 6

**Command function:** one of G54~G59 is specified, one of workpiece coordinate system 1~6 is selected. After a workpiece coordinate system is specified, the specified point is in the specified workpiece coordinate system till a new workpiece coordinate system is set.

**Explanation:** G54~G59 are modal.

In the system, each coordinate system should correspond to ZOFS1~ ZOFS6 of zero offset value of one workpiece coordinate system, relation between ZOFS1~ ZOFS6 and previous workpiece is shown below:

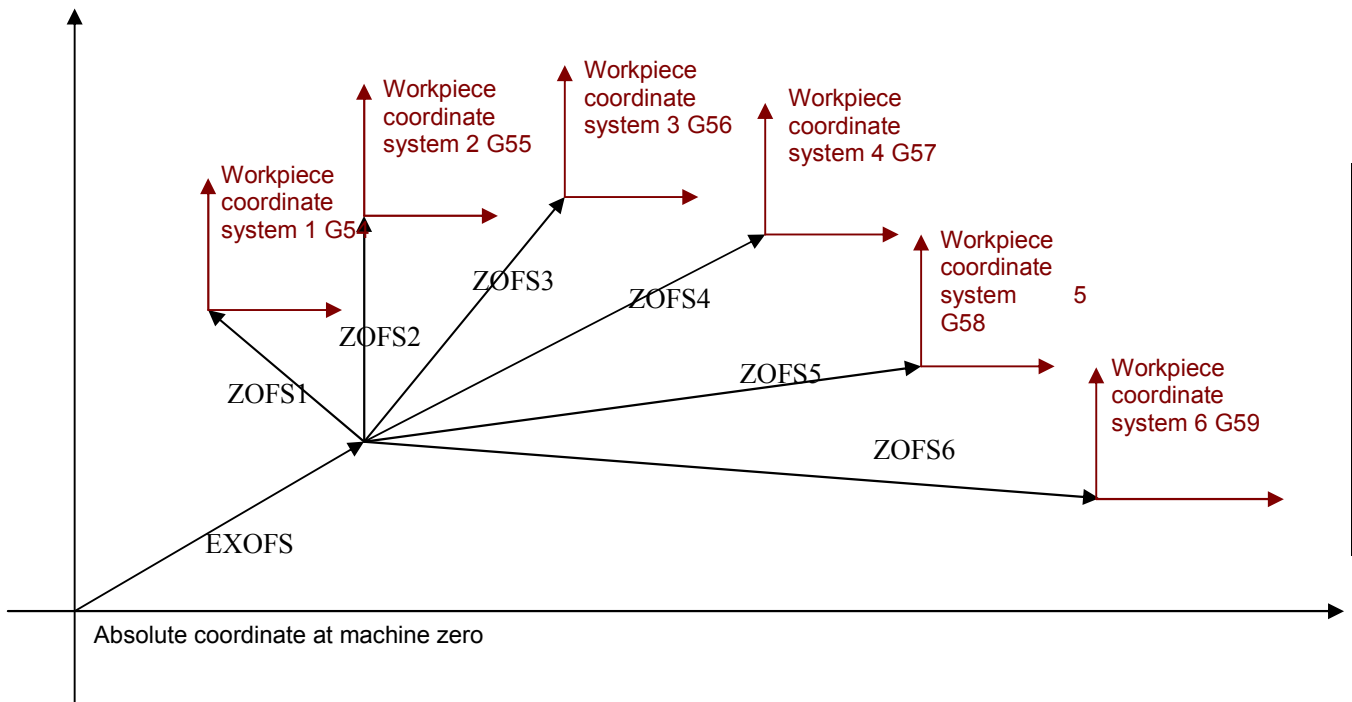

EXOFS: external workpiece coordinate zero (it is added to zero offset value of each workpiece coordinate system, its value is a part of tool compensation->setting in the workpiece coordinate system)

ZOFSn: zero offset value of each workpiece coordinate system ZOFS1~ZOFS6 (its value is a part of tool compensation->setting in the workpiece coordinate system)

When №11.7 (APRS) is set to 1, an absolute coordinate system is set after machine zero return, and then EXOFS and ZOFSn setting values are offset. Current workpiece coordinate setting after zero return is shown: new workpiece coordinates=current absolute coordinates- (ZOFSn + EXOFS).

### G54~G59 workpiece coordinate system switch

Specifying G54~G59 can switch 6 workpiece coordinate systems to make the system work in different workpiece systems. Absolute coordinate variation of current position is the origin offset value between the new workpiece coordinate system and the old. Namely: new absolute coordinates =current absolute coordinates - (ZOFS new – ZOFS old)

#### Example:

Example 1:

Absolute coordinates after zero return is (0,0); EXOF=(0,0) ; ZOFS1=(-10,-10);

Absolute coordinate values after zero return in G54:  $0 - (-10 + 0) = 10$ ;

Example 2:

Absolute coordinate values after zero return: (20,20); EXOF=(5,5) ; ZOFS2=(10, 10);

Absolute coordinate values after zero return in G55:  $20 - (10 + 5) = 5$ ;

Example 3:

Current absolute coordinates (10,10); EXOF=(5,5) ; ZOFS1=(-10,-10); ZOFS2 = (-30,-30); absolute coordinate values from G54 to G55:  $10 - (-30 - (-10)) = 30$

Notes:

- When №11.7 (APRS) is set to 0, the absolute coordinate system after machine zero return is not set, and the EXOF and ZOFSn offset cannot be executed because the workpiece coordinate system is not set again.
- Modification setting of EXOFS and ZOFSn are valid only in non-run state, namely, setting values of each workpiece coordinate system cannot be modified when a program is running.
- The workpiece coordinate system offset is immediately valid after values of EXOFS and ZOFSn are modified.
- Whether the incremental coordinates include offset values of the coordinate system is set by №05.1 (PPD) .
- In tool nose radius compensation mode, compensation is cancelled temporarily in G54~G59, and is recovered in the next movement command.
- When G54~G59 and G50 are in the same block, G54~G59 are invalid, but G50 is valid.
- When G50 sets the coordinate system, origin of the current workpiece system is modified. So, there is an offset value of origins between a new coordinate system set by G50 and previously current coordinate system. The offset value should be added to offset values of origins of all workpiece coordinate systems, i.e. all workpiece coordinate systems move the same values, which are shown below:

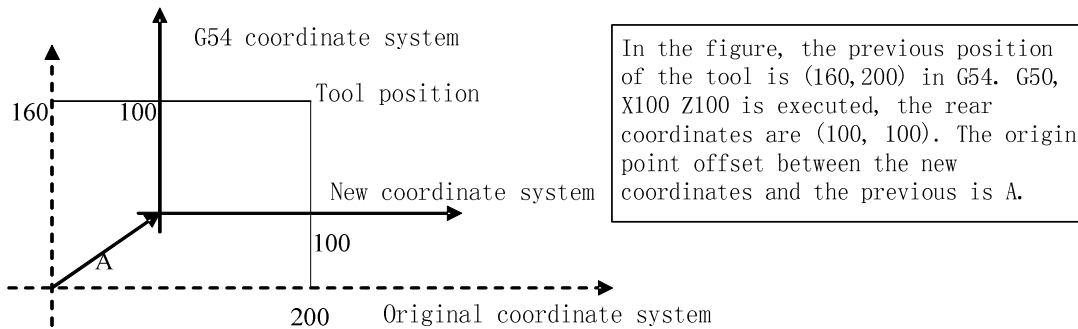

Offset value A are all workpiece coordinate systems, which are shown below:

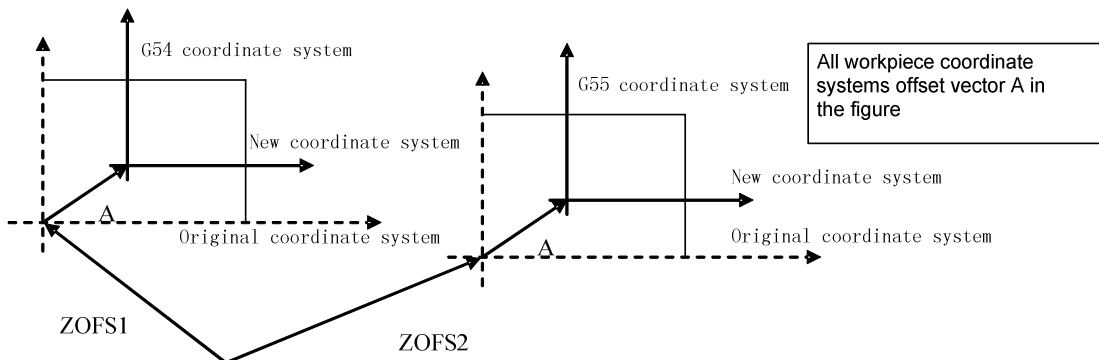



### 3.19 Fixed Cycle Command

To simplify programming, the system defines G command of single machining cycle with one block to complete the rapid traverse to position, linear/thread cutting and rapid traverse to return to the starting point:

- G90: axial cutting cycle;
- G92: thread cutting cycle;
- G94: radial cutting cycle;
- G92 will be introduced in section Thread Function.

#### 3.19.1 Axial cutting cycle G90

**Command format:** G90 X(U) \_\_ Z(W) \_\_ F\_\_ ; (cylinder cutting)  
G90 X(U) \_\_ Z(W) \_\_ R\_\_ F\_\_ ; (taper cutting)

**Command function:** From starting point, the cutting cycle of cylindrical surface or taper surface is completed by radial feeding(X) and axial (Z or X and Z) cutting.

**Command specifications:**

G90 is modal;

Starting point of cutting: starting position of linear interpolation(cutting feed)

End point of cutting: end position of linear interpolation(cutting feed)

X: X absolute coordinates of cutting end point

U: different value of X absolute coordinate between end point and starting point of cutting

Z: different value of Z absolute coordinate between end point and starting point of cutting

W: different value of Z absolute coordinate between end point and starting point of cutting

R: different value (radius value) of X absolute coordinates between end point and start point of cutting. When the signs of R is not the same that of U,  $R \leq |U/2|$ ; when R=0 or the input is default, the cylinder cutting is executed as Fig.3-17, otherwise, the cone cutting is executed as Fig. 3-18; unit: mm.

Ranges of X, U, Z, W, R are referred to Table 1-2 of Section 1.4.1, unit: mm/inch.

**Cycle process:**

- ① X rapidly traverses from starting point to cutting starting point;
- ② Cutting feed (linear interpolation) from the cutting starting point to cutting end point;
- ③ X executes the tool retraction at feedrate (opposite direction to the above-mentioned ①), and return to the position which the absolute coordinates and the starting point are the same;
- ④ Z rapidly traverses to return to the starting point and the cycle is completed.

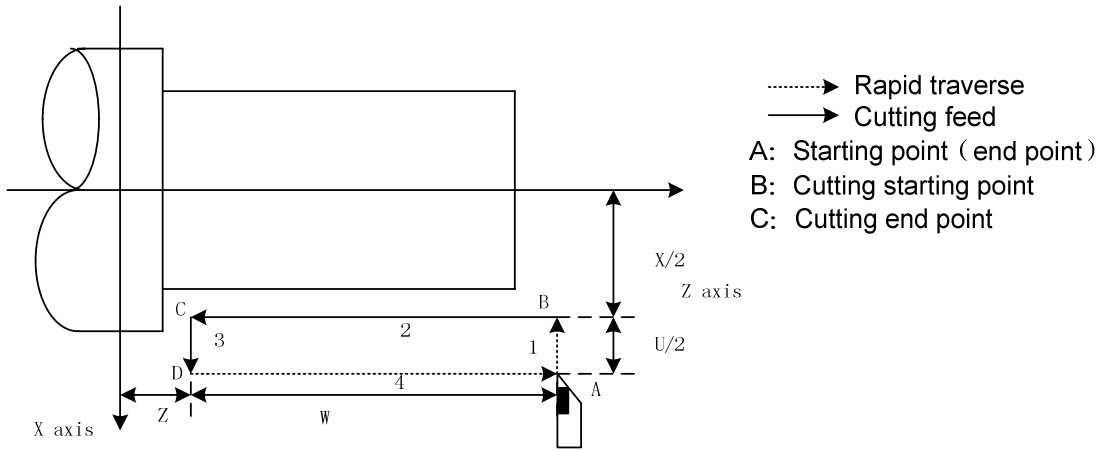

Fig. 3-17

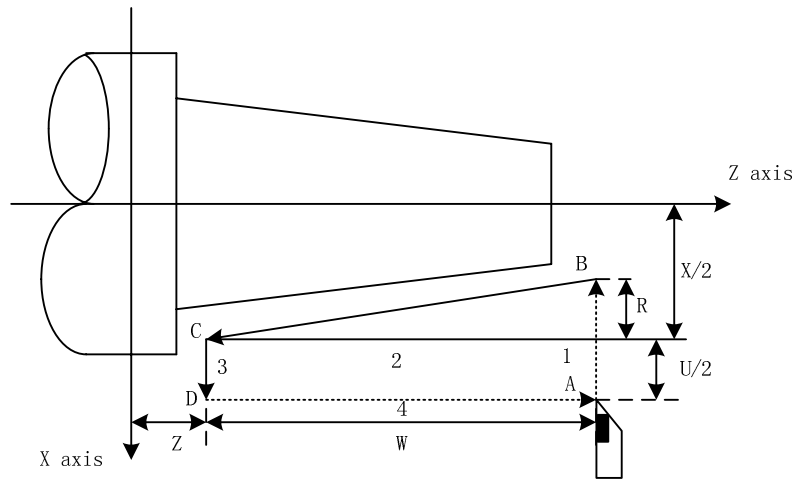
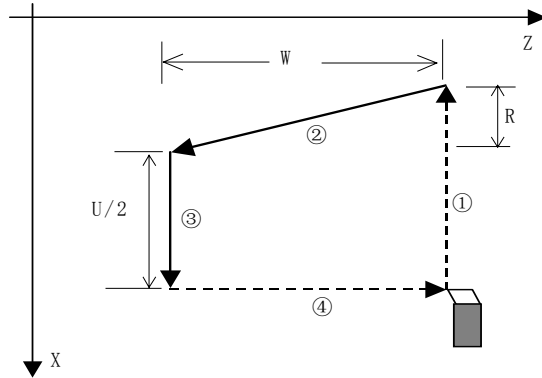
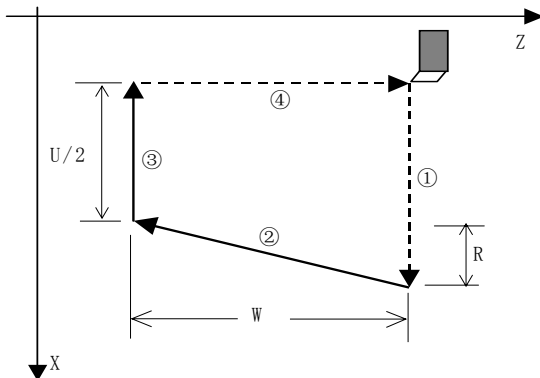

Fig. 3-18

Cutting path: Relative position between cutting end point and starting point with U, W, R, and tool path of U, W, R with different signs are shown in Fig. 3-19:

1)  $U > 0, W < 0, R > 0$

2)  $U < 0, W < 0, R < 0$



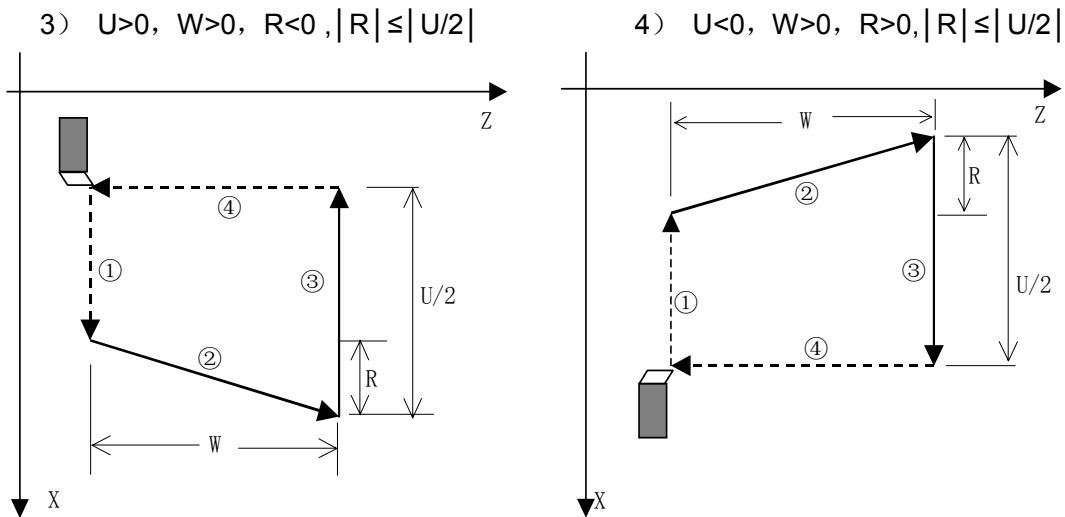

Fig. 3-19

Example: Fig. 3-20, rod  $\Phi 125 \times 110$

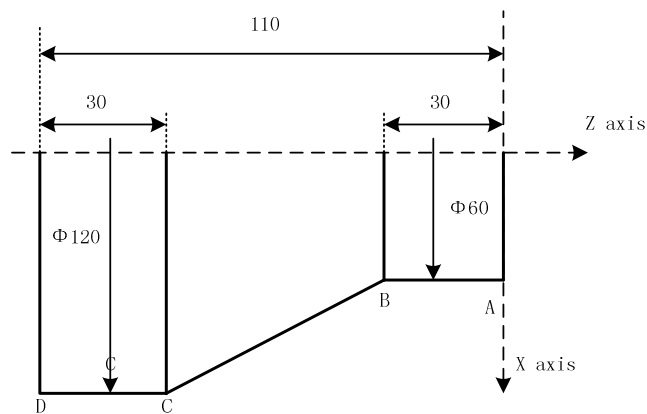

Fig. 3-20

```

Program : O0002;
M3 S300 G0 X130 Z3;
G90 X120 Z-110 F200;      (A→D, cut  $\Phi 120$ )
X110 Z-30;
X100;
X90;
X80;
X70;
X60;
G0 X120 Z-30;
G90 X120 Z-44 R-7.5 F150;
Z-56 R-15
Z-68 R-22.5
Z-80 R-30
M30;
    
```

} (A→B, 6 times cutting cycle  $\Phi 60$ , increment of 10mm)

} (B→C, 4 times taper cutting)

### 3.19.2 Radial cutting cycle G94

**Command format:** G94 X(U) \_\_ Z(W) \_\_ F\_\_ ; (face cutting)  
 G94 X(U) \_\_ Z(W) \_\_ R\_\_ F\_\_ ; (taper face cutting)

**Command function:** From starting point, the cutting cycle of cylindrical surface or taper surface is completed by radial feeding(X) and axial (Z or X and Z) cutting.

**Command specifications:**

- G94 is modal;
- Starting point of cutting: starting position of linear interpolation (cutting feed). Unit: mm;
- End point of cutting: end position of linear interpolation (cutting feed). Unit: mm;
- X: X absolute coordinate of end point of cutting. Unit: mm;
- U: Different value of absolute coordinate from end point to starting point of cutting in X direction .Unit: mm;
- Z: Z absolute coordinates of end point of cutting, Unit: mm;
- W: Different value of X absolute coordinate from end point to starting point of cutting, Unit: mm;
- R: Different value(R value) of X absolute coordinates from end point to starting point of cutting. When the sign of R is not the same as that of U,  $|R| \leq |W|$ .

Radial linear cutting is shown in Fig. 3-21, radial taper cutting is as Fig. 3-22.

Ranges of X, U, Z, W, R are referred to Table 1-2 of Section 1.4.1, unit: mm/inch.

**Cycle process:**

- ① Z rapidly traverses from starting point to cutting starting point;
- ② Cutting feed (linear interpolation) from the cutting starting point to cutting end point;
- ③ Z executes the tool retraction at the cutting feedrate (opposite direction to the above-mentioned ①), and returns to the position which the absolute coordinates and the starting point are the same;
- ④ The tool rapidly traverses to return to the starting point and the cycle is completed.

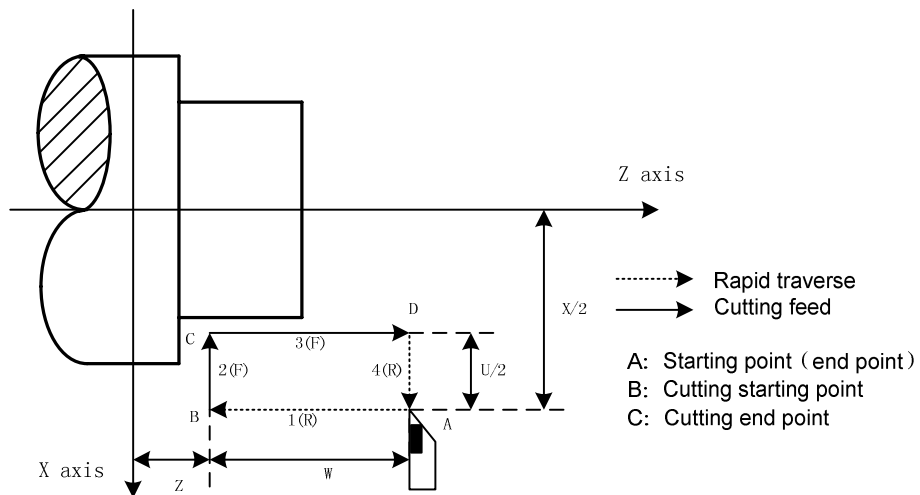

Fig. 3-21

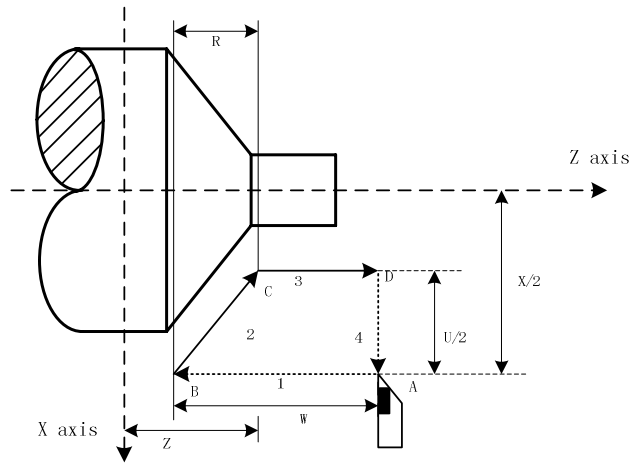

Fig. 3-22

Cutting path: Relative position between cutting end point and starting point with U, W is shown in Fig.3-23:

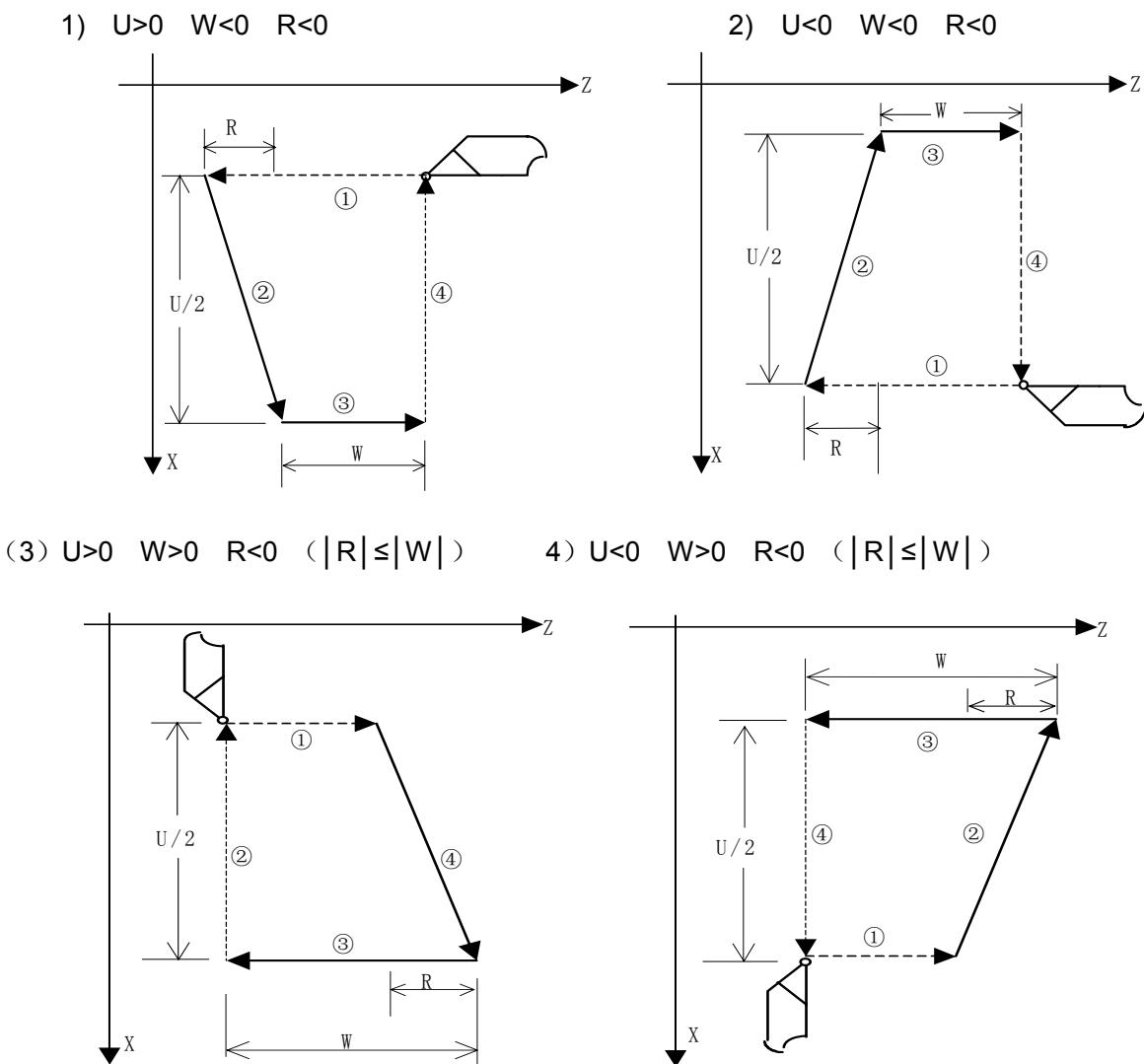

Fig. 3-23

Example: Fig. 3-24, rod  $\Phi 125 \times 112$

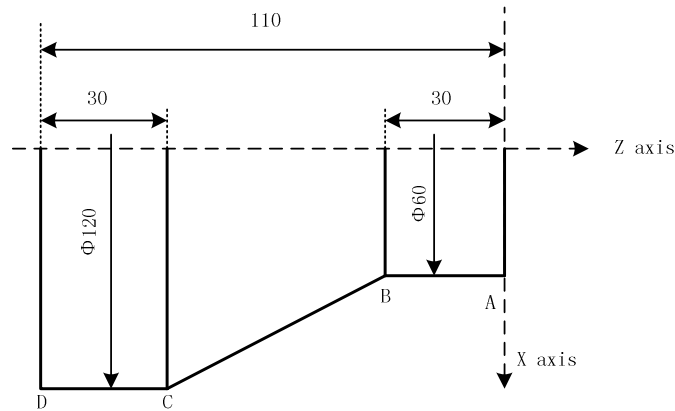

Fig. 3-24

Program: O0003;

```

G00 X130 Z5 M3 S1;
G94 X0 Z0 F200
X120 Z-110 F300;
G00 X120 Z0
G94 X108 Z-30 R-10
X96 R-20
X84 R-30
X72 R-40
X60 R-50;
M30;
    
```

} End face cutting  
 (Outer cutting  $\Phi 120$ )

} (C→B→A, cutting  $\Phi 60$ )

### 3.19.3 Caution of fixed cycle commands

1) After X(U) , Z(W) , R are executed in the canned cycle command, their command values are value if X(U) , Z(W) ,R are not redefined by executing a new canned cycle commands. The command values of X(U) ,Z(W) ,R are cleared if non-modal G command(00 Group) except for G04 or G00, G01, G02, G03, G32 is executed.

2) In MDI mode, the previous canned cycle can be executed by pressing the cycle start key after the canned cycle is completed.

3) One cycle cannot be executed repetitively in G90~G94 when the next block of G90~G94 is M, S, T command; the previous cycle is executed repetitively in G90~G94 when the next block is ended(EOB;).

Example: ...

```

N010 G90 X20.0 Z10.0 F400;
N011 ; (execute G90 one time repetitively)
    
```

...

4) Pause or single block is executed in G90, G94, the single block stops after the tool moves end point of current path.

## 3.20 Multiple Cycle Commands

Multiple cycle commands of the system includes axial roughing cycle G71, radial roughing cycle G72, closed cutting cycle G73, finishing cycle G70, axial grooving multiple cycle G74, axial grooving multiple cycle G75 and multiple thread cutting cycle G76. When the system executes these commands, it automatically counts the cutting times and the cutting path according to the programmed path, travels of tool infeed and tool retraction, executes multiple machining cycle (tool infeed → cutting→retract tool→tool infeed ), automatically completes the roughing, finishing workpiece and the starting point and the end point of command are the same one.

### 3.20.1 Axial roughing cycle G71

G71 has two kinds of roughing cycle: type I and type II.

**Command format:** G71 U( $\Delta d$ ) R( $e$ ) F\_\_ S\_\_ T\_\_; (1)

G71 P( $ns$ ) Q( $nf$ ) U( $\Delta u$ ) W( $\Delta w$ ) K0/1 J0/1; (2)

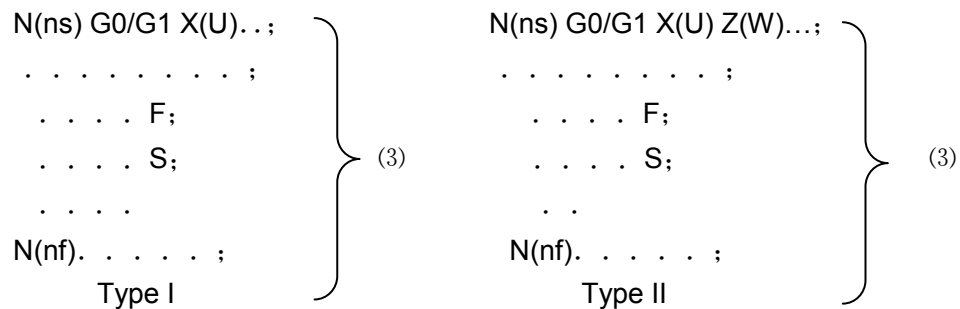

**Command function: G71 is divided into three parts:**

- (1) 1st blocks for defining the travels of tool infeed and retract tool, the cutting feedrate, the spindle speed and the tool function when roughing;
- (2) 2nd blocks for defining the block interval, finishing allowance;
- (3) 3rd blocks for some continuous finishing path, counting the roughing path without being executed actually when executing G71.

According to the finishing path, the finishing allowance, the path of tool infeed and tool retract, the system automatically counts the path of roughing, the tool cuts the workpiece in paralleling with Z, and the roughing is completed by multiple executing the cutting cycle tool infeed→cutting→tool retraction. The starting point and the end point are the same one. The command is applied to the formed roughing of non-formed rod.

**Relevant definitions:**

**Finishing path:** The above-mentioned Part 3 of G71( $ns\sim nf$  block) defines the finishing path, and the starting point of finishing path (starting point of  $ns$  block) is the same these of starting point and end point of G71, called A point; the first block of finishing path ( $ns$  block) is used for X rapid traversing or tool infeed, and the end point of finishing path is called to B point; the end point of finishing path (end point of  $nf$  block) is called to C point. The finishing path is A→B→C.

**Roughing path:** The finishing path is the one after offsetting the finishing allowance( $\Delta u, \Delta w$ ) and is the path contour formed by executing G71. A, B, C point of finishing path after offset corresponds separately to A', B', C' point of roughing path, and the final continuous cutting path of G71 is B'→C' point.

$\Delta d$ : It is each travel(unit: mm, radius value) of X tool infeed in roughing, its value: 0.001~99.999(unit: mm/inch, radius value) without sign, and the direction of tool infeed is defined by move direction of ns block. The command value  $\Delta d$  is reserved after executing U( $\Delta d$ ) and the value of system parameter No.051 is rewritten to  $\Delta d \times 1000$ (unit: 0.001 mm). The value of system parameter No.051 is regarded as the travel of tool infeed when U( $\Delta d$ ) is not input.

e: It is travel (unit: mm/inch, radius value) of X tool retraction in roughing its value: 0.001~99.999 (unit: mm, radius value) without sign, and the direction of tool retraction is opposite to that of tool infeed, the command value e is reserved and the value of system parameter No.052 is rewritten to  $e \times 1000$ (unit: 0.001 mm) after R(e) is executed. The value of system parameter No.052 is regarded as the travel of tool retraction when R(e) is not input.

ns: Block number of the first block of finishing path.

nf: Block number of the last block of finishing path.

$\Delta u$ : X finishing allowance is  $\pm 99999999 \times$  least input increment with sign symbol (diameter, unit: mm/inch, with sign). X coordinate offset of roughing path compared to finishing path, i.e. the different value of X absolute coordinates between A' and A. The system defaults  $\Delta u=0$  when U( $\Delta u$ ) is not input, i.e. there is no finishing allowance in X direction for roughing cycle.

$\Delta w$ : Z finishing allowance is  $\pm 99999999 \times$  least input increment with sign symbol (diameter, unit: mm/inch, with sign). the Z coordinate offset of roughing path compared to finishing path, i.e. the different value of Z absolute coordinate between A' and A. The system defaults  $\Delta w=0$  when W( $\Delta w$ ) is not input, i.e. there is no Z finishing allowance for roughing cycle.

K: When K is not input or is not 1, the system does not check the program monotonicity except that the Z value of starting point and end point of the arc or ellipse or parabola or the arc is more than 180 degree; K=1, the system checks the program monotonicity.

F: Feedrate; S: Spindle speed; T: Tool number, tool offset number.

M, S, T, F: They can be specified in the first G71 or the second ones or program ns~nf. M, S, T, F functions of M, S, T, F blocks are invalid in G71, and they are valid in G70 finishing blocks.

### Type I:

#### 1) Execution process: (Fig. 3-25)

- ① X rapidly traverses to A' from A point, X travel is  $\Delta u$ , and Z travel is  $\Delta w$ ;
- ② X moves from A' is  $\Delta d$ ( tool infeed), ns block is for tool infeed at rapid traverse speed with G0, is for tool infeed at feedrate F with G71, and its direction of tool infeed is that of A→B point;
- ③ Z executes the cutting feeds to the roughing path, and its direction is the same that of Z coordinate A→B point;
- ④ X, Z execute the tool retraction e (45° straight line) at feedrate, the directions of tool retraction is opposite to that of too infeed;
- ⑤ Z rapidly retracts at rapid traverse speed to the position which is the same that of Z coordinate;
- ⑥ After executing X tool infeed ( $\Delta d+e$ )again, the end point of traversing tool is still on the middle point of straight line between A' and B'(the tool does not reach or exceed B'), and after executing the tool infeed ( $\Delta d+e$ )again, execute ③; after executing the tool infeed ( $\Delta d+e$ )again, the end point of tool traversing reaches B' point or exceeds the straight line



between A'→B' point and X executes the tool infeed to B' point, and then the next step is executed;

- ⑦ Cutting feed from B' to C' point along the roughing path;
- ⑧ Rapid traverse to A from C' point and the program jumps to the next block following nF block after G71 cycle is ended.

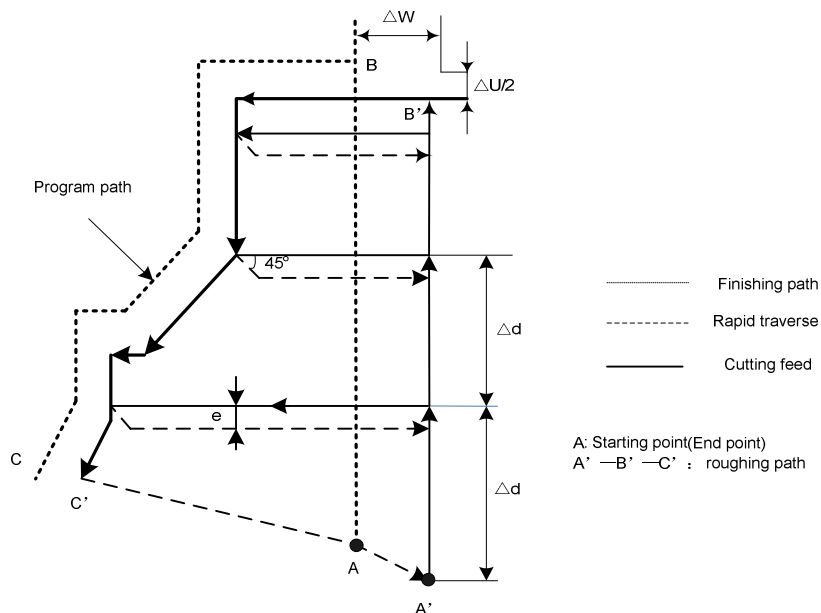

Fig. 3-25 G71 cycle path

2) Coordinate offset direction with finishing allowance:

Δu, Δw define the coordinate offset and cut-in direction in finishing, and their sign symbol are as follows Fig. 3-26: B→C for finishing path, B'→C' for roughing path and A is the tool start-up point.

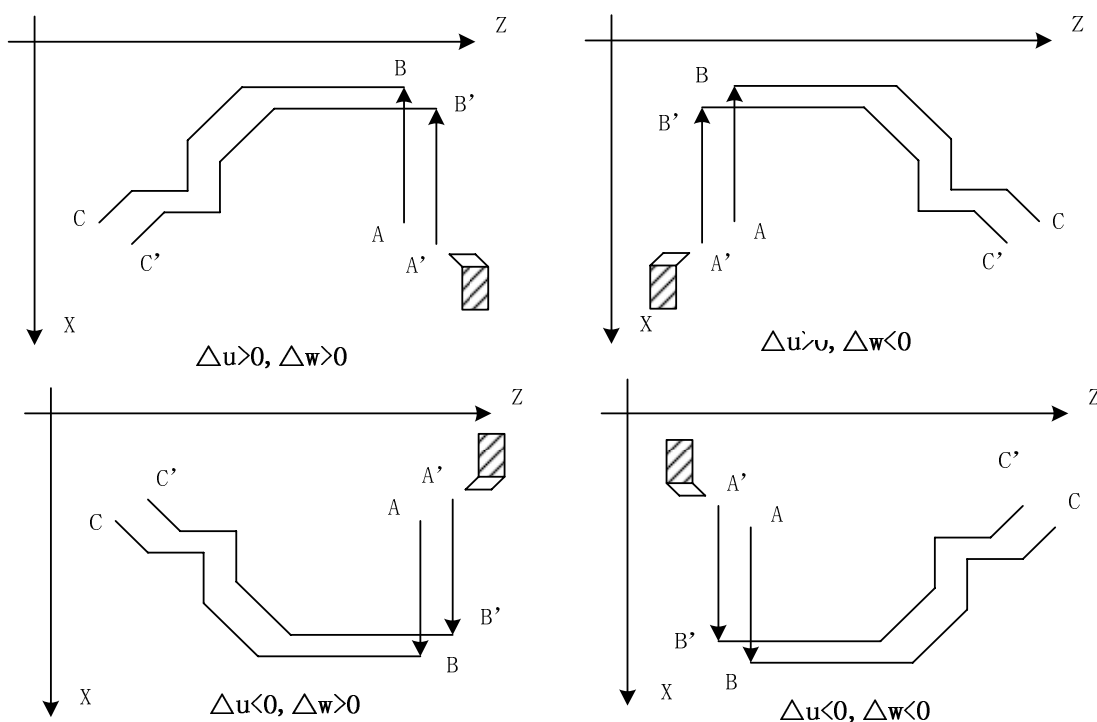

Fig.3-26

**Type II:**

The type II is different from the type I as follows:

- 1) Relative definition: more one parameter than the type I .
- J: When J is not input or J is not 1, the system does not execute the run along the roughing contour; J=1: the system executes the run along the roughing contour.
- 2) The system does not execute the monotonous increasing or the monotonous decreasing along X external contour, and the workpiece can be up to 10 grooves as follows:

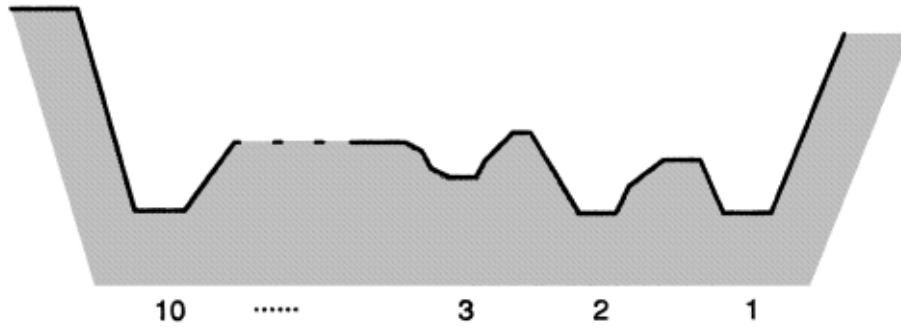

Fig. 3-26-1 (type II)

But, the Z external contour must be the monotonous increasing or the monotonous decreasing, and the following contour cannot be machined:

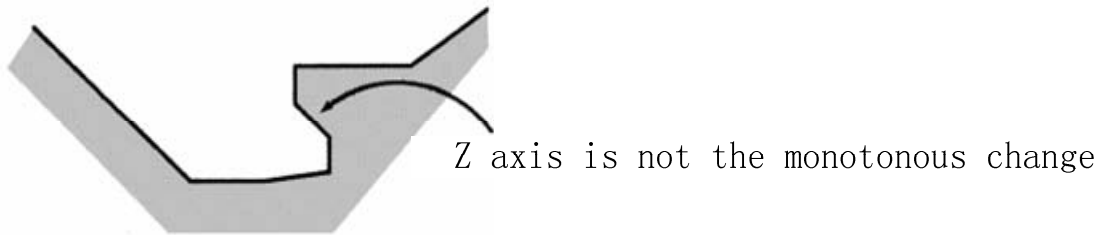

Fig. 3-26-2 (type II)

- 3) The first tool cutting need not the vertical: the machining can be executed when Z is the monotonous change shape as follows:

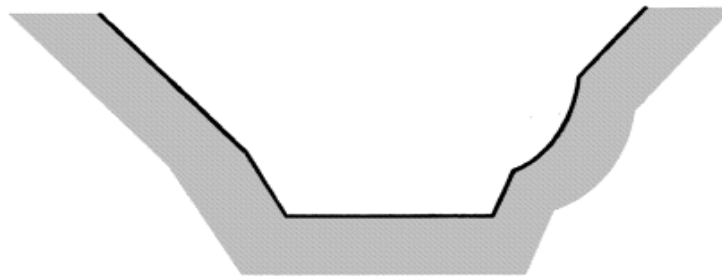

Fig. 3-26-3



blocks repetitively;

- ns~nf blocks are used for counting the roughing path and the blocks are not executed when G71 is executed. F, S, T commands of ns~nf blocks are invalid when G71 is executed, at the moment, F, S, T commands of G71 blocks are valid. F, S, T of ns~nf blocks are valid when executing ns~nf to command G70 finishing cycle;
- In ns~nf blocks, there are only G commands: G00, G01, G02, G03, G04, G05, G6.2, G6.3, G7.2, G7.3, G96, G97, G98, G99, G40, G41, G42 and the system cannot call subprograms (M98/M99);
- G96, G97, G98, G99, G40, G41, G42 are invalid when G71 is executed, and are valid when G70 is executed;
- When G71 is executed, the system can stop the automatic run and manual traverse, but return to the position before manual traversing when G71 is executed again, otherwise, the following path will be wrong;
- When the system is executing the feed hold or single block, the program pauses after the system has executed end point of current path;
- $\Delta d, \Delta u$  are specified by the same U and different with or without being specified P, Q commands;
- G71 cannot be executed in MDI, otherwise, the system alarms;
- There are no the same block number in ns~nf when compound cycle commands are executed repetitively in one program;
- The tool retraction point should be high or low as possible to avoid crashing the workpiece.

Example: Fig. 3-73 (Type I)

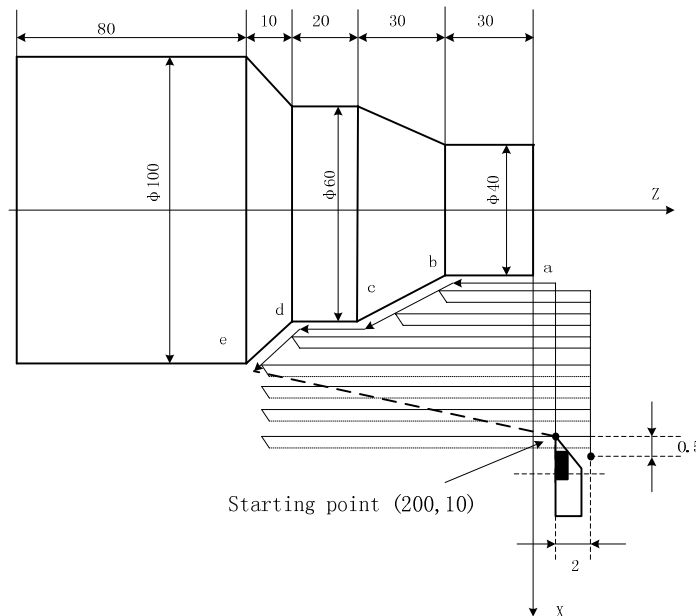

Fig. 3-27

**Program: O0004;**

G00 X200 Z10 M3 S800; (Spindle clockwise with 800 r/min)

G71 U2 R1 F200; (Cutting depth each time 4mm, tool retraction 2mm [in diameter])

G71 P80 Q120 U0.5 W0.2; (roughing a---e, machining allowance: X, 1mm;Z, 2mm)

N80 G00 X40 S1200;	(Positioning)	} a→b→c→d→e blocks for finishing path
G01 Z-30 F100 ;	(a→b)	
X60 W-30;	(b→c)	
W-20;	(c→d)	
N120 X100 W-10;	(d→e)	
G70 P80 Q120;	(a---e blocks for finishing path)	
M30;	(End of block)	

### 3.20.2 Radial roughing cycle G72

**Command format:** G72 W( $\Delta d$ ) R(e) F\_\_ S\_\_ T\_\_; (1)

G72 P(ns) Q(nf) U( $\Delta u$ ) W( $\Delta w$ ); (2)

N\_\_(ns) . . . . . ;  
 . . . . . ;  
 . . . . F;  
 . . . . S;  
 . . . . ;  
 .  
 N\_\_(nf). . . . . ; (3)

**Command function:** G72 is divided into three parts:

- (1) 1st blocks for defining the travels of tool infeed and tool retraction, the cutting speed, the spindle speed and the tool function in roughing;
- (2) 2nd blocks for defining the block interval, finishing allowance;
- (3) 3rd blocks for some continuous finishing path, counting the roughing path without being executed actually when G72 is executed.

According to the finishing path, the finishing allowance, the path of tool infeed and retract tool, the system automatically counts the path of roughing, the tool cuts the workpiece in paralleling with Z, and the roughing is completed by multiple executing the cutting cycle tool infeed→cutting feed→tool retraction. The starting point and the end point of G72 are the same one. The command is applied to the formed roughing of non-formed rod.

**Relevant definitions:**

**Finishing path:** the above-mentioned Part (3) of G71(ns~nf block) defines the finishing path, and the starting point of finishing path (i.e. starting point of ns block) is the same these of starting point and end point of G72, called A point; the first block of finishing path(ns block) is used for Z rapid traversing or cutting feed, and the end point of finishing path is called to B point; the end point of finishing path(end point of nf block) is called to C point. The finishing path is A→B→C.

**Roughing path:** The finishing path is the one after offsetting the finishing allowance( $\Delta u$ ,  $\Delta w$ ) and is the path contour formed by executing G72. A, B, C point of finishing path after offset corresponds separately to A', B', C' point of roughing path, and the final continuous cutting path of G72 is B'→C' point.

$\Delta d$ : it is Z cutting in roughing, its value: 0.001~99.999(unit: mm/inch) without sign symbol, and the direction of tool infeed is determined by ns block traverse direction. the specified value

$\Delta d$  is reserved and the data value is switched to the corresponding value to save to No.051 after  $W(\Delta d)$  is executed. The value of system parameter No.051 is regarded as the tool infeed clearance when  $R(e)$  is not input.

$e$ : it is Z tool retraction clearance in roughing, its value: 0~99.999(unit: mm) without sign symbol, and the direction of tool retraction is opposite to that of tool infeed, the specified value  $e$  is reserved and the data value is switched to the corresponding value to save to No.052 after  $R(e)$  is executed. The value of system parameter No.052 is regarded as the tool retraction clearance when  $R(e)$  is not input.

$ns$ : Block number of the first block of finishing path.

$nf$ : Block number of the last block of finishing path.

$\Delta u$ : it is X finishing allowance in roughing, its range:  $\pm 99999999 \times$  least input increment(X coordinate offset of roughing contour corresponding to the finishing path, i.e. X absolute coordinate difference between  $A'$  and A.(diameter, unit: mm/inch, with sign symbol).

$\Delta w$ : it is Z finishing allowance in roughing, its range:  $\pm 99999999 \times$  least input increment(Z coordinate offset of roughing contour corresponding to the finishing path, i.e. Z absolute coordinate difference between  $A'$  and A.(diameter, unit: mm/inch, with sign symbol).

F: Cutting feedrate; S: Spindle speed; T: Tool number, tool offset number.

M, S, T, F: They can be specified in the first G72 or the second ones or program  $ns \sim nf$ . M, S, T, F functions of M, S, T, F blocks are invalid in G72, and they are valid in G70 finishing blocks.

#### Execution process: Fig. 3-28

- ① X rapidly traverses to  $A'$  from A point, X travel is  $\Delta u$ , and Z travel is  $\Delta w$ ;
- ② X moves from  $A'$  is  $\Delta d$ ( tool infeed),  $ns$  block is for tool infeed at rapid traverse speed with G0, is for tool infeed at G72 feedrate F in G1, and its direction of tool infeed is that of  $A \rightarrow B$  point;
- ③ X executes the cutting feeds to the roughing path, and its direction is the same that of X coordinate  $B \rightarrow C$  point;
- ④ X, Z execute the tool retraction  $e$  ( $45^\circ$  straight line) at feedrate, the directions of tool retraction is opposite to that of tool infeed ;
- ⑤ X rapidly retracts at rapid traverse speed to the position which is the same that of Z coordinate;
- ⑥ After Z tool infeed ( $\Delta d + e$ ) again is executed, the end point of traversing tool is still on the middle point of straight line between  $A'$  and  $B'$  (the tool does not reach or exceed  $B'$ ), and after Z executes the tool infeed ( $\Delta d + e$ ) again, ③ is executed; after the tool infeed ( $\Delta d + e$ ) is executed again, the end point of tool traversing reaches  $B'$  point or exceeds the straight line between  $A' \rightarrow B'$  point and Z executes the tool infeed to  $B'$  point, and then the next step is executed;
- ⑦ Cutting feed from  $B'$  to  $C'$  point along the roughing path;
- ⑧ Rapidly traverse to A from  $C'$  point and the program jumps to the next clock following  $nf$  block after G71 cycle is completed.

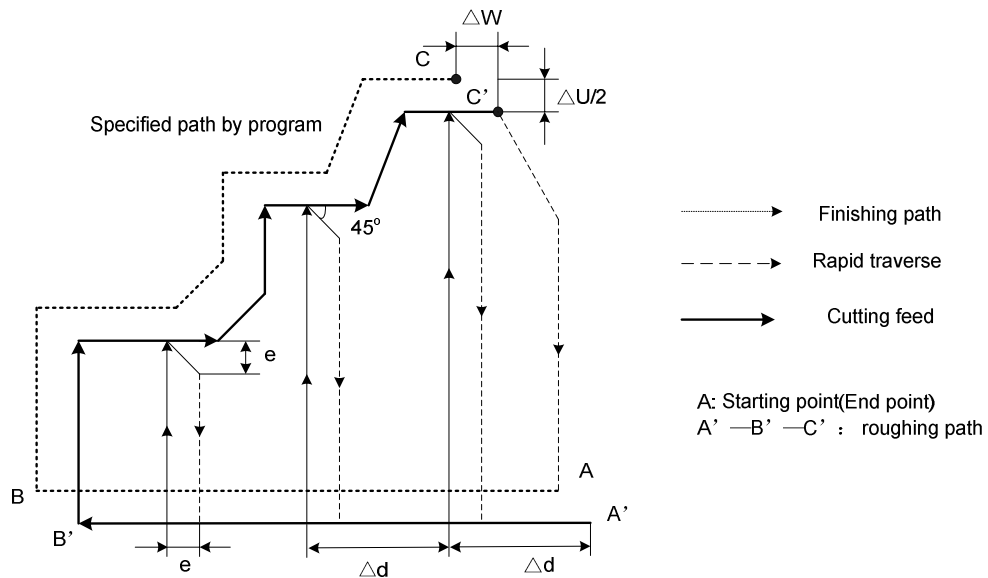

Fig. 3-28

**Command specifications:**

- ns~nf blocks in programming must be followed G72 blocks. If they are in the front of G72 blocks, the system automatically searches and executes ns~nf blocks, and then executes the next program following nf block after they are executed, which causes the system executes ns~nf blocks repetitively;
- ns~nf blocks are used for counting the roughing path and the blocks are not executed when G72 is executed. F, S, T commands of ns~nf blocks are invalid when G72 is executed, at the moment, F, S, T commands of G72 blocks are valid. F, S, T of ns~nf blocks are valid when executing ns~nf to command G70 finishing cycle;
- There are G00, G01 without the word X(U) in ns block, otherwise the system alarms;
- The dimensions in X, Z direction must be changed monotonously (always increasing or reducing) for the finishing path;
- In ns~nf blocks, there are only G commands: G01, G02, G03, G04, G05, G6.2, G6.3, G7.2, G7.3, G96, G97, G98, G99, G40, G41, G42 and the system cannot call subprograms (M98/M99);
- G96, G97, G98, G99, G40, G41, G42 are invalid when G72 is executed, and are valid when G70 is done;
- When G72 is executed, the system can stop the automatic run and manual traverse, but return to the position before manual traversing when G72 is executed again, otherwise, the following path will be wrong;
- When the system is executing the feed hold or single block, the program pauses after the system has executed end point of current path;
- $\Delta d$ ,  $\Delta u$  are specified by the same U and different with or without being specified P, Q commands;
- There are no the same block number in ns~nf when compound cycle commands are executed repetitively in one program;
- G72 cannot be executed in MDI, otherwise, the system alarms;
- The tool retraction point should be high or low as possible to avoid crashing the workpiece.

**Coordinate offset direction with finishing allowance:**

$\Delta u$ ,  $\Delta w$  define the coordinate offset and its direction of cut-in in finishing, and their sign symbol are as follows Fig. 3-29: B→C for finishing path, B'→C' for roughing path and A is the tool start-up point.

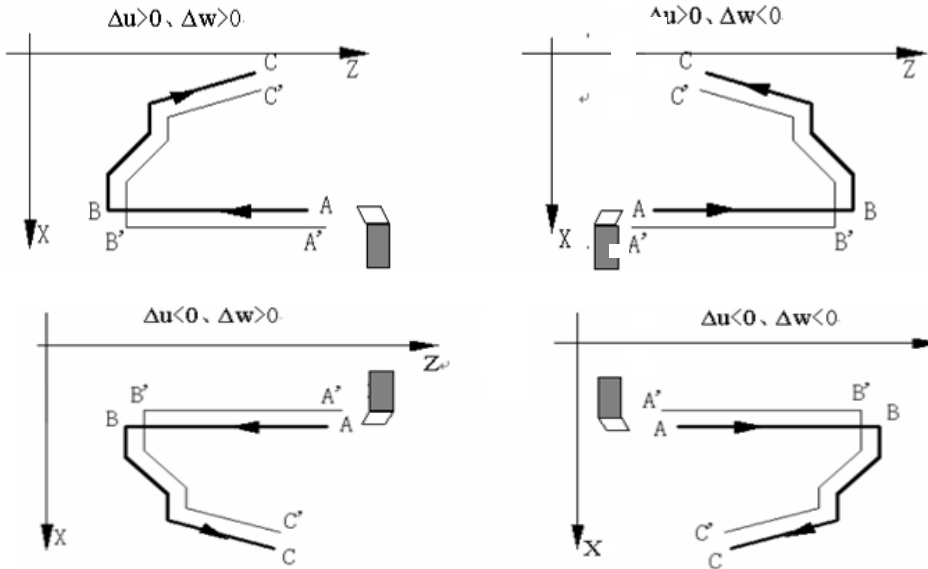

Fig.3-29

Example: Fig. 3-30

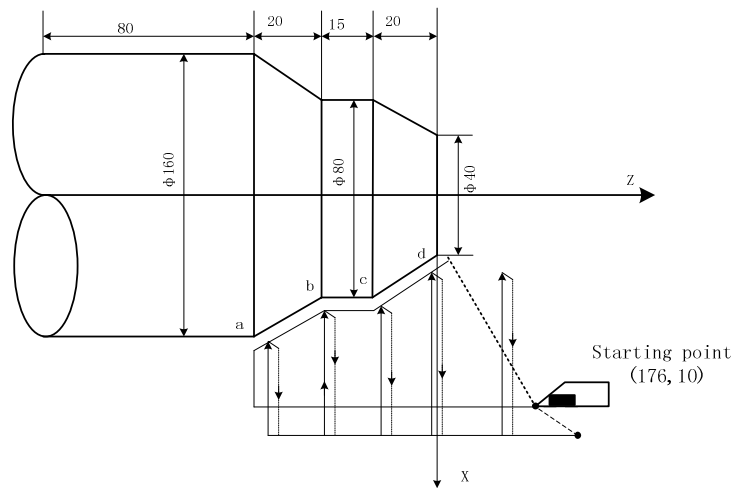

Fig.3-30

Program:

```

O0005;
G00 X176 Z10 M03 S500 (Change No.2 tool and execute its compensation, spindle
                        CW rotation with 500 r/min)
G72 W2.0 R0.5 F300; (Tool infed 2mm, tool retraction 0.5mm)
G72 P10 Q20 U0.2 W0.1; (Roughing a--d,X roughing allowance 0.2mm and Z 0.1mm)
    
```



N10 G00 Z-55 S800 ;	(Rapid traverse)	}	Blocks for finishing path
G01 X160 F120;	(Infeed to a point)		
X80 W20;	(Machining a—b)		
W15;	(Machining b—c)		
N20 X40 W20 ;	(Machining c—d)		
G70 P050 Q090 M30;	(Finishing a—d)		

### 3.20.3 Closed cutting cycle G73

**Command format:** G73 U( $\Delta i$ ) W ( $\Delta k$ ) R (d) F\_\_ S\_\_ T\_\_ ; (1)

G73 P(ns) Q(nf) U( $\Delta u$ ) W( $\Delta w$ ); (2)

N\_\_(ns) . . . . . ;  
 . . . . . ;  
 . . . . F ;  
 . . . . S ;  
 . . . . ;  
 .  
 N\_\_(nf) . . . . . ;

(3)

**Command functions:** G73 is divided into three parts:

- (1) Blocks for defining the travels of tool infeed and tool retraction, the cutting speed, the spindle speed and the tool function when roughing;
- (2) Blocks for defining the block interval, finishing allowance;
- (3) Blocks for some continuous finishing path, counting the roughing path without being executed actually when executing G73.

According to the finishing allowance, the travel of tool retraction and the cutting times, the system automatically counts the travel of roughing offset, the travel of each tool infeed and the path of roughing, the path of each cutting is the offset travel of finishing path, the cutting path approaches gradually the finishing one, and last cutting path is the finishing one according to the finishing allowance. The starting point and end point of G73 are the same one, and G73 is applied to roughing for the formed rod. G73 is non-modal and its path is shown in Fig.3-31.

**Relevant definitions:**

**Finishing path:** The above-mentioned Part 3 of G73 (ns~nf block) defines the finishing path, and the starting point of finishing path (start point of ns block) is the same as these of starting point and end point of G73, called A point; the end point of the first block of finishing path (ns block) is called B point; the end point of finishing path (end point of nf block) is called C point. The finishing path is A→B→C.

**Roughing path:** It is one group of offset path of finishing one, and the roughing path times are the same as that of cutting. After the coordinates offset, A, B, C of finishing path separately corresponds to  $A_n$ ,  $B_n$ ,  $C_n$  of roughing path (n is the cutting times, the first cutting path is  $A_1$ ,  $B_1$ ,  $C_1$  and the last one is  $A_d$ ,  $B_d$ ,  $C_d$ ). The coordinates offset value of the first cutting compared to finishing path is  $(\Delta i \times 2 + \Delta u, \Delta w + \Delta k)$  (diameter programming), the coordinates offset value of the last cutting compared to finishing path is  $(\Delta u, \Delta w)$ , the coordinates offset value of each cutting compared to the previous one is as follows:

$\Delta i$ : It is X tool retraction clearance in roughing, and its range is  $\pm 99999999 \times$  least input increment (radius, unit: mm/inch, with sign symbol),  $\Delta i$  is equal to X coordinate offset

value (radius value) of A1 point compared to Ad point. The X total cutting travel(radius value) is equal to  $|\Delta i|$  in roughing, and X cutting direction is opposite to the sign of  $\Delta i$ :  $\Delta i > 0$ , the system executes X negative cutting in roughing. It is reserved after  $\Delta i$  specified value is executed and the data is switched to the corresponding value to save to NO.053. The No.053 value is regarded as X tool retraction clearance in roughing when  $U(\Delta i)$  is not input.

$\Delta k$ : It is Z tool retraction clearance in roughing, and its range is  $\pm 99999999 \times$  least input increment (radius, unit: mm/inch, with sign symbol) ,  $\Delta k$  is equal to Z coordinate offset value (radius value) of A1 point compared to Ad point. Z total cutting travel(radius value) is equal to  $|\Delta k|$  in roughing, and Z cutting direction is opposite to the sign of  $\Delta k$ :  $\Delta i > 0$ , the system executes Z negative cutting in roughing. It is reserved after  $\Delta k$  specified value is executed and the data is switched to the corresponding value to save to NO.054. The No.054 value is regarded as Z tool retraction clearance in roughing when  $W(\Delta k)$  is not input.

d: It is the cutting times 1~9999 (unit: times). R5 means the closed cutting cycle is completed by 5 times cutting. R (d) is reserved after it is executed and NO.055 value is rewritten to d (unit: times). No.055 value is regarded as the cutting times when R(d) is not input. When the cutting times is 1, the system completes the closed cutting cycle based on 2 times cutting.

ns: Block number of the first block of finishing path.

nf: Block number of the last block of finishing path.

$\Delta u$ : It is X finishing allowance and its range is  $\pm 99999999 \times$  least input increment (diameter, unit: mm/inch, with sign symbol) and is the X coordinate offset of roughing path compared to finishing path, i.e. the different value of X absolute coordinates of  $A_1$  compared to A.  $\Delta u > 0$ , it is the offset of the last X positive roughing path compared to finishing path. The system defaults  $\Delta u = 0$  when  $U(\Delta u)$  is not input, i.e. there is no X finishing allowance for roughing cycle.

$\Delta w$ : It is Z finishing allowance and its range is  $\pm 99999999 \times$  least input increment (diameter, unit: mm/inch, with sign symbol) and is the X coordinate offset of roughing path compared to finishing path, i.e. the different value of Z absolute coordinates of  $A_1$  compared to A.  $\Delta w > 0$ , it is the offset of the last X positive roughing path compared to finishing path. The system defaults  $\Delta w = 0$  when  $W(\Delta w)$  is not input, i.e. there is no Z finishing allowance for roughing cycle.

F: Feedrate; S: Spindle speed; T: Tool number, tool offset number.

M, S, T, F: They can be specified in the first G73 or the second ones or program ns~nf. M, S, T, F functions of M, S, T, F blocks are invalid in G73, and they are valid in G70 finishing blocks.

**Execution process:** (Fig. 3-31)

①  $A \rightarrow A_1$ : Rapid traverse;

② First roughing  $A_1 \rightarrow B_1 \rightarrow C_1$  :

$A_1 \rightarrow B_1$ : Rapid traverse speed in ns block in G0, cutting feedrate specified by G73 in ns block in G1;

$B_1 \rightarrow C_1$ : Cutting feed.

③  $C_1 \rightarrow A_2$ : Rapid traverse.

④ Second roughing  $A_2 \rightarrow B_2 \rightarrow C_2$  :

$A_2 \rightarrow B_2$ : Rapid traverse speed in ns block in G0, cutting feedrate specified by G73 in ns block in G1;

$B_2 \rightarrow C_2$ : Cutting feed.

⑤  $C_2 \rightarrow A_3$ : Rapid traverse:

.....

No. n times roughing,  $A_n \rightarrow B_n \rightarrow C_n$  :

$A_n \rightarrow B_n$ : ns Rapid traverse speed in ns block in G0, cutting feedrate specified by G73 in ns block in G1;

$B_n \rightarrow C_n$ : Cutting feed.

$C_n \rightarrow A_{n+1}$ : Rapid traverse;

.....

Last roughing,  $A_d \rightarrow B_d \rightarrow C_d$  :

$A_d \rightarrow B_d$ : Rapid traverse speed in ns block in G0, cutting feedrate specified by G73 in ns block in G1;

$B_d \rightarrow C_d$ : Cutting feed.

$C_d \rightarrow A$ : Rapid traverse to starting point;

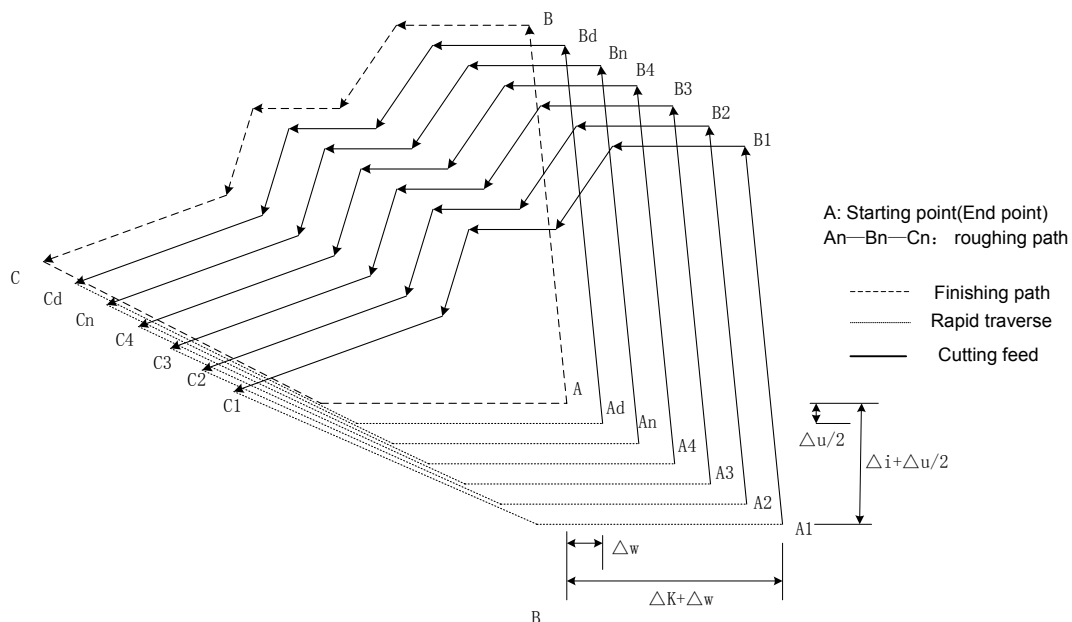

Fig. 3-31 G73 path

#### Command specifications:

- $ns \sim nf$  blocks in programming must be followed G73 blocks. If they are in the front of G73 blocks, the system automatically searches and executes  $ns \sim nf$  blocks, and then executes the next program following  $nf$  block after they are executed, which causes the system executes  $ns \sim nf$  blocks repetitively.
- $ns \sim nf$  blocks are used for counting the roughing path and the blocks are not executed when G73 is executed. F, S, T commands of  $ns \sim nf$  blocks are invalid when G71 is executed, at the moment, F, S, T commands of G73 blocks are valid. F, S, T of  $ns \sim nf$  blocks are valid when executing  $ns \sim nf$  to command G70 finishing cycle.
- There are only G00, G01 in ns block.
- In  $ns \sim nf$  blocks, there are only G commands: G00, G01, G02, G03, G04, G05, G6.2, G6.3, G7.2, G7.3, G96, G97, G98, G99, G40, G41, G42 and the system cannot call subprograms (M98/M99).

- G96, G97, G98, G99, G40, G41, G42 are invalid when G73 is executed, and are valid when G70 is executed.
- When G73 is executed, the system can stop the automatic run and manual traverse, but return to the position before manual traversing when G73 is executed again, otherwise, the following path will be wrong.
- When the system is executing the feed hold or single block, the program pauses after the system has executed end point of current path.
- $\Delta i$ ,  $\Delta u$  are specified by the same U and  $\Delta k$ ,  $\Delta w$  are specified by the same W, and they are different with or without being specified P,Q commands.
- G73 cannot be executed in MDI, otherwise, the system alarms.
- There are no the same block number in ns~nf when compound cycle commands are executed repetitively in one program.
- The tool retraction point should be high or low as possible to avoid crashing the workpiece.

**Coordinate offset direction with finishing allowance:**

$\Delta i$ ,  $\Delta k$  define the coordinates offset and its direction of roughing;  $\Delta u$ ,  $\Delta w$  define the coordinate offset and the cut-in direction in finishing, and their sign symbols are as follows Fig. 3-32: A is tool start-up point, B→C for workpiece contour, B'→C' for roughing contour and B''→C'' for finishing path.

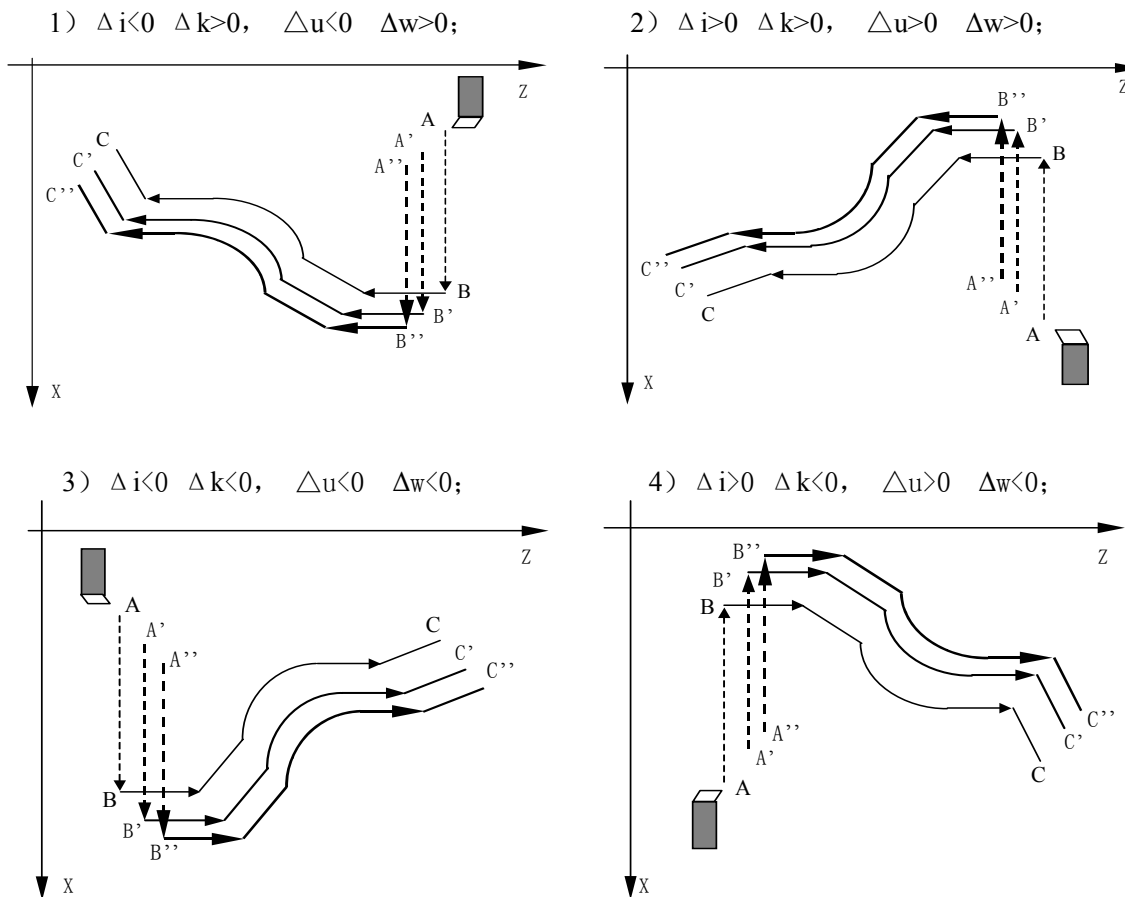

Fig.3-32

Example: Fig. 3-33

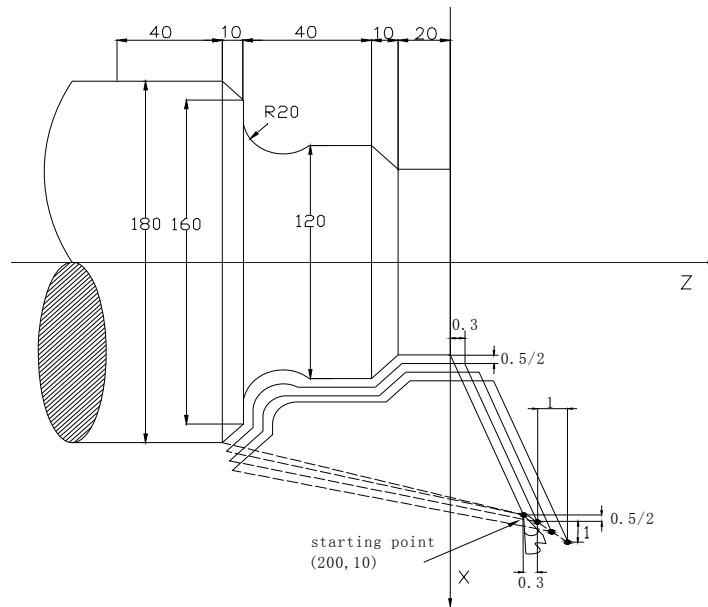

Fig.3-34

```

Program: O0006;
G99 G00 X200 Z10 M03 S500;      (Specify feedrate per rev and position starting point and
                                start spindle)

G73 U1.0 W1.0 R3 ;              (X tool retraction with 2mm, Z 1mm)
G73 P14 Q19 U0.5 W0.3 F0.3 ;    (X roughing with 0.5 allowance and Z 0.3mm)
N14 G00 X80 W-40 ;
G01 W-20 F0.15 S600 ;
X120 W-10 ;
W-20 ;
G02 X160 W-20 R20 ;
N19 G01 X180 W-10 ;
G70 P14 Q19 M30;

```

} Blocks for finishing  
(Finishing)

### 3.20.4 Finishing cycle G70

**Command format:** G70 P(ns) Q(nf);

**Command function:** The tool executes the finishing of workpiece from starting point along with the finishing path defined by ns~nf blocks. After executing G71, G72 or G73 to roughing, execute G70 to finishing and single cutting of finishing allowance is completed. The tool returns to starting point and execute the next block following G70 block after G70 cycle is completed.

ns: Block number of the first block of finishing path.

nf: Block number of the last block of finishing path.

G70 path is defined by programmed one of ns~nf blocks. Relationships of relative position of ns, nf block in G70~G73 blocks are as follows:

```

. . . . .
G71/G72/G73 .....;
N__(ns) . . . . .
. . . . .
. F
. S
.
.
N__(nf).....
. . .
G70 P(ns) Q(nf);
. . .

```

} Blocks for finishing path

**Command specifications:**

- ns~nf blocks in programming must be followed G70 blocks. If they are in the front of G71 blocks, the system automatically searches and executes ns~nf blocks, and then executes the next program following nf block after they are executed, which causes the system executes ns~nf blocks repetitively.
- F, S, T in ns~nf blocks are valid when executing ns~nf to command G70 finishing cycle.
- G96, G97, G98, G99, G40, G41, G42 are valid in G70;
- When G70 is executed, the system can stop the automatic run and manual traverse, but return to the position before manual traversing when G70 is executed again, otherwise, the following path will be wrong.
- When the system is executing the feed hold or single block, the program pauses after the system has executed end point of current path.
- G70 cannot be executed in MDI, otherwise, the system alarms.
- There are no the same block number in ns~nf when compound cycle commands are executed repetitively in one program.
- The tool retraction point should be high or low as possible to avoid crashing the workpiece.

**3.20.5 Axial grooving multiple cycle G74**

**Command format:** G74 R(e);

G74 X(U) \_\_ Z(W) \_\_ P( $\Delta$ i) Q( $\Delta$ k) R( $\Delta$ d) F\_\_;

**Command function:** Axial (X axis) tool infeed cycle compounds radial discontinuous cutting cycle: Tool infeeds from starting point in radial direction (Z), retracts, infeeds again, and again and again, and last tool retracts in axial direction, and retracts to the Z position in radial direction, which is called one radial cutting cycle; tool infeeds in axial direction and execute the next radial cutting cycle; cut to end point of cutting, and then return to starting point (starting point and end point are the same one in G74), which is called one radial grooving compound cycle. Directions of axial tool infeed and radial tool infeed are defined by relative position between end point X(U) Z(W) and starting point of cutting. G75 is used for machining radial loop groove or column surface by radial discontinuously cutting, breaking stock and stock removal.

**Relevant definitions:**

**Starting point of axial cutting cycle:** starting position of axial tool infeed for each axial cutting cycle, defining with  $A_n(n=1,2,3.....)$ , Z coordinate of  $A_n$  is

the same that of starting point A, the different value of X coordinate between  $A_n$  and  $A_{n-1}$  is  $\Delta i$ . The starting point  $A_1$  of the first axial cutting cycle is the same as the starting point A, and the X coordinate of starting point ( $A_f$ ) of the last axial cutting cycle is the same that of cutting end point.

**End point of axial tool infeed:** starting position of axial tool infeed for each axial cutting cycle, defining with  $B_n(n=1,2,3,\dots)$ , Z coordinate of  $B_n$  is the same that of cutting end point, X coordinate of  $B_n$  is the same that of  $A_n$ , and the end point ( $B_f$ ) of the last axial tool infeed is the same that of cutting end point.

**End point of radius tool retraction:** end position of radius tool infeed (travel of tool infeed is  $\Delta d$ ) after each axial cutting cycle reaches the end point of axial tool infeed, defining with  $C_n(n=1,2,3,\dots)$ , Z coordinate of  $C_n$  is the same that of cutting end point, and the different value of X coordinate between  $C_n$  and  $A_n$  is  $\Delta d$ ;

**End point of axial cutting cycle:** end position of axial tool retraction from the end point of radius tool retraction, defining with  $D_n(n=1, 2, 3,\dots)$ , Z coordinate of  $D_n$  is the same that of starting point, X coordinate of  $D_n$  is the same that of  $C_n$  (the different value of X coordinate between it and  $A_n$  is  $\Delta d$ );

**Cutting end point:** it is defined by  $X(U) \text{ --- } Z(W) \text{ ---}$ , and is defined with  $B_f$  of the last axial tool infeed.

**R(e):** it is the tool retraction clearance after each axial(Z) tool infeed, and its range is 0~99.999(unit: mm) without sign symbols. The specified value is reserved validly after R(e) is executed and the data is switched to the corresponding value to save to NO.056. The NO.056 value is regarded as the tool retraction clearance when R(e) is not input.

X: X absolute coordinate value of cutting end point  $B_f$  (unit: mm).

U: Different value of X absolute coordinate between cutting end point  $B_f$  and starting point.

Z: Z absolute coordinate value of cutting end point  $B_f$  (unit: mm).

W: Different value of Z absolute coordinates between cutting end point  $B_f$  and starting point.

**P( $\Delta i$ ):** radial(X) cutting for each axial cutting cycle, range:  $0 < \Delta i \leq 9999999 \times$  least input increment (unit: least input increment, diameter value, without sign symbol).

**Q( $\Delta k$ ):** radial(Z) cutting for each axial cutting cycle, range:  $0 < \Delta k \leq 9999999 \times$  least input increment (unit: least input increment, diameter value, without sign symbol).

**R( $\Delta d$ ):** radial (X) tool retraction after cutting to end point of axial cutting, range:  $0 \sim 99999999 \times$  least input increment (unit: mm/inch, diameter value, without sign symbol).. The radial (X) tool retraction clearance is 0 when the system defaults the axial cutting end point. The system defaults the tool retraction is executed in positive direction when X(U) and P( $\Delta i$ ) are omitted.

**Execution process:** (Fig. 3-34)

- ① Axial (Z) cutting feed  $\Delta k$  from the starting point of axial cutting cycle, feed in Z negative direction when the coordinates of cutting end point is less than that of starting point in Z direction, otherwise, feed in Z positive direction;
- ② Axial (Z) rapid tool retraction e and its direction is opposite to the feed direction of ①;
- ③ X executes the cutting feed ( $\Delta k + e$ ) again, the end point of cutting feed is still in it between starting point  $A_n$  of axial cutting cycle and end point of axial tool infeed, Z executes the cutting feed ( $\Delta k + e$ ) again and execute ②; after Z executing the cutting

- feed ( $\Delta k+e$ ) again, the end point of cutting feed is on  $B_n$  or is not on it between  $A_n$  and  $B_n$  cutting feed to  $B_n$  in Z direction and then execute ④;
- ④ Radial(X) rapid tool retraction  $\Delta d$  to  $C_n$ , when X coordinate of  $B_f$  (cutting end point) is less than that of A (starting point), retract tool in X positive, otherwise, retract tool in X negative direction;
  - ⑤ Axial(Z axial) rapid retract tool to  $D_n$ , No. n axial cutting cycle is completed. If the current axial cutting cycle is not the last one, execute ⑥; if it is the previous one before the last axial cutting cycle, execute ⑦;
  - ⑥ Radial(X axial)rapid tool infeed, and it direction is opposite to ④ retract tool. If the end point of tool infeed is still on it between A and  $A_f$  (starting point of last axial cutting cycle) after X executes the tool infeed ( $\Delta d+\Delta i$ ), i.e.  $D_n \rightarrow A_{n+1}$  and then execute ① (start the next axial cutting cycle); if X end point of tool infeed is not on it between  $D_n$  and  $A_f$  after tool infeed ( $\Delta d+\Delta i$ ), rapidly traverse to  $A_f$  and execute ① to start the first axial cutting cycle;
  - ⑦ X rapidly traverse to return to A, and G74 is completed.

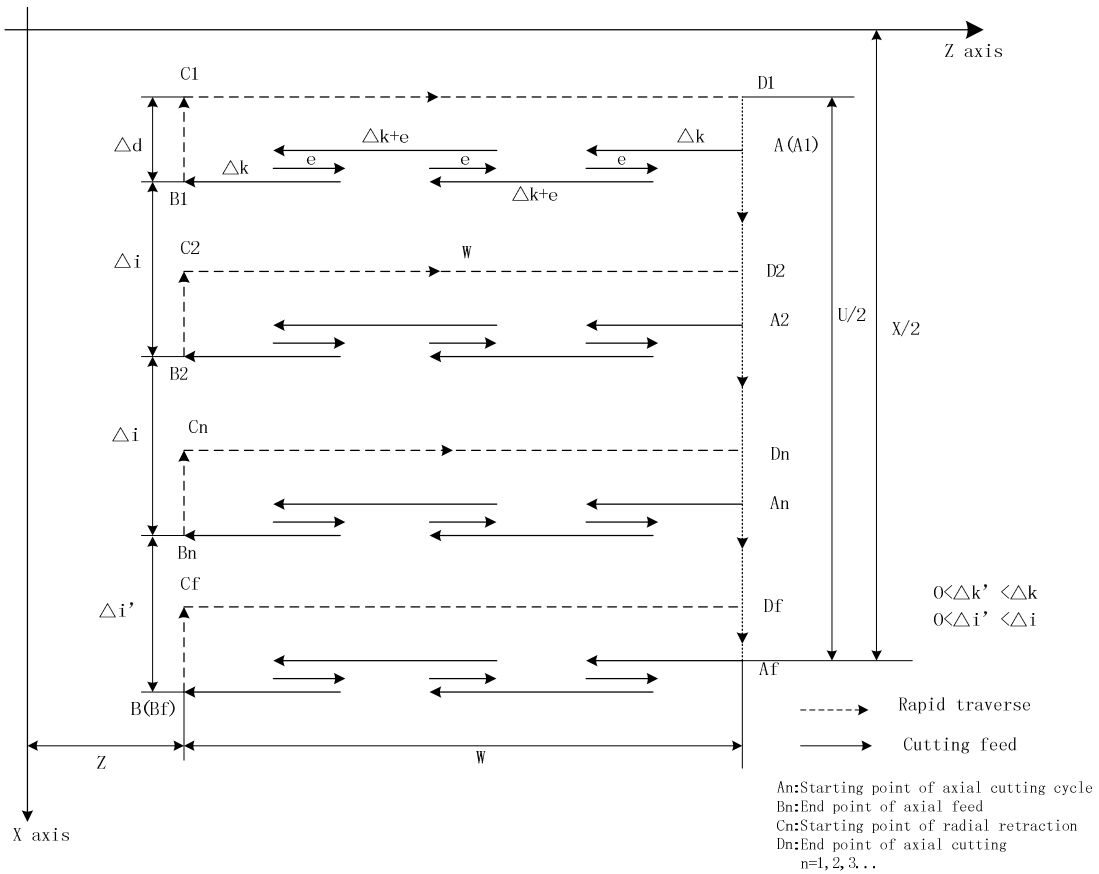

Fig. 3-34 G74 path

**Command specifications:**

- The cycle movement is executed by  $Z(W)$  and  $P(\Delta k)$  blocks of G74, and the movement is not executed if only "G74 R(e);" block is executed;
- $\Delta d$  and  $e$  are specified by the same address and whether there are  $Z(W)$  and  $P(\Delta k)$  word or not in blocks to distinguish them;
- The tool can stop in Auto mode and traverse in Manual mode when G74 is executed, but the tool must return to the position before executing in Manual mode when G74 is executed again,



otherwise the following path will be wrong.

- When the single block is running, programs dwell after each axial cutting cycle is completed.
- $R(\Delta d)$  must be omitted in blind hole cutting, and so there is no distance of tool retraction when the tool cuts to axial end point of cutting.

**Example:** Fig. 3-35

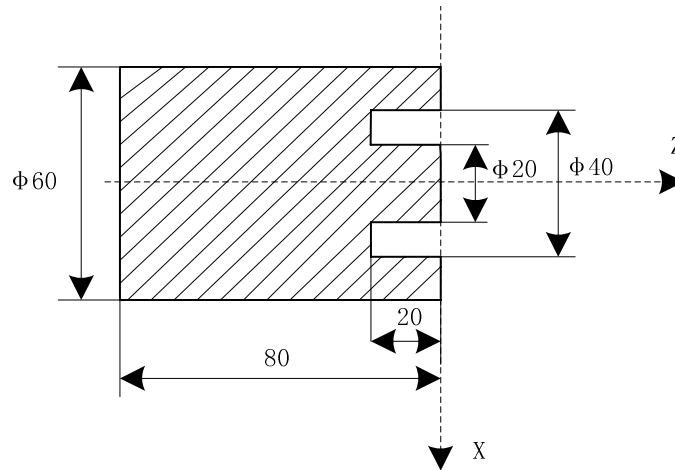

Fig.3-35

Program (suppose that the grooving tool width is 4mm, system least increment is 0.001mm):

O0007;

G0 X40 Z5 M3 S500; (Start spindle and position to starting point of machining)

G74 R0.5 ; (Machining cycle)

G74 X20 Z60 P3000 Q5000 F50; (Z tool infeed 5mm and tool retraction 0.5mm each time; rapid return to starting point (Z5) after cutting feed to end point (Z-20), X tool infeed 3mm and cycle the above-mentioned steps)

M30; (End of program)

### 3.20.6 Radial grooving multiple cycle G75

**Command format:** G75 R(e);

G75 X(U)\_\_ Z(W)\_\_ P( $\Delta i$ ) Q( $\Delta k$ ) R( $\Delta d$ ) F\_\_;

**Command function:** Axial (Z) tool infeed cycle compounds radial discontinuous cutting cycle:

Tool infeeds from starting point in radial direction, retracts, infeeds again, and again and again, and last tool retracts in axial direction, and retracts to position in radial direction, which is called one radial cutting cycle; tool infeeds in axial direction and execute the next radial cutting cycle; cut to end point of cutting, and then return to starting point (starting point and end point are the same one in G75), which is called one radial grooving compound cycle. Directions of axial tool infeed and radial tool infeed are defined by relative position between end point X(U) Z(W) and starting point of cutting. G75 is used for machining radial loop groove or column surface by radial discontinuously cutting, breaking stock and stock removal.

**Relevant definitions:**

**Starting point of radial cutting cycle:** Starting position of axial tool infeed for each radial cutting cycle, defined by  $A_n$  ( $n=1, 2, 3, \dots$ ), X coordinate of  $A_n$  is

the same that of starting point A, the different value of X coordinate between  $A_n$  and  $A_{n-1}$  is  $\Delta k$ . The starting point  $A_1$  of the first radial cutting cycle is the same as the starting point A, and Z starting point ( $A_f$ ) of the last axial cutting cycle is the same that of cutting end point.

**End point of radial tool infeed:** Starting position of radial tool infeed for each radial cutting cycle, defined by  $B_n$  ( $n=1, 2, 3, \dots$ ), X coordinates of  $B_n$  is the same that of cutting end point, Z coordinates of  $B_n$  is the same that of  $A_n$ , and the end point ( $B_f$ ) of the last radial tool infeed is the same that of cutting end point.

**End point of axial tool retraction:** End position of axial tool infeed (travel of tool infeed is  $\Delta d$ ) after each axial cutting cycle reaches the end point of axial tool infeed, defining with  $C_n$  ( $n=1, 2, 3, \dots$ ), X coordinate of  $C_n$  is the same that of cutting end point, and the different value of Z coordinate between  $C_n$  and  $A_n$  is  $\Delta d$ ;

**End point of radial cutting cycle:** End position of radial tool retraction from the end point of axial tool retraction, defined by  $D_n$  ( $n=1, 2, 3, \dots$ ), X coordinate of  $D_n$  is the same that of starting point, Z coordinates of  $D_n$  is the same that of  $C_n$  (the different value of Z coordinate between it and  $A_n$  is  $\Delta d$ );

**Cutting end point:** It is defined by  $X(U) \text{ --- } Z(W) \text{ ---}$ , and is defined with  $B_f$  of the last radial tool infeed.

**R(e):** It is the tool retraction clearance after each radial(X) tool infeed, its range is 0~99.999 (unit: mm, radius value) without sign symbols. The specified value is reserved validly after R(e) is executed and the data is switched and saved to No.056. NO.056 value is regarded as the tool retraction clearance when R(e) is not input.

**X:** X absolute coordinate value of cutting end point  $B_f$  (unit: mm).

**U:** Different value of X absolute coordinate between cutting end point  $B_f$  and starting point.

**Z:** Z absolute coordinate value of cutting end point  $B_f$  (unit:mm).

**W:** Different value of Z absolute coordinate between cutting end point  $B_f$  and starting point A(unit: mm).

**P( $\Delta i$ )** : Radial(X) discontinuous tool infeed of each axial cutting cycle, its range:  $0 < \Delta i \leq 9999999$  (IS\_B)/  $0 < \Delta k \leq 99999999$  (IS\_C) (unit: least input increment, without sign symbol).

**Q( $\Delta k$ )** : Axial(Z) discontinuous tool infeed of each radial cutting cycle, its range:  $0 < \Delta k \leq 9999999$ (IS\_B)/  $0 < \Delta k \leq 99999999$  (IS\_C) (unit: least input increment, without sign symbol)..

**R( $\Delta d$ )**: Axial (Z) tool retraction clearance after cutting to end point of radial cutting, its range:  $0 \sim 99999999 \times \text{least input increment}$ (unit: mm/inch, without sign symbol).

The system defaults the tool retraction clearance is 0 after the radial cutting end point is completed when R( $\Delta d$ ) is omitted.

The system defaults it executes the positive tool retraction when Z(W) and Q( $\Delta k$ ) are omitted.

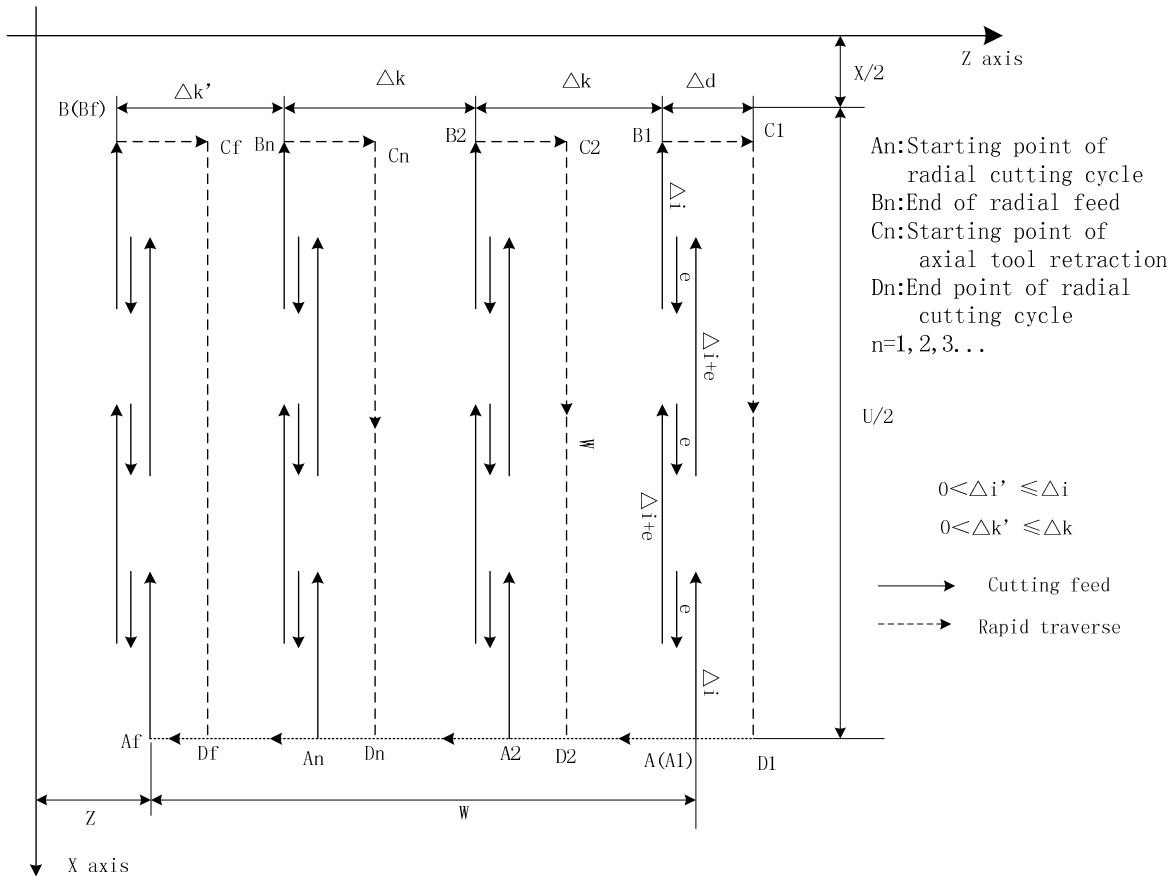

Fig. 3-36 G75 path

**Execution process:** (Fig. 3-36)

- ① Radial (X) cutting feed  $\Delta i$  from the starting point of radial cutting cycle, feed in X negative direction when the coordinates of cutting end point is less than that of starting point in X direction, otherwise, feed in X positive direction;
- ② Radial(X) rapid tool retraction  $e$  and its direction is opposite to the feed direction of ①;
- ③ X executes the cutting feed  $(\Delta k+e)$  again, the end point of cutting feed is still in it between starting point  $A_n$  of radial cutting cycle and end point of radial tool infeed, X executes the cutting feed  $(\Delta i+e)$  again and executes ②; after X cutting feed  $(\Delta i+e)$  is executed again, the end point of X cutting feed is on  $B_n$  or is not on it between  $A_n$  and  $B_n$  cutting feed to  $B_n$  and then execute ④;
- ④ Axial(Z) rapid tool retraction  $\Delta d$  to  $C_n$ , when Z coordinate of  $B_f$  (cutting end point) is less than that of A (starting point), retract tool in Z positive, otherwise, retract tool in Z negative direction;
- ⑤ Radial (Z) rapid retract tool to  $D_n$ , No. n radial cutting cycle is completed. The current radial cutting cycle is not the last one, execute ⑥; if it is the previous one before the last radial cutting cycle, execute ⑦;
- ⑥ Axial(X) rapid tool infeed, and its direction is opposite to ④ retract tool. If the end point of tool infeed is still on it between A and  $A_f$  (starting point of last radial cutting cycle) after Z tool infeed  $(\Delta d+\Delta k)$ , i.e.  $D_n \rightarrow A_{n+1}$  and then execute ① (start the next radial cutting cycle); if the end point of tool infeed is not on it between  $D_n$  and  $A_f$  after Z tool infeed  $(\Delta d+\Delta k)$ , rapidly traverse to  $A_f$  and execute ① to start the first radial cutting cycle;
- ⑦ Z rapidly traverses to A, and G75 is completed.

**Explanation:**

- The cycle movement is executed by X(W) and P( $\Delta$ i) blocks of G75, and the movement is not executed if only "G75 R(e);" block is executed;
- $\Delta$ d and e are specified by the same address R and whether there are X(U) and P( $\Delta$ i) words or not in blocks to distinguish them;
- The tool can stop in Auto mode and traverse in Manual mode when G75 is executed, but the tool must return to the position before executing in Manual mode when G75 is executed again, otherwise the following path will be wrong;
- When the system is executing the feed hold or single block, the program pauses after the system has executed end point of current path;
- R( $\Delta$ d) must be omitted in grooving, and so there is no tool retraction clearance when the tool cuts to radial cutting end point.

**Example:** Fig.3-37

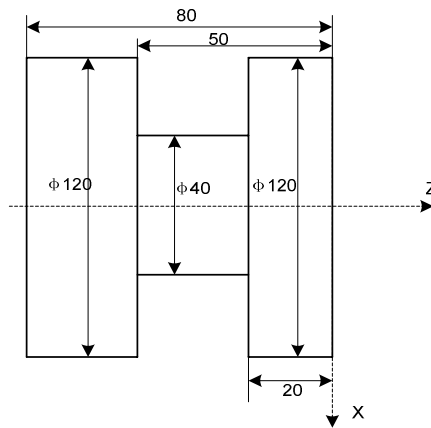

Fig. 3-37 G75 cutting

Program (suppose the grooving tool width is 4mm, the system least increment is 0.001mm):

```

O0008;
G00 X150 Z50 M3 S500;      (Start spindle with 500 r/min)
G0 X125 Z-20;              (Position to starting point of machining)
G75 R0.5 F150;             (Machining cycle)
G75 X40 Z-50 P6000 Q3000;  (X tool infeed 6mm every time, tool retraction 0.5mm,
                             rapid returning to starting point (X125) after infeeding
                             to end point (X40), Z tool infeed 3mm and cycle the
                             above-mentioned steps to continuously run programs)
G0 X150 Z50;              (Return to starting point of machining)
M30;                      (End of program)
    
```

### 3.21 Thread Cutting Commands

GSK980TDC CNC system can machine many kinds of thread cutting, including metric/inch single, multi threads, thread with variable lead and tapping cycle. Length and angle of thread run-out can be changed, multiple cycle thread is machined by single sided to protect tool and improve smooth finish of its surface. Thread cutting includes: continuous thread cutting G32, thread cutting with variable lead G34, Z thread cutting G33, Thread cutting cycle G92, Multiple thread cutting cycle G76.

The machine used for thread cutting must be installed with spindle encoder whose pulses are set by No.070m. Drive ratio between spindle and encoder is set by No.110 and No.111. X or Z traverses

to start machine after the system receives spindle signal per rev in thread cutting, and so one thread is machined by multiple roughing, finishing without changing spindle speed.

The system can machine many kinds of thread cutting, such as thread cutting without tool retraction groove. There is a big error in the thread pitch because there are the acceleration and the deceleration at the starting and ending of X and Z thread cutting, and so there is length of thread lead-in and distance of tool retraction at the actual starting and ending of thread cutting.

X, Z traverse speeds are defined by spindle speed instead of cutting feedrate override in thread cutting when the pitch is defined. The spindle override control is valid in thread cutting. When the spindle speed is changed, there is error in pitch caused by X and Z acceleration/deceleration, and so the spindle speed cannot be changed and the spindle cannot be stopped in thread cutting, which will cause tool and workpiece to be damaged.

### 3.21.1 Thread cutting with constant lead G32

**Command format:** G32 X(U)\_ Z(W)\_ F(I)\_ J\_ K\_ Q\_

**Command function:** The path of tool traversing is a straight line from starting point to end point as Fig.3-33; the longer moving distance from starting point to end point(X in radius value) is called as the long axis and another is called as the short axis. In course of motion, the long axis traverses one lead when the spindle rotates one revolution, and the short axis and the long axis execute the linear interpolation. Form one spiral grooving with variable lead on the surface of workpiece to realize thread cutting with constant lead. Metric pitch and inch pitch are defined respectively by F, I. Metric or inch straight, taper, end face thread and continuous multi-section thread can be machined in G32.

#### Command specifications:

G32 is modal;

Pitch is defined to moving distance when the spindle rotates one rev(X in radius);

Execute the straight thread cutting when X coordinates of starting point and end point are the same one(not input X or U);

Execute the end face thread cutting when X coordinates of starting point and end point are the same one(not input Z or W);

Execute the cutting taper thread when X and Z coordinates of starting point and end point are different;

#### Related definitions:

F: Metric pitch is moving distance of long axis when the spindle rotates one rev: 0.001 mm~500 mm. After F is executed, it is valid until F with specified pitch is executed again.

I: Teeth per inch. It is ones per inch(25.4 mm) in long axis, and also is circles of spindle rotation when the long axis traverses one inch(25.4 mm) :0.06tooth/inch~25400tooth/inch. After I is executed, it is valid until I with specified pitch is executed again. The metric, inch input both express the teeth per inch thread.

J: Movement in the short axis in thread run-out, its range:  $\pm 99999999 \times$  least input increment with negative sign; if the short axis is X, its value is specified with the radius; J value is the modal parameter.

K: Length in the long axis in thread run-out, its range:  $\pm 99999999 \times$  least input increment. If the long axis is X, its value is in radius without direction; K is modal parameter.

Q: Initial angle(offset angle)between spindle rotation one rev and starting point of thread cutting: 0~360000 (unit: 0.001 degree). Q is non-modal parameter, must be defined every time, otherwise it is 0°.

Q rules:

1. Its initial angle is  $0^\circ$  if Q is not specified;
2. For continuous thread cutting, Q specified by its following thread cutting block except for the first block is invalid, namely Q is omitted even if it is specified;
3. Multi threads formed by initial angle is not more than  $65535$ ;
4. Q unit :  $0.001^\circ$ . Q180000 is input in program if it offsets  $180^\circ$  with spindle one-turn; if Q180 or Q180.0, it is  $0.18^\circ$ .

Difference between long axis and short axis is shown in Fig. 3-38.

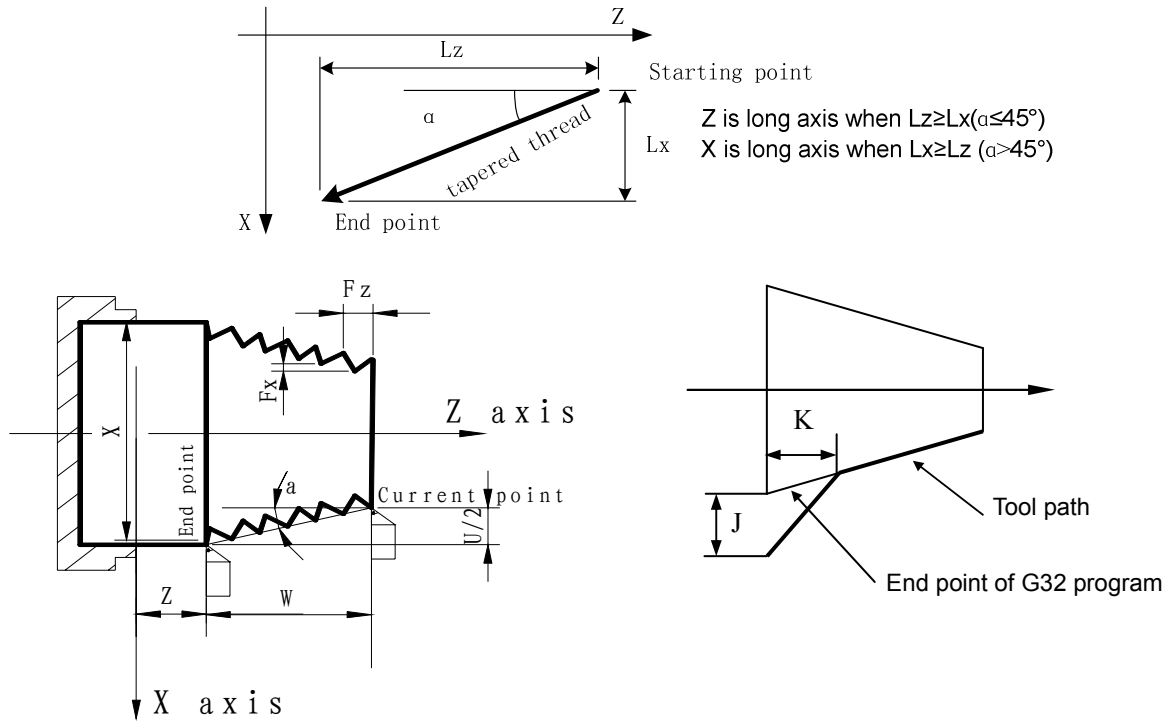

Fig. 3-38 G32 path

**Notes:**

- J, K are modal. The thread run-out is previous J, K value when they are omitted in the next block in continuous thread cutting. Their mode are cancelled when no thread cutting are executed;
- There is no thread run-out when J, or J, K are omitted;  $K=J$  is the thread run-out value when K is omitted;
- There is no thread run-out when  $J=0$  or  $J=0, K=0$ ;
- The thread run-out value  $J=K$  when  $J \neq 0, K=0$ ;
- There is no thread run-out when  $J=0$  or  $K \neq 0$ ;
- If the current block is for thread and the next block is the same, the system does not test the spindle encoder signal per rev at starting the next block to execute the direct thread cutting, which function is called as continuous thread machining;
- After the feed hold is executed, the system displays "Pause" and the thread cutting continuously executes not to stop until the current block is executed completely; if the continuous thread cutting is executed, the program run pauses after thread cutting blocks are executed completely;
- In Single block, the program stops run after the current block is executed. The program stops running after all blocks for thread cutting are executed;

- The thread cutting decelerates to stop when the system resets, emergently stop or its drive unit alarms.

**Example:** Pitch: 2mm.  $\delta_1 = 3\text{mm}$ ,  $\delta_2 = 2\text{mm}$ , total cutting depth 2mm divided into two times cut-in.

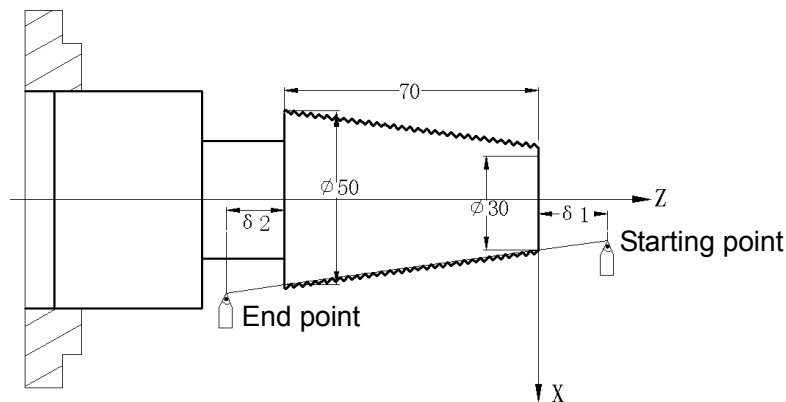

Fig.3-39

Program:

```

O0009;
G00 X28 Z3;           (First cut-in 1mm)
G32 X51 W-75 F2.0;   (First taper cutting)
G00 X55;             (Tool retraction)
W75;                 (Z returns to the starting point)
X27;                 (Second tool infeed 0.5mm)
G32 X50 W-75 F2.0;  (Second taper thread cutting )
G00 X55;             (Tool retraction)
W75 ;                (Z returns to the starting point)
M30;

```

### 3.21.2 Rigid thread cutting G32.1

**Command format:** G32.1 X(U)\_\_\_ Z(W)\_\_\_ C(H)\_\_\_ F(I)\_\_\_ S\_\_\_;

**Command function:** The traditional thread interpolation calculates the current distance of the movement of the feed axis based on the feedback pulse count of the position encoder installed on the spindle, which can realize the feed axis to follow the thread interpolation mode of the spindle. Its disadvantages are that there is a big error in the thread lead in acceleration/deceleration. In the rigid thread interpolation mode, the working of the spindle motor is the same that of the servo motor, and the interpolations between the feed axis and the spindle execute the thread interpolation to get the thread with high precision.

**Command explanation:**

G32.1 : rigid thread interpolation command;  
C : start angle of thread interpolation;  
(X,Z) : end point coordinates of thread interpolation;  
F (I) : thread lead, F (I) > 0 right-hand thread, F (I) < 0 left-hand thread;  
S : spindle speed;

Command path is shown below:

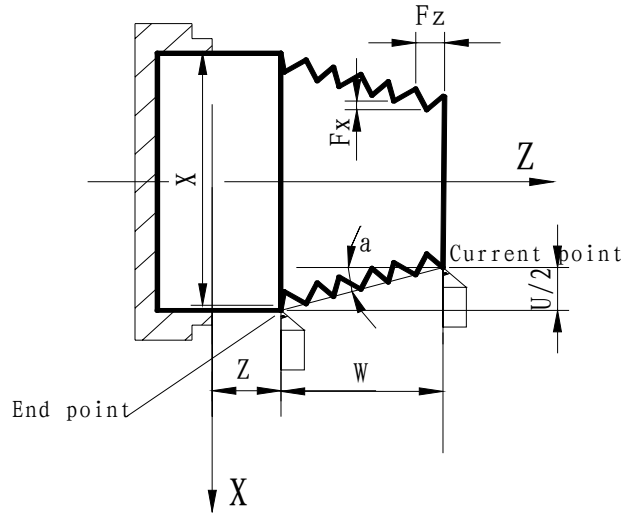

Fig. 3-40 G32.1 path

Explanations:

- 1) G32.1 is in Group 01;
- 2) When there is the C movement command in a block, the spindle firstly positions the start point of C axis before turning the thread;
- 3) Start points of X, Z, C axis must be the same one in the repetitive machining;
- 4) G32.1 cannot specify the thread run-out, and the feed axis and the spindle stops simultaneously at the end point of the thread;
- 5) The input range of the programmed address value in G32.1 is the same that of the general thread turning command (G32) ;
- 6) When G32.1 is executed, the pause signal is disabled temporarily and the spindle override is fixed to be 100%.

Notes:

- The spindle must be in the position control mode when it works;
- In multiple spindle control function, G32.1 is used only between the 1<sup>st</sup> spindle and the feed axis, and their uses and the related parameter settings are the same those of the rigid tapping;
- In G32.1, CNC does not check whether the current spindle is the position control mode or the speed control mode. So, the servo control axis of the 1<sup>st</sup> spindle is set to Cs working mode to avoid the coordinate overflow;
- Absolute coordinates of C axis are set to the cycle mode to avoid the coordinate overflow;
- The speed control mode is switched to the position control mode in the spindle control mode. Please execute that the spindle returns to the reference point or use G50 to set the start point of the current C axis;

Example: Supposing M14: the spindle is switched to the position control mode; M15: the spindle is switched to the speed control mode.

The thread is the right-hand, its lead is 2mm, the spindle speed is 500 r/m in thread cutting, thread cutting length is 20mm, and its programming format is shown below:

```
O0132 (0132);
G00 X100 Z100; //position to the safe position to change the tool
T0101; //change a thread tool (supposing No. 01 is the thread tool)
```



```

G00 X25 Z2; //position to the thread starting point (supposing the shape has been made at
            the last tool)
M14;       //switch the spindle from speed control mode to position control mode (it is 0°
            position after switch)
G50 C0;    // set the zero of the rotary axis(it is important to set it because the operation is
            relevant to the start angle of the following thread turning)
G32.1 Z-20 F2 S500 M08; //thread turning; the speeds of the spindle and the feed axis are 0 in
            end point
G00 X30;   //tool retraction
X24.5 Z2 C0; //return to thread starting point, and prepare for repetitively machining
G32.1 Z-20 F2 S500; // repetitively machine
....;     //repetitively machine
G00 X100;  //tool retraction
Z100;     //return to tool change position
M15;      //switch the spindle from position control mode to speed control mode
....;    //execution the 2nd machining procedure
....;
M30;     //end of program

```

### 3.21.3 Thread cutting with variable lead G34

**Command format:** G34 X(U)\_\_\_ Z(W)\_\_\_ F(I)\_\_\_ J\_\_\_ K\_\_\_ R\_\_\_ ;

**Command function:** The motion path of tool is a straight line from starting point of X, Z to end point specified by the block, the longer moving distance from starting point to end point(X in radius value) is called as the long axis and another is called as the short axis. In course of motion, the long axis traverses one lead when the spindle rotates one rev, the pitch increases or decreases a specified value per rev and one spiral grooving with variable lead on the surface of workpiece to realize thread cutting with variable lead. Tool retraction can be set in thread cutting.

F, I are specified separately to metric, inch pitch. Executing G34 can machine metric or inch straight, taper, end face thread with variable pitch.

**Command specifications:**

G34 is modal;

Meanings of X(U) , Z(W) , J, K are the same that of G32;

F: Specify lead, and its range is referred to Table 1-2;

I: Specify thread teeth per inch, and its range is referred to Table 1-2;

R: Increment or decrement of pitch per rev,  $R=F1- F2$ , with direction;  $F1>F2$ , pitch decreases when R is negative;  $F1<F2$ , pitch increases when R is positive (as Fig. 3-41);

R:  $\pm 0.001\sim\pm 500.000$  mm/pitch (metric thread);  
 $\pm 0.060\sim\pm 25400$  tooth/inch (inch thread).

The system alarms when R exceeds the above-mentioned range or the pitch exceeds permissive value or is negative owing to R increases or decreases.

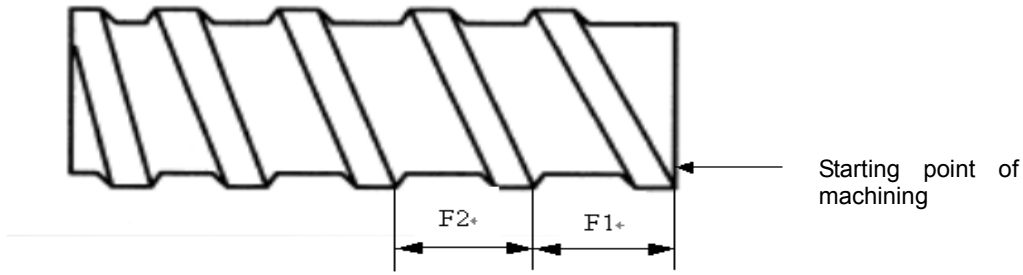

Fig. 3-41 Variable pitch thread

**Note:** It is the same as that of G32.

Example: First pitch of starting point: 4mm, increment 0.2mm per rev of spindle.

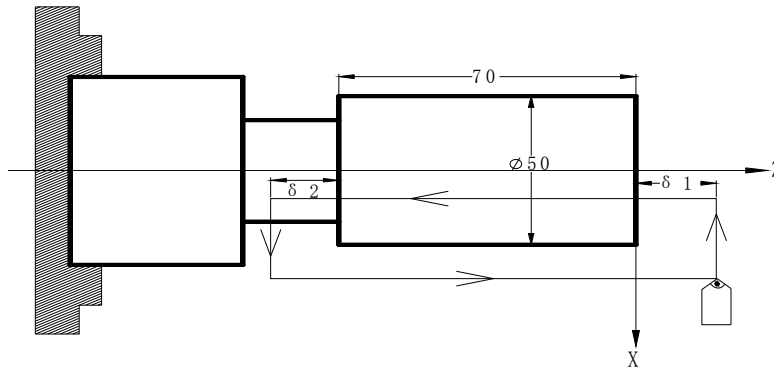

Fig. 3-42 Variable pitch thread machining

Use macro variables to simplify programming when G34 is used many times.  $\delta 1 = 4\text{mm}$ ,  $\delta 2 = 4\text{mm}$ , total cutting depth 4mm, total cutting cycle 15 times; first tool infeed 0.8mm, gradual decreasing cutting every time 0.2mm, min. infeed 0.2mm.

Program: O0010;

G00 X60 Z4 M03 S500;

G65 H01 P#102 Q800;

G65 H01 P#103 Q0;

N10 G65 H02 P#104 Q#103 R1;

G65 H01 P#103 Q#104;

G65 H81 P30 Q#104 R15;

G00 U-10;

G65 H01 P#100 Q#102;

G00 U-#100;

G34 W-78 F3.8 J5 K2 R0.2;

G00 U10;

Z4;

G65 H03 P#101 Q#100 R200;

G65 H01 P#102 Q#101;

G65 H86 P20 Q#102 R200;

G65 H80 P10;

N20 G65 H01 P#102 R200;

G65 H80 P10;

N30 M30;

First tool infeed: assignment #102=0.8mm

Cycle count: assignment #103=0

Cycle count starting: #104=#103+1

#103=#104

Total cutting cycle times: #104=15, jump to block N30

Tool infeed to  $\varnothing 50$

Cutting infeed: #100=#102

Tool infeed

Variable pitch cutting

Tool retraction

Z returns to starting point

Decreasing of cutting feed again: #101=#100-0.2

Assignment again #102=#101

Infeed: Jump to block N20 when #102  $\leq$  0.2mm

Unconditionally jump to block N10

Min. infeed: #102=0.2

Unconditionally jump to block N10

### 3.21.4 Z thread cutting G33

**Command format:** G33 Z(W)\_\_\_ F(I)\_\_\_ L\_\_\_ ;

**Command function:** Tool path is from starting point to end point and then from end point to starting point. The tool traverses one pitch when the spindle rotates one rev, the pitch is consistent with pitch of tool and there is spiral grooving in internal hole of workpiece and the internal machining can be completed one time.

**Command specification:** G33 is modal command;

Z(W): When Z or W is not input and starting point and end point of Z axis are the same one, the thread cutting must not be executed;

F: Thread pitch, and its range is referred to Table 1-2;

I: Teeth per inch thread 0.06~25400 teeth/inch; its range is referred to Table 1-2. It is single thread when L is omitted.

**Cycle process:**

- ① Z tool infeed (start spindle before G33 is executed);
- ② M05 signal outputs after Z reaches the specified end point in programming;
- ③ Test spindle after completely stopping;
- ④ Spindle rotation (CCW) signal outputs(reverse to the original rotation direction);
- ⑤ Z executes the tool retracts to starting point;
- ⑥ M05 signal outputs and the spindle stops;
- ⑦ Repeat the steps ①~⑤ if multi threads are machined.

**Example:** Fig. 3-89, thread M10×1.5

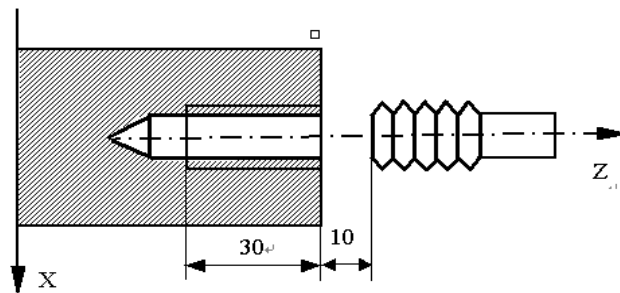

Fig. 3-89

Program:

```

O0011;
G00 Z90 X0 M03;      Start spindle
G33 Z50 F1.5;        Tap cycle
M03                  Start spindle again
G00 X60 Z100;        Machine continuously
M30

```

**Note 1:** Before tapping, define rotation direction of spindle according to tool rotating. The spindle stops rotation after the tapping is completed and the spindle is started again when machining thread continuously.

**Note 2:** G33 is for rigid tapping. The spindle decelerates to stop after its stop signal is valid, at the moment, Z executes continuously infeeds along with the spindle rotating, and so the actual cutting bottom hole is deeper than requirement and the length is defined by the spindle speed and its brake in tapping.

**Note 3:** Z rapid traverse speed in tapping is defined by spindle speed and pitch is not relevant to cutting feedrate override.

**Note 4:** In Single block to feed hold, the tapping cycle continuously executes not to stop until the tool returns to starting point when the system displays "Pause".

Note 5: The thread cutting decelerates to stop when the system resets, emergently stop or its driver alarms.

### 3.21.5 Rigid tapping G84, G88

**Command format:** End face rigid tapping G84 X(U)\_\_\_ C(H)\_\_\_ Z(W)\_\_\_ P\_\_\_ F(I)\_\_\_ K\_\_\_ M\_\_\_;  
 Side rigid tapping G88 Z(W)\_\_\_ C(H)\_\_\_ X(U)\_\_\_ P\_\_\_ F(I)\_\_\_ K\_\_\_ M\_\_\_;

Command explanations: modal G codes

G84: End face tapping cycle G code

G88: Side tapping cycle G code

(X, C): Tapping hole position; -----G84

Z: Hole bottom position of tapping; -----G84

(Z, C): Tapping hole position; -----G88

X: Hole bottom position of tapping hole; -----G88

P: Pause time (ms) when tapping to the hole bottom

F(I): Thread lead, F (I) > 0 right-hand tapping, F (I) < 0 left-hand tapping

K: Repetitive count of tapping. When the incremental programming is used to the tapping hole position, the tapping is performed in the different hole position

M: Used to clamp the graduation spindle.

**Rigid tapping method:**

- M29 S\_ before G84/G88 is specified below  
 M29 S\_;  
 G84(G88) X\_C\_(Z\_C\_) Z\_(X\_) P\_ F\_ K\_ M\_;
- M29 S\_ in the same block is commanded below  
 G84(G88) X\_C\_(Z\_C\_) Z\_(X\_) R\_ P\_ F\_ K\_ M29 S\_;

**Notes :**

- 1) For the above 2<sup>nd</sup> method, the machine zero return is executed before the spindle executes the tapping, otherwise, the method cannot be used. In M29, CNC cannot select a spindle to execute the tapping. The rigid tapping needs to be clamped when the spindle positioning is completed, the method also cannot be used because M codes cannot be in the same block;
- 2) The axis movement command cannot be use between M29 and G84/G88;
- 3) M29 cannot be specified repetitively in rigid tapping;
- 4) In multiple spindle rigiding tapping, a spindle used to the rigid tapping must be selected before M29, and it cannot be switched before the rigid tapping state is cancelled;

Operations is shown below:

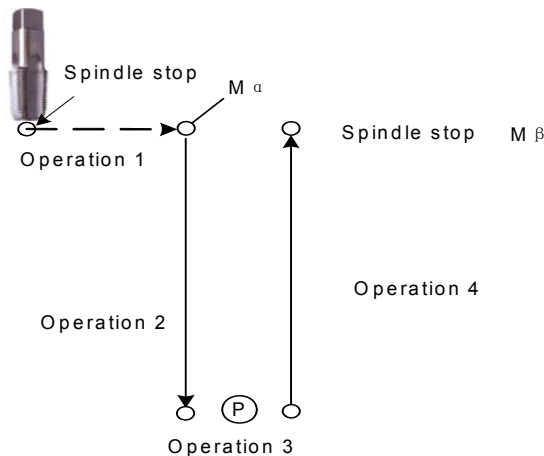

**Execution explanations:**

- Operation 1: positioning to the hole position (starting point of rigid tapping);
- Before starting operation 2, the system outputs M $\alpha$  when it has M code used to clamp the spindle;
- Operation 2: start the rigid tapping;
- Operation 3: pause time P in rigid tapping in hole bottom;
- Operation 4: the rigid tapping returns to the hole bottom (starting point of rigid tapping);
- When the block for rigid tapping specifies M code used to clamp the spindle, M $\beta$  is output.

**Note:**  $\alpha$  value is set in №170,  $\beta = \alpha + 1$ , so, these corresponding M codes in PLC are executed.

**Rigid tapping sequence**

Taking example of G84 right-hand tapping, explain the creation, execution and cancellation of rigid tapping.

Creation and execution of rigid tapping

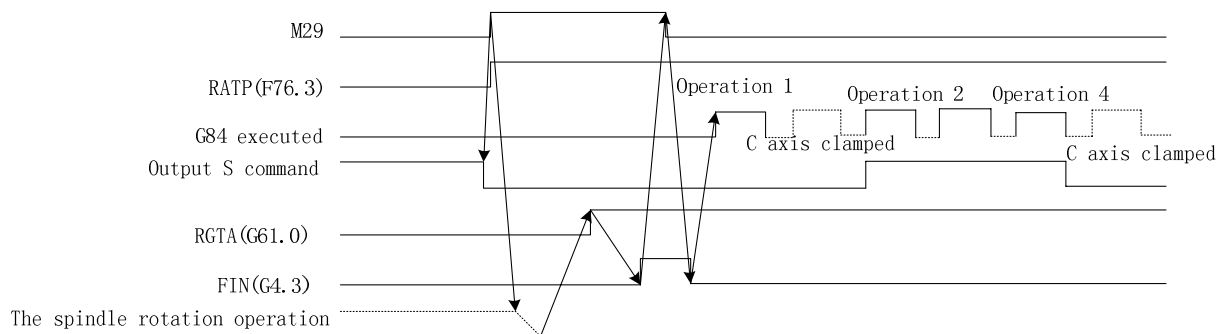

The spindle rotation operation is defined that the rotary axis is switched to the position control mode (i.e. send the position mode switch signal to the servo spindle), and the system checks the position mode arrival signal of the servo spindle.

**Rigid tapping cancellation**

The cancellation methods of rigid tapping are shown below:

- 1) G80 cancels the rigid tapping mode;
- 2) G codes commands other cycles;
- 3) Other G codes in Group 01;
- 4) CNC resets.

The falling edge of F76.3 signal cancels the rigid tapping mode signal.

(a) RTCRG(№186 #2) is set to '1' when:

The system executes directly the next block instead of waiting the rigid tapping mode signal RGTAP<G61 #0> to become '0'.

Rigid tapping cancellation is shown below:

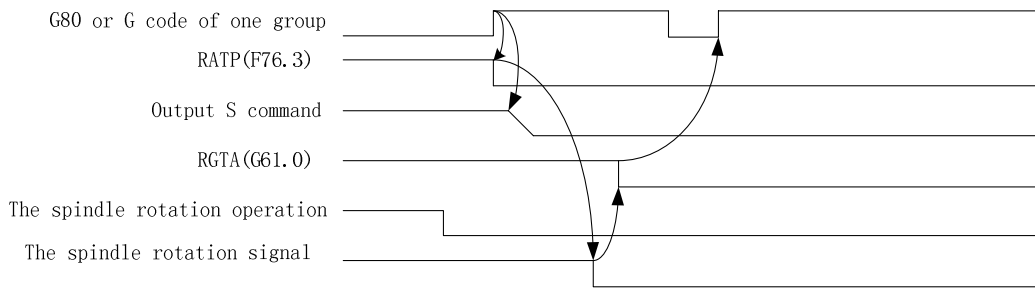

(b) RTCRG(N#186 # 2) is set to '0' when:

Wait the rigid tapping mode signal RGTAP<G61 # 0> to become '0' and then execute the next block. Rigid tapping cancellation is shown below:

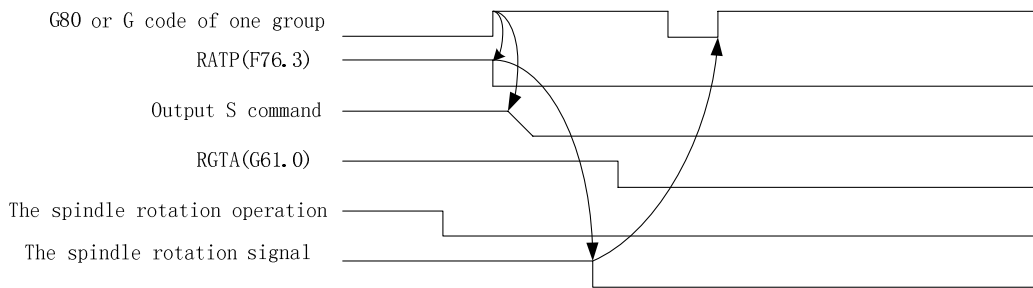

**Notes:**

- In rigid tapping, when the tapping direction is changed (i.e. G84 and G88 are switched), the system specifies again the hole bottom position of the tapping, otherwise, the unexpected result rises;
- The rigid tapping G command is in Group 01, it is cancelled temporarily in the rigid tapping state, and then is recovered it after the tapping is done;
- The dry run function is disabled in rigid tapping;
- In the rigid tapping, the machine lock function is valid; the tapping axis and the spindle do not move when the machine lock function is enabled;
- When the reset is executed in the rigid tapping, the rigid tapping state is released and the spindle returns to the previous state before the rigid tapping;
- In rigid tapping, when the tapping block is executed and the tapping returns, the feed hold/single block run function is disabled temporarily till the tapping return completes;
- In rigid tapping mode, the backlash compensation is performed to compensate the dry run of the spindle rotation(CW, CCW). It is set in parameters (N#33~N#34 or N#180~N#182). The backlash compensation along the tapping axis is performed in general method;
- In multiple spindle tapping, the 1<sup>st</sup> spindle is used to the graduation and the 2<sup>nd</sup> to the tapping. After the 1<sup>st</sup> spindle graduation is completed, the spindle must be clamped on the machine and the machine clamping/releasing M code can be specified in the rigid tapping. M code used to clamp the spindle is added in G84/G88, i.e. the system can output two kinds of M code. M code used to clamp the spindle is set in the data parameter (N#170). M code used to the releasing is the setting value +1 of N#170;
- Setting RTORI (state parameter N#186 # 7) to 1 can execute the reference point return of the spindle before the system starts the rigid tapping.

### 3.21.6 Thread cutting cycle G92

**Command format:** G92 X(U) \_ Z(W) \_ F\_ J\_ K\_ L\_; (Metric straight thread cutting cycle)  
 G92 X(U) \_ Z(W) \_ I\_ J\_ K\_ L\_; (Inch straight thread cutting cycle)  
 G92 X(U) \_ Z(W) \_ R\_ F\_ J\_ K\_ L\_; (Metric taper thread cutting cycle)  
 G92 X(U) \_ Z(W) \_ R\_ I\_ J\_ K\_ L\_; (Metric taper thread cutting cycle)

**Command function:** Tool infeeds in radial(X) direction and cuts in axial(Z or X, Z) direction from starting point of cutting to realize straight thread, taper thread cutting cycle with constant thread pitch. Thread run-out in G92: at the fixed distance from end point of thread cutting, Z executes thread interpolation and X retracts with exponential or linear acceleration, and X retracts at rapidly traverse speed after Z reaches to end point of cutting as Fig. 3-44.

**Command specifications:**

G92 is modal;

Starting point of cutting: starting position of thread interpolation;

End point of cutting: end position of thread interpolation;

X: X absolute coordinate of end point of cutting, unit: mm;

U: different value of X absolute coordinate from end point to starting point of cutting, unit: mm;

Z: Z absolute coordinate of end point of cutting, unit: mm;

W: Different value of X absolute coordinate from end point to starting point of cutting, unit: mm;

R: Different value(radius value) of X absolute coordinate from end point to starting point of cutting.

When the sign of R is not the same that of U,  $R \leq |U/2|$ , unit: mm;

F: Thread lead, its range:  $0 < F \leq 500$  mm. After F value is executed, it is reserved and can be omitted;

I: Thread teeth per inch, its range:  $0.06\text{tooth/inch} \sim 25400\text{tooth/inch}$ , it is reserved and it can be omitted not to input after I specified value is executed;

J: Movement in the short axis in thread run-out, its range  $0 \sim 99999999 \times$  least input increment, unit: mm/inch, without direction ( automatically define its direction according to starting position of program), and it is modal parameter. If the short axis is X, its value is specified by radius;

K: Movement in the long axis in thread run-out, its range:  $0 \sim 99999999 \times$  least input increment, unit: mm/inch, without direction ( automatically define its direction according to starting position of program), and it is modal parameter. If the long axis is X, its value is specified by radius;

L: Multi threads:  $1 \sim 99$  and it is modal parameter. (The system defaults it is single thread when L is omitted).

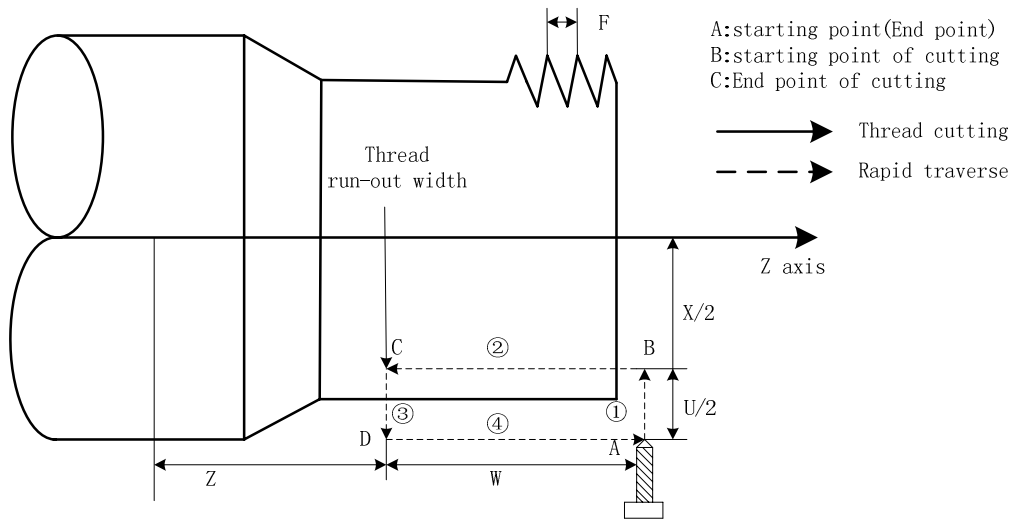

Fig. 3-44

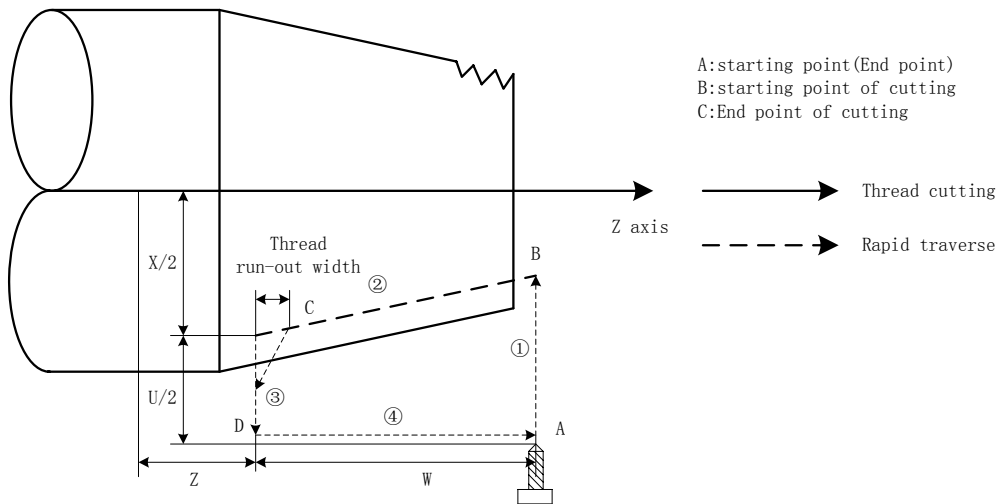

Fig. 3-45

The system can machine one thread with many tool infeed in G92, but cannot do continuous two thread and end face thread. Definition of thread pitch in G92 is the same that of G32, and a pitch is defined that it is a moving distance of long axis(X in radius) when the spindle rotates one rev.

Pitch of taper thread is defined that it is a moving distance of long axis(X in radius). When absolute value of Z coordinate difference between B point and C point is more than that of X (in radius), Z is long axis; and vice versa.

Cycle process: straight thread as Fig.3-44 and taper thread as Fig.3-45.

- ① X traverses from starting point to cutting starting point;
- ② Thread interpolates (linear interpolation) from the cutting starting point to cutting end point;
- ③ X retracts the tool at the cutting feedrate (opposite direction to the above-mentioned ①), and return to the position which X absolute coordinate and the starting point are the same;
- ④ Z rapidly traverses to return to the starting point and the cycle is completed.



**Notes:**

- Length of thread run-out is specified by N#019 when J, K are omitted;
- Length of thread run-out is K in the long direction and is specified by N#019 when J is omitted;
- Length of thread run-out is J=K when K is omitted;
- There is no thread run-out when J=0 or J=0, K=0;
- Length of thread run-out is J=K when J≠0, K=0;
- There is no thread run-out when J=0, K≠0;
- After executing the feed hold in thread cutting, the system does not stop cutting until the thread cutting is completed with **Pause** on screen;
- After executing single block in thread cutting, the program run stops after the system returns to starting point(one thread cutting cycle is completed);
- They are executed as the positive values when J, K negative values are input;
- Thread cutting decelerates to stop when the system resets, emergently stops or its driver alarms.

**Command path:** relative position between thread cutting end point and starting point with U, W, R and tool path and thread run-out direction with different U, W, R signs below:

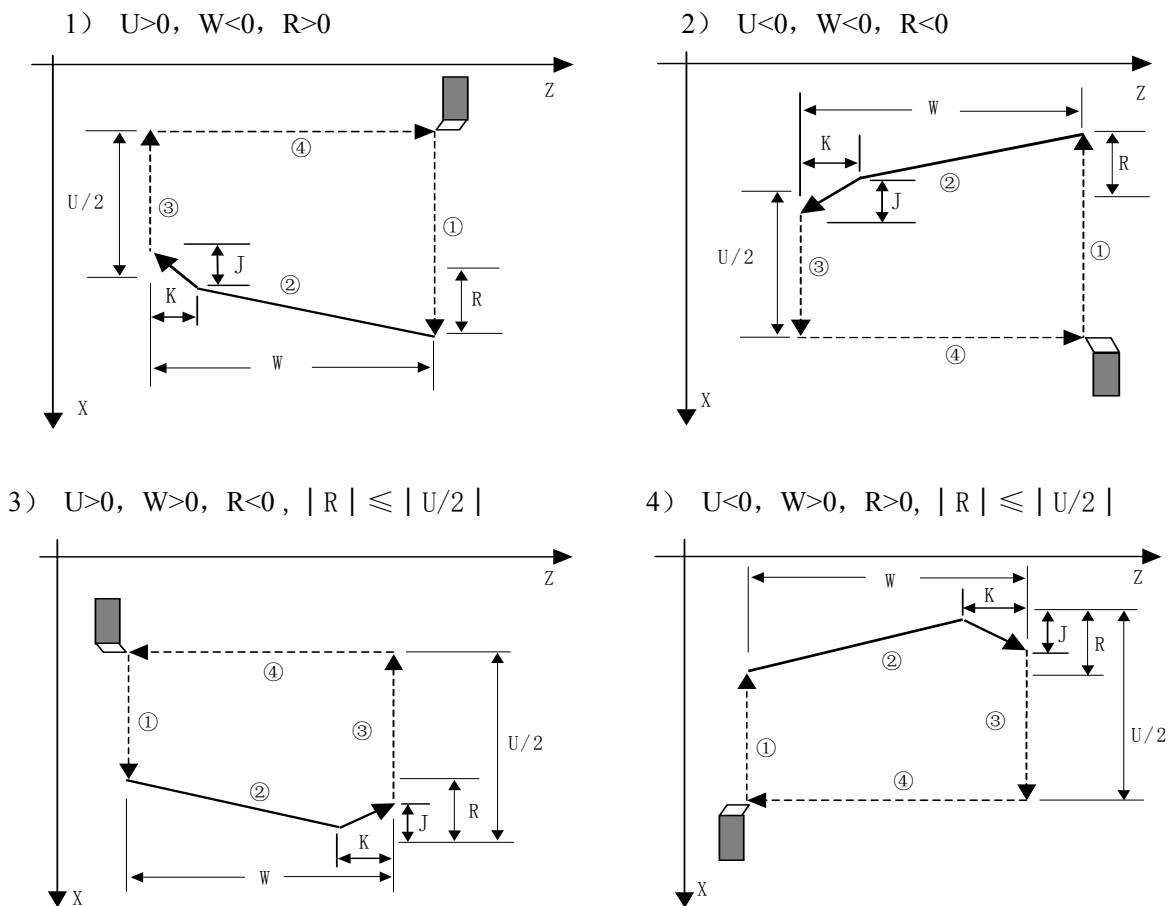

Fig.3-46

Example: Fig.3-47

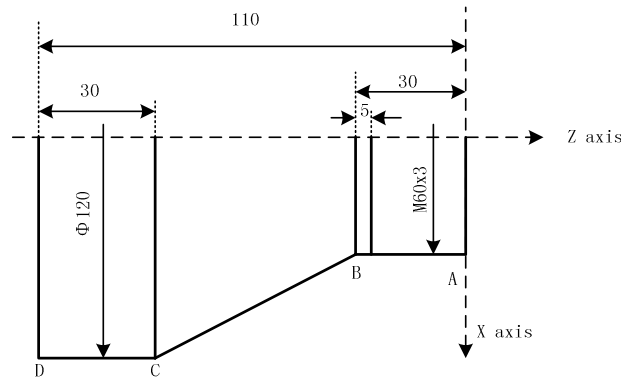

Fig.3-47

Program:

```
O0012;
M3 S300 G0 X150 Z50 T0101; (Thread tool)
G0 X65 Z5; (Rapid traverse)
G92 X58.7 Z-28 F3 J3 K1; (Machine thread with 4 times cutting, the first tool infeed 1.3mm)
X57.7 ; (The second tool infeed 1mm)
X57; (The third tool infeed 0.7mm)
X56.9; (The fourth tool infeed 0.1mm)
M30;
```

### 3.21.7 Multiple thread cutting cycle G76

**Command format:** G76 P(m) (r) (a) Q( $\Delta$ dmin) R(d);  
G76 X(U) \_\_ Z(W) \_\_ R(i) P(k) Q( $\Delta$ d) F(l) \_\_;

**Command function:** Machining thread with specified depth of thread (total cutting depth) is completed by multiple roughing and finishing, if the defined angle of thread is not 0°, thread run-in path of roughing is from its top to bottom, and angle of neighboring thread teeth is the defined angle of thread. G76 can be used for machining the straight and taper thread with thread run-out path, which is contributed to thread cutting with single tool edge to reduce the wear of tool and to improve the precision of machining thread. But G76 cannot be used for machining the face thread. machining path is shown in Fig. 3-48(a):

**Relevant definitions:**

**Starting point(end point):** Position before block runs and behind blocks run, defined by A point;

**End point of thread(D point):** End point of thread cutting defined by X(U) \_\_ Z(W) \_\_.The tool will not reach the point in cutting if there is the thread run-out path;

**Starting point of thread:** Its absolute coordinates is the same that of A point and the different value of X absolute coordinates between C and D is i(thread taper with radius value). The tool cannot reach C point in cutting when the defined angle of thread is not 0°;

**Reference point of thread cutting depth (B point) :** Its absolute coordinates is the same that of A point and the different value of X absolute coordinate between B and C is k(thread taper with radius value).The cutting depth of thread at B point is 0 which is the reference point used for counting each thread cutting depth by the system;

**Thread cutting depth:** It is the cutting depth for each thread cutting cycle. It is the different value

(radius value, without signs) of X absolute coordinate between B and intersection of reversal extension line for each thread cutting path and straight line BC. The cutting depth for each roughing is  $\sqrt{n} \times \Delta d$ , n is the current roughing cycle times,  $\Delta d$  is the thread cutting depth of first roughing;

**Thread cutting amount:** Different value between the current thread current depth and the previous one:  $(\sqrt{n} - \sqrt{n-1}) \times \Delta d$ ;

**End point of tool retraction:** It is the end position of radial (X) tool retraction after the thread cutting in each thread roughing, finishing cycle is completed, defining with E point;

**Thread cut-in point:**  $B_n$  (n is the cutting cycle times) is the actual thread cutting starting point in each thread roughing cycle and finishing cycle,  $B_1$  is the first thread roughing cutting-in point,  $B_f$  is the last thread roughing cut-in point,  $B_e$  is the thread finishing cutting-in point.  $B_n$  is X, Z replacement formula corresponding to B.

$$t g \frac{a}{2} = \frac{Z \text{ replacement}}{X \text{ replacement}}$$

a: thread angle;

**X:** X absolute coordinate (unit: mm) of thread end point;

**U:** Different value (unit: mm) of X absolute coordinate between thread end point and starting point;

**Z:** Z absolute coordinate (unit: mm) of thread end point;

**W:** Different value (unit: mm) of Z absolute coordinate between thread end point and starting point;

**P(m):** Times of thread finishing: 00~99 (unit: times). It is valid after m specified value is executed, and the system parameter №057 value is rewritten to m. The value of system parameter №057 is regarded as finishing times when m is not input. In thread finishing, every feed cutting amount is equal to the cutting amount d in thread finishing dividing the finishing times m;

**P(r):** Width of thread run-out 00~99(unit:  $0.1 \times L$ , L is the thread pitch). It is valid after r specified value is executed and the system parameter №019 value is rewritten to r. The value of system parameter №019 is the width of thread run-out when r is not input. The thread run-out function can be applied to thread machining without tool retraction groove and the width of thread run-out defined by system parameter №019 is valid for G92, G76;

**P(a):** Angles at taper of neighboring two tooth, range: 00~99, unit: deg(°). It is valid after a specified value is executed and the system parameter №058 value is rewritten to a. The system parameter №058 value is regarded as angle of thread tooth. The actual angle of thread in defined by tool ones and so a should be the same as the tool angle;

$\Delta Q(\Delta d_{min})$ : Minimum cutting travel of thread roughing, range: 0 ~ 999999( IS-C)/ 0 ~ 99999( IS-B),(unit: least input increment, radius value). When  $(\sqrt{n} - \sqrt{n-1}) \times \Delta d < \Delta d_{min}$ ,  $\Delta d_{min}$  is regarded as the cutting travel of current roughing, i.e. depth of current thread cutting is  $(\sqrt{n-1} \times \Delta d + \Delta d_{min})$ . Setting  $\Delta d_{min}$  is to avoid the too small of roughing amount and too many roughing times caused by the cutting amount deceleration in thread roughing. After  $Q(\Delta d_{min})$  is executed, the specified value  $\Delta d_{min}$  is valid and the system data parameter NO. 059 value is rewritten to  $\Delta d_{min}$  (unit: 0.001). when  $Q(\Delta d_{min})$  is not input, the system data parameter NO.059 value is taken as the least cutting amount;

**R(d):** It is the cutting amount in thread finishing, range: 00~99.999 (unit: mm/inch, radius value without sign symbols), the radius value is equal to X absolute coordinates between cut-in point  $B_e$  of thread finishing and  $B_f$  of thread roughing. After R(d) is executed, the specified value d is reserved and the system parameter №060 value is rewritten to  $d \times 1000$ (unit: 0.001 mm). The value of system parameter №060 is regarded as the cutting travel of thread finishing when R(d) is not input;

- R(i):** It is thread taper and is the different value of X absolute coordinate between thread starting point and end point, rang: -99999.999~99999.999(IS\_B) /-9999.9999~9999.9999(IS\_C) (unit: mm/inch, radius value). The system defaults R(i)=0(straight thread) when R(i) is not input;
- P(k):** Depth of thread tooth, the total cutting depth of thread, range: 1~99999999(unit: least input increment, radius value, without sign symbols). The system alarms when P(k) is not input;
- Q( $\Delta d$ ):** Depth of the 1<sup>st</sup> thread cutting, range: 1~99999999 unit: least input increment, radius value, without sign symbols). The system alarms when  $\Delta d$  is not input;
- F:** metric thread pitch, its range is referred to Table 1-2;
- I:** thread teeth per inch for inch thread, its range is referred to Table 1-2.
- J:** movement amount (run-out amount) (unit: mm/inch, without direction) in the short axis when thread run-out; when the short axis is X, its value is designated by radius and is simple parameter;
- K:** movement amount (run-out amount) (unit: mm/inch, without direction) in the long axis when thread run-out; when the long axis is X, its value is designated by radius and is simple parameter.

**Note:** J, K are not compiled in G76, its thread run-out method is the same that of the previous, i.e. the thread run-out is executed according to P® or No.19; when J or K, or J, K are compiled, the thread run-out method is the same those of G32, G92.

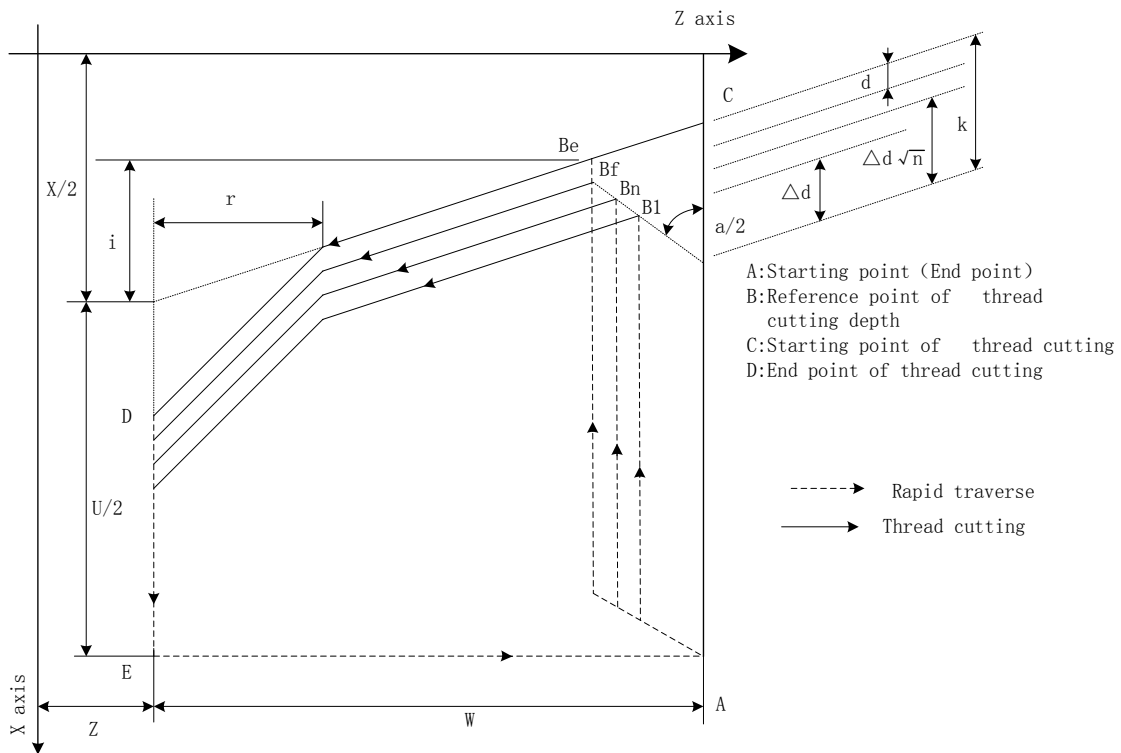

Fig. 3-48(a)

Cut-in method as follows: Fig. 3-48(b):

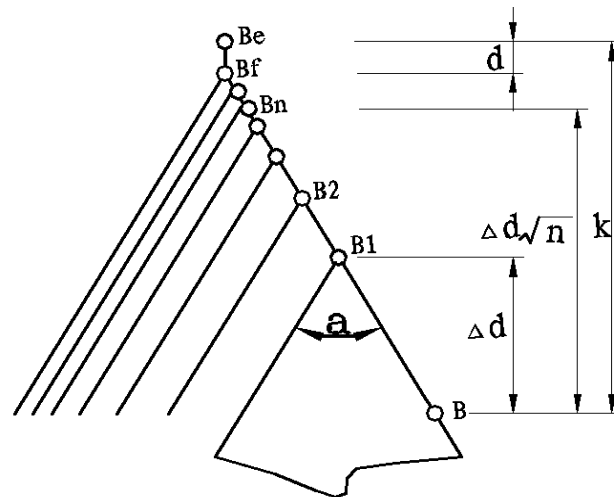

Fig. 3-48(b)

Pitch is defined to moving distance ( X radius value) of long axis when the spindle rotates one rev. Z is long when absolute value of coordinate difference between C point and D point in Z direction is more than that of X direction ( radius value, be equal to absolute value of i); and vice versa

#### Execution process:

- ① The tool rapidly traverses to  $B_1$ , and the thread cutting depth is  $\Delta d$ . The tool only traverses in X direction when  $a=0$ ; the tool traverses in X and Z direction and its direction is the same that of  $A \rightarrow D$  when  $a \neq 0$ ;
- ② The tool cuts threads paralleling with  $C \rightarrow D$  to the intersection of  $D \rightarrow E$  ( $r \neq 0$ : thread run-out);
- ③ The tool rapidly traverses to E point in X direction;
- ④ The tool rapidly traverses to A point in Z direction and the single roughing cycle is completed;
- ⑤ The tool rapidly traverses again to tool infeed to  $B_n$  ( is the roughing times), the cutting depth is the bigger value of  $(\sqrt{n} \times \Delta d)$ ,  $(\sqrt{n-1} \times \Delta d + \Delta d_{min})$ , and execute ② if the cutting depth is less than  $(k-d)$ ; if the cutting depth is more than or equal to  $(k-d)$ , the tool infeeds  $(k-d)$  to  $B_f$ , and then execute ⑥ to complete the last thread roughing;
- ⑥ The tool cuts threads paralleling with  $C \rightarrow D$  to the intersection of  $D \rightarrow E$  ( $r \neq 0$ : thread run-out);
- ⑦ X axis rapidly traverses to E point;
- ⑧ Z axis traverses to A point and the thread roughing cycle is completed to execute the finishing;
- ⑨ After the tool rapidly traverses to B (the cutting depth is  $k$  and the cutting travel is  $d$ ), execute the thread finishing, at last the tool returns to A point and so the thread finishing cycle is completed;
- ⑩ If the finishing cycle time is less than  $m$ , execute ⑨ to perform the finishing cycle, the thread cutting depth is  $k$  and the cutting travel is 0; if the finishing cycle times are equal to  $m$ , G76 compound thread machining cycle is completed.

#### Notes:

- In thread cutting, execute the feed hold, the system displays **Pause** after the thread cutting is executed completely, and then the program run pauses;
- Execute single block in thread cutting, the program run stops after returning to starting point (one thread cutting cycle is completed);

- The thread cutting decelerates to stop when the system resets and emergently stop or the driver alarms;
- Omit all or some of G76 P(m) (r) (a) Q( $\Delta d_{min}$ ) R(d). The omitted address runs according to setting value of parameters;
- m, r, a used for one command address P are input one time. Program runs according to setting value of №57, 19, 58 when m, r, a are all omitted; Setting value is a when address P is input with 1 or 2 digits; setting values are r, a when address P is input with 3 or 4 digits;
- The direction of A→C→D→E is defined by signs of U,W, and the direction of C→D is defined by the sign of R(i). There are four kinds of sign composition of U, W corresponding to four kinds of machining path as Fig. 3-46.

Example: Fig. 3-49, thread M68×6.

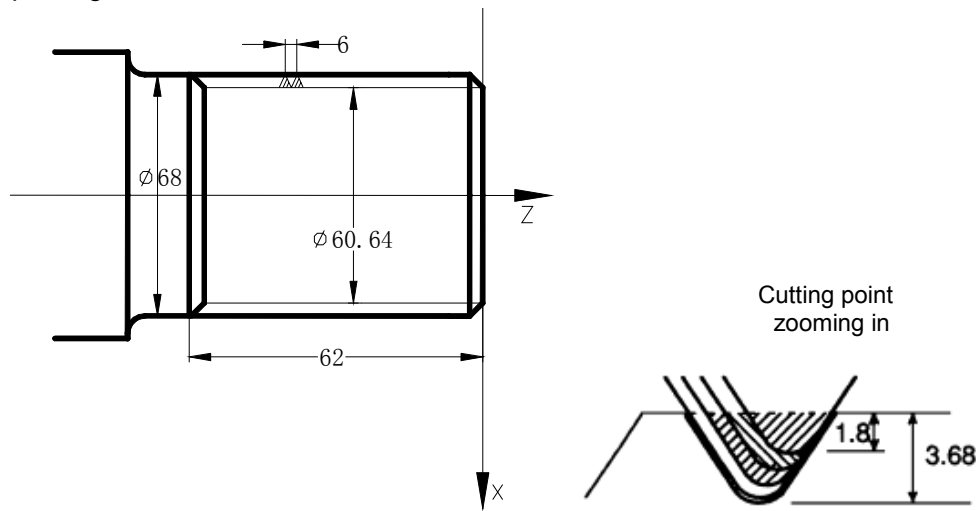

Fig.3-49

Program:

O0013;	
G50 X100 Z50 M3 S300;	(Set workpiece coordinate system, start spindle and specify spindle speed)
G00 X80 Z10;	(Rapid traverse to starting point of machining)
G76 P020560 Q150 R0.1;	(Finishing 2 times, chamfering width 0.5mm, tool angle 60°, min. cutting depth 0.15, finishing allowance 0.1)
G76 X60.64 Z-62 P3680 Q1800 F6;	(Tooth height 3.68, the first cutting depth 1.8)
G00 X100 Z50 ;	(Return to starting point of program)
M30;	(End of program)

### 3.22 Constant Surface Speed Control G96, Constant Rotational Speed Control G97

The detailed is referred to Section 2.2.3.

### 3.23 Feedrate per Minute G98, Feedrate per Rev G99

**Command format:** G98 F\_; (its range is referred to Section 1.6.5, the leading zero can be omitted, feed rate per minute is specified, mm/min)

**Command function:** cutting feed rate is specified as mm/min, G98 is the modal G command. G98 cannot be input if the current command is G98 modal.

**Command format:** G99 F\_; (its range is referred to Section 1.6.5, the leading zero can be omitted)

**Command function:** Cutting feed rate is specified as mm/min, G99 is the modal G command. G99 input may be omitted if current state is G99. The actual cutting feedrate is gotten by multiplying the F command value (mm/r) to the current spindle speed(r/min). If the spindle speed varies, the actual feedrate changes too. If the spindle cutting feed amount per rev is specified by G99 FXXXX , the even cutting texture on the surface of workpiece will be gotten. In G99 state, a spindle encoder should be fixed on the machine tool to machine the workpiece.

G98, G99 are the modal G commands in the same group and only one is valid. G98 is the initial state G command and the system defaults G98 is valid when the system turns on.

Reduction formula of feed between per rev and per min:

$$F_m = F_r \times S$$

$F_m$ : feed per min (mm/min) ;

$F_r$ : feed per rev (mm/r) ;

$S$ : spindle speed (r/min) .

After the system turns on, the feedrate is ones set by No030 and F value is reserved after F is executed. The feed rate is 0 after F0 is executed. F value is reserved when the system resets and emergently stops. The feedrate override is reserved when the system is turned off.

**Note:** In G99 modal, there is the uneven cutting feed rate when the spindle speed is lower than 1 r/min; there is the follow error in the actual cutting feed rate when there is the swing in the spindle speed. To gain the high machining quality, it is recommended that the selected spindle speed should be not lower than min. speed of spindle servo or converter.

**Cutting feed:** The system can control the motions in X, Z direction contributed that the motion path of tool and the defined path by commands (line straight, arc ) is consistent, and also instantaneous speed on the tangent of motion path and F word is consistent, which motion control is called cutting feed or interpolation. The cutting feedrate is specified by F, the system divides the cutting feedrate specified by F according to the programming path into vector in X, Z direction, also controls the instantaneous speed in X, Z direction to contribute that the combined speed of vector in X, Z direction is equal to F command value.

$$f_x = \frac{d_x}{\sqrt{d_x^2 + d_z^2}} \bullet F$$

$$f_z = \frac{d_z}{\sqrt{d_x^2 + d_z^2}} \bullet F$$

F is the combined speed of vector of X/Y-axis instantaneous speed;  
 $d_x$  is the X-axis instantaneous( $d_i$ ) increment,  
 $f_x$  is the X-axis instantaneous speed in X direction;  
 $d_z$  is the Z-axis instantaneous( $d_i$ ) increment ,  
 $f_z$  is the Z-axis instantaneous speed.

**Example:** In Fig. 2-101, the data in the brackets are the coordinates for each point (it is the diameter in X axis), the system parameter No.022 is 3800, the system parameter No.023 is 7600, the rapid override and feedrate override are 100%.

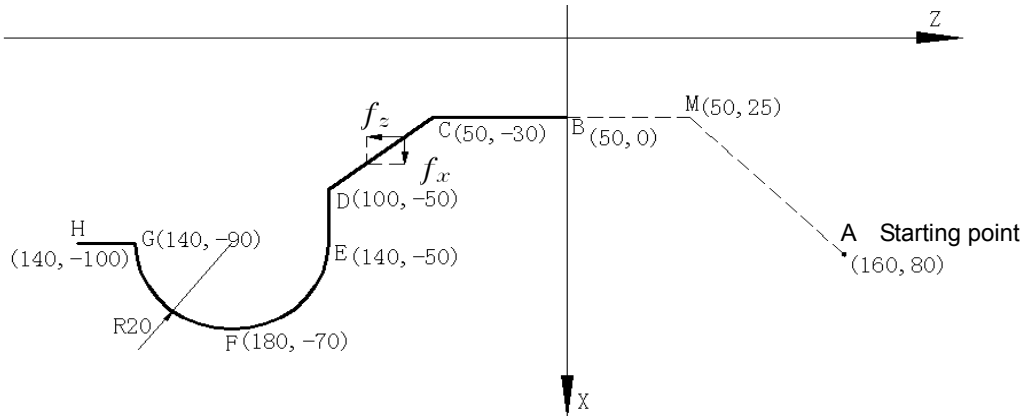

Fig. 3-50

Program as follows:

```
G50 X160 Z80; (Create a workpiece coordinate system)
G0 G98 X50 Z0; (Rapid traverse from A to B through M point. A→M: X-axis rapid traverse
speed 7600mm/min, Z-axis 7600mm/min in Z direction, M→B: X-axis
rapid traverse
speed 0mm/min, Z-axis 7600mm/min in Z direction)
G1 W-30 F100; (B→C, X-axis rapid traverse speed 0mm/min, Z-axis 100mm/min)
X100 W-20; (C→D, X-axis rapid traverse speed 156mm/min, Z-axis 62mm/min)
X140; (D→E, X-axis rapid traverse speed 200mm/min, Z-axis 0mm/min)
G3 W-100 R20; (EFG circular interpolation, E point: X axis instantaneous speed 200mm/min,
Z axis 0mm/min
F point: X-axis instantaneous speed 0mm/min,
Z axis 100mm/min)
W-10; (G→H, X axis rapid traverse speed 0 mm/min, Z axis 100mm/min)
M30;
```

The system supplies 16 steps for spindle override (0%~150%, increment of 10%). PLC ladder defines tune ways of spindle override and whether the actual feedrate override steps is reserved or not after the system is switched off, which is referred by user manual from machine manufacturer when using the system. Refer to the following functions of GSK980TDC standard PLC ladder.

The cutting feedrate can be tuned real time by the feedrate override key on the operator panel or the external override switch, and the actual cutting feedrate is tuned at 16 steps in 0~150% (increment of 10%) but it is invalid for thread cutting to tune the feedrate override. Refer to **II OPERATION** about cutting feedrate override.

**Related parameters:**

- System parameter No.027: the upper limit value of cutting feedrate(they are the same in X, Z direction, diameter/min in X direction);
- System parameter No.029: exponential function for time constant of acceleration/deceleration when cutting feed and manual feed;
- System parameter No.030: initial (ultimate) speed of acceleration/deceleration in exponential function when cutting feed and manual feed.



## 3.24. Additional Axis Function

### 3.24.1 Additional axis start

Additional axis: Y, 4<sup>th</sup>, 5<sup>th</sup>. They can be set to the linear axis or rotary axis. Whether the selected additional axis is valid is determined by the state bit parameter 187, 189, 191, and the axis name is changed by data parameter 224, 225, 226; taking example of Y is as follows:

### 3.24.2 Motion of additional axis

- A. rapidly traverse: G00 Y(V)\_\_\_
- B. feed motion: (G98/G99) G01 Y(V)\_\_\_ F\_\_\_
- C. tapping: G33 Y(V)\_\_\_ F(I)\_\_\_
- D. machine zero return: G28 Y(V)\_\_\_
- E. machine 2<sup>nd</sup>, 3<sup>rd</sup>, 4<sup>th</sup> reference point return: G30 P2(3,4) Y(V)\_\_\_
- F. G50 setting a coordinate system: G50 Y(V)\_\_\_
- G. Manual/Step/MPG feed, program zero return, manual machine zero return.

**Note 1:** Axis name is Y, absolute coordinate programming axis is Y, relative coordinate programming axis is V. Axis name is C, absolute coordinate axis name is C, relative coordinate axis name is H. When axis name is A or B, the relative coordinate programming axis name and absolute coordinate programming axis name are the same.

**Note 2:** The additional axis Y does not execute X/Z interpolation motion;

**Note 3:** Y(V) in G00, G28, X(U), Z(W) are in the same block, and each rapidly traverses with their separately specified speed;

**Note 4:** Y(V) in G50, X(U), Z(W) are in the same block;

**Note 5:** Y(V) in G01, X(U), Z(W) are not in the same block, otherwise, the system alarms;

**Note 6:** Use the modal F of X/Z when G01 traverse speed of Y is not specified; the time constant is set by №29.

### 3.24.3 Additional axis coordinates display



## 3.25 Macro Commands

GSK980TDc provides the macro command which is similar to the high language, and can realize the variable assignment, and subtract operation, logic decision and conditional jump by user macro command, contributed to compiling part program for special workpiece, reduce the fussy counting and simplify the user program.

### 3.25.1 MACRO variables

- **Presentation of macro variables**

Present with “#” + macro variables number.;

Format: # i(i=100,102,103,.....) ;

Example: #105, #109, #125.

- **Variable Type**

The variable is divided into four types according to the variable number:

Number NO.	Variable type	Function
#0	Null variable	The variable is null and is not valued.
#1~#33	Local variable	The local variable is used to store data in the macro program, such as result. When the system is turned off, the local variable is initialized to be null. When the macro program is called, the argument values to the local.
#100~#199 #500~#999	Share variable	The share variable has the same meaning in the different macro program. When the system is turned off, the variable #100~#199 is initialized to be null, #500~#999 is saved and is not lost.
#1000~	System variable	System variable

- **Macro variables reference**

1. Macro variables can replace command values

Format: < Address > +“# i” or < Address > +“-# l”. It shows the system takes variable value or negative value of variable value as address value.

Example: F#103...when #103=15, its function is the same that of F15;

Z-#110...when #110=250, its function is the same that of Z-250;

2. Macro variables can replace macro variables values.

Format: “#”+“9”+macro variables number

Example: if #100 = 205, #105 = 500,

The command function of X#9100 is the same as X500;

The command function of X-#9100 is the same as X-500

**Note 1:** The address O, G and N cannot refer macro variables. For example, O#100, G#101, N#120 are illegal;

**Note 2:** If macro variables values exceed the maximum rang of command values, they cannot be used. For example: #130 = 120, M#130 exceeds the maximum command value.

- **Null variable**

When the variable value is not defined, it is null, the variable #0 is always null and only is read instead of writing.

- a. Reference

When an undefined variable (null variable) is referred, the address is ignored.

#1=<null>	#1=0
G00 X100 Z#1 is equal to G00 X100	G00 X100 Z#1 is equal to G00 X100 Z0

b. Operation

Except for using <null variable > to value, the <null variable> used to operation in other conditions is the same as that of “0”.

#1=<null>	#1=0
#2=#1 ↓(execution result) #2=<null>	#2=#1 ↓(execution result) #2=0
#2=#1 * 5 ↓(execution result) #2=0	#2=#1 * 5 ↓(execution result) #2=0
#2=#1+#1 ↓(execution result) #2=0	#2=#1+#1 ↓(execution result) #2=0

c. Condition expression

<null>s in EQ(=) & NE(≠) are different to “0”.

#1=<null>	#1=0
#1 EQ #0 ↓ Valid	#1 EQ #0 ↓ Invalid
#1 NE #0 ↓ Invalid	#1 NE #0 ↓ Invalid
#1 GE #0 ↓ Valid	#1 GE #0 ↓ Invalid
#1 GT #0 ↓ Invalid	#1 GT #0 ↓ Invalid

- Variable display

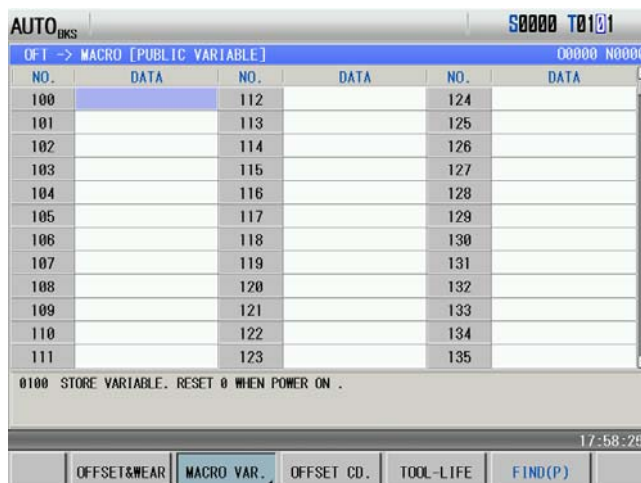

- (1) In macro window, the variable being displayed to the null means it is null, i.e. it is not defined. The variable being displayed to "\*\*\*\*\*" means it exceeds the displayable range.
- (2) The share variable (#100~#199, #500~#999) values are displayed in the macro variable window, and is also displayed the window, the data is input directly to value the share variable.
- (3) The local variable (#1~#33) and the system variable values are not displayed. Some local variable or system variable value is displayed by assigned with the share variable.

● System variable

(1) Interface signal: CNC only executes G and F signals. Whether there are I/O to correspond to it is defined by PLC.

Variable No.	Function
#1000~#1015	Correspond G54.0~G54.7, G55.0~G55.7 signal states
#1032	Correspond G54, G55 signal states
#1100~#1115	Correspond F54.0~G54.7, F55.0~F55.7 signal states
#1132	Correspond F54, F55 signal states
#1133	Correspond F56, F57, F58, F59 signal states

(2) Tool compensation system variable:

Compensation No.	X compensation value		Z compensation value		Tool tip radius compensation value		Imagery tool tip position T	Y compensation value	
	Wear	Geometric shape	Wear	Geometric shape	Wear	Geometric shape		Wear	Geometric shape
1	#2001	#2701	#2101	#2801	#2201	#2901	#2301	#2401	#2451
...	...	...	...	...	...	...	...	...	...
32	#2032	#2732	#2132	#2832	#2232	#2932	#2332	#2432	#2482

(3) Machined workpiece number:

Variable No.	Function
#3901	Machined workpiece number(completion)

(4) System modal information variable

Variable No.	Function
#4001	G00, G01, G02, G03, G05, G32, G33, G34, G80, G84, G88, G90, G92, G94, G124(G06.2), G126(G06.3), G132(G32.1), G144(G07.2), G146(G07.3)
#4002	G96, G97
#4005	G98, G99
#4006	G20, G21
#4007	G40, G41, G42
#4012	G66, G67
#4013	G54, G55, G56, G57, G58, G59
#4016	G17, G18, G19
#4109	F command

#4113	M command
#4114	Serial No.
#4115	Program No.
#4119	S command
#4120	T command

(5) system variable of coordinate position information:

Variable No.	Position signal	Coordinate system	Tool compensation value	Read in running
#5001~#5005	End point of block	Workpiece coordinate system	Not including	Possible
#5021~#5025	Current position	Machine coordinate system	Including	impossible
#5041~#5045	Current position	Workpiece coordinate system		

**Note:** The position listed in the above table separately corresponds orderly to X, Y, Z, 4<sup>th</sup>, 5<sup>th</sup> axis. For example: #5001 meanings to be X position information, #5002 meanings to be Y position information, #5003 meanings to be Z position information and #5004 meanings to 4<sup>th</sup> position information and #5005 meanings to 5<sup>th</sup> position information.

(6) Compensation values of workpiece coordinate systems

Variable No.	Function
#5201~#5205	External workpiece zero offset value of 1 <sup>st</sup> ~5 <sup>th</sup> axis
#5221~#5225	G54 workpiece zero offset value of 1 <sup>st</sup> ~5 <sup>th</sup> axis
#5241~#5245	G55 workpiece zero offset value of 1 <sup>st</sup> ~5 <sup>th</sup> axis
#5261~#5265	G56 workpiece zero offset value of 1 <sup>st</sup> ~5 <sup>th</sup> axis
#5281~#5285	G57 workpiece zero offset value of 1 <sup>st</sup> ~5 <sup>th</sup> axis
#5301~#5305	G58 workpiece zero offset value of 1 <sup>st</sup> ~5 <sup>th</sup> axis
#5321~#5325	G59 workpiece zero offset value of 1 <sup>st</sup> ~5 <sup>th</sup> axis

**Note:** Message described in the above table separately corresponds to X, Y, Z, the 4<sup>th</sup>, 5<sup>th</sup> axis. For example, #5201 means the offset message of X axis, #5202 means the one of Y axis, #5203 means the one of Z axis, #5204 means the one of the 4th axis, #5205 means the one of the 5th axis.

(7) Application:

<p>O0100; (#100 is the machined workpiece number, its initial value=0)          G00 X100 Z100;          T0101;          IF[#100&lt;100]GOTO10; (has continuously machined 100? )          G65 P9580 U-0.01 W-0.01; (call the macro program compensation tool wear)          N10 G00 X50 Z50;          .....;          .....;          .....;          Machine program;          .....;          T0202;          IF[#100&lt;100]GOTO20; (has continuously machined 100? )          G65 P9580 U-0.01 W-0.01; (call the macro program compensation tool wear)          N20 .....;          .....;          .....;          #100=#100+1; (machined workpiece number +1)          IF[#100==101]THEN #100=0;          M30;</p>	<p>O9580;          G65 H23 P#101 Q#4120 R100; (obtain the tool offset No.)          #102=2000+#101; (X wear macro variable)          #103=2100+#101; (Z wear macro variable)          #9102=#9102+#21; (modify X wear)          #9103=#9103+#23; (modify Z wear)          T#4120; (call a new tool offset value)          M99;</p>
--	--

### 3.25.2 Operation and jump command G65

**Command format:**

G65 H $\underline{m}$  P# $\underline{i}$  Q# $\underline{j}$  R# $\underline{k}$ ;

m: operation or jump command, range 01~99.

# i: macro variables name for storing values.

# j: macro variables name 1 for operation, can be constant.

# k: macro variables name 2 for operation, can be constant.

**Command significance:** # i = #j O # k



Example: P#100 Q#101 R#102.....#100 = #101 O #102;

P#100 Q#101 R15....#100 = #101 O 15;

P#100 Q-100 R#102.....#100 = -100 O #102;

**Note:** Macro variable name has no “#” when it is presented directly with constant.

**Macro command list**

Command format	Functions	Definitions
G65 H01 P# $\underline{i}$ Q# $\underline{j}$	Assignment	# i = # j assign value of j to i
G65 H02 P# $\underline{i}$ Q# $\underline{j}$ R# $\underline{k}$ ;	Decimal add operation	# i = # j + # k
G65 H03 P# $\underline{i}$ Q# $\underline{j}$ R# $\underline{k}$ ;	Decimal subtract operation	# i = # j - # k

Command format	Functions	Definitions
G65 H04 P#i Q#j R#k;	Decimal multiplication operation	# i = # j × # k
G65 H05 P#i Q#j R#k;	Decimal division operation	# i = # j ÷ # k
G65 H11 P#i Q#j R#k;	Binary addition	# i = # j OR # k
G65 H12 P#i Q#j R#k;	Binary multiplication(operation)	# i = # j AND # k
G65 H13 P#i Q#j R#k;	Binary exclusive or	# i = # j XOR # k
G65 H21 P#i Q#j;	Decimal square root	# i = $\sqrt{\# j}$
G65 H22 P#i Q#j;	Decimal absolute value	# i =  # j
G65 H23 P#i Q#j R#k;	Decimal remainder	Remainder of # i = (#j ÷ # k)
G65 H24 P#i Q#j;	Decimal into binary	# i = BIN(# j)
G65 H25 P#i Q#j;	Binary into decimal	# i = DEC(# j)
G65 H26 P#i Q#j R#k;	Decimal multiplication/division operation	# i = # i × # j ÷ # k
G65 H27 P#i Q#j R#k;	Compound square root	# i = $\sqrt{\# j^2 + \# k^2}$
G65 H31 P#i Q#j R#k;	Sine	# i = # j × sin(# k)
G65 H32 P#i Q#j R#k;	Cosine	# i = # j × cos(# k)
G65 H33 P#i Q#j R#k;	Tangent	# i = # j × tan(# k)
G65 H34 P#i Q#j R#k;	Arc tangent	# i = ATAN(# j / # k)
G65 H80 Pn;	Unconditional jump	Jump to block n
G65 H81 Pn Q#i R#k;	Conditional jump 1	Jump to block n if # j = # k, otherwise the system executes in order
G65 H82 Pn Q#i R#k;	Conditional jump 2	Jump to block n if # j ≠ # k, otherwise the system executes in order
G65 H83 Pn Q#i R#k;	Conditional jump 3	Jump to block n if # j > # k, otherwise the system executes in order
G65 H84 Pn Q#i R#k;	Conditional jump 4	Jump to block n if # j < # k, otherwise the system executes in order
G65 H85 Pn Q#i R#k;	Conditional jump 5	Jump to block n if # j ≥ # k, otherwise the system executes in order
G65 H86 Pn Q#i R#k;	Conditional jump 6	Jump to block n if # j ≤ # k, otherwise the system executes in order
G65 H99 Pn;	P/S alarm	(500+n) alarms

### 1 Operation commands

1) Assignment of macro variables: # I = # J

#### **G65 H01 P#I Q#J**

(Example) G65 H01 P# 101 Q1005; (#101 = 1005)

G65 H01 P#101 Q#110; (#101 = #110)

G65 H01 P#101 Q-#102; (#101 = -#102)

2) Decimal add operation: # I = # J + # K

#### **G65 H02 P#I Q#J R#K**

(Example) G65 H02 P#101 Q#102 R15; (#101 = #102+15)

- 3) Decimal subtract operation: # I = # J - # K  
**G65 H03 P#I Q#J R# K**  
 (Example) G65 H03 P#101 Q#102 R#103; (#101 = #102 - #103)
- 4) Decimal multiplication operation: # I = # J \* # K  
**G65 H04 P#I Q#J R#K**  
 (Example) G65 H04 P#101 Q#102 R#103; (#101 = #102 \* #103)
- 5) Decimal division operation: # I = # J ÷ # K  
**G65 H05 P#I Q#J R#K**  
 (Example) G65 H05 P#101 Q#102 R#103; (#101 = #102 ÷ #103)
- 6) Binary logic add(or) : # I = # J.OR. # K  
**G65 H11 P#I Q#J R#K**  
 (Example) G65 H11 P#101 Q#102 R#103; (#101 = #102.OR. #103)
- 7) Binary logic multiply(and) : # I = # J.AND. # K  
**G65 H12 P#I Q#J R#K**  
 (Example ) G65 H12 P# 201 Q#102 R#103; (#101 = #102.AND.#103)
- 8) Binary executive or: # I = # J.XOR. # K  
**G65 H13 P#I Q#J R#K**  
 (Example) G65 H13 P#101 Q#102 R#103; (#101 = #102.XOR. #103)
- 9) Decimal square root: # I =  $\sqrt{\#J}$   
**G65 H21 P#I Q#J**  
 (Example) G65 H21 P#101 Q#102 ; (#101 =  $\sqrt{\#102}$ )
- 10) Decimal absolute value: # I = | # J |  
**G65 H22 P#I Q#J**  
 (Example) G65 H22 P#101 Q#102 ; (#101 = | #102 |)
- 11) Decimal remainder: # I = # J - TRUNC(#J/#K) \* # K, TRUNC: omit decimal fraction  
**G65 H23 P#I Q#J R#K**  
 (Example) G65 H23 P#101 Q#102 R#103; (#101 = #102 - TRUNC (#102/#103) \* #103)
- 12) Decimal converting into binary: # I = BIN (# J)  
**G65 H24 P#I Q#J**  
 (Example) G65 H24 P#101 Q#102 ; (#101 = BIN(#102) )
- 13) Binary converting into decimal: # I = BCD (# J)  
**G65 H25 P#I Q#J**  
 (Example) G65 H25 P#101 Q#102 ; (#101 = BCD(#102) )
- 14) Decimal multiplication/division operation: # I = (# I \* # J) ÷ # K  
**G65 H26 P#I Q#J R# k**  
 (Example) G65 H26 P#101 Q#102 R#103; (#101 = (# 101 \* # 102) ÷ #103)
- 15) Compound square root: # I =  $\sqrt{\#J^2 + \#K^2}$   
**G65 H27 P#I Q#J R#K**  
 (Example) G65 H27 P#101 Q#102 R#103; (#101 =  $\sqrt{\#102^2 + \#103^2}$  )
- 16) Sine: # I = # J \* SIN(# K) (Unit: ‰)  
**G65 H31 P#I Q#J R#K**  
 (Example) G65 H31 P#101 Q#102 R#103; (#101 = #102 \* SIN(#103) )
- 17) Cosine: # I = # J \* COS(# K) (Unit: ‰)  
**G65 H32 P#I Q#J R# k**  
 (Example) G65 H32 P#1Q#102 R#103; (#101 = #102 \* COS(#103) )



18) Tangent: # I = # J•TAM(# K) (Unit: ‰)

**G65 H33 P#I Q#J R# K**

(Example) G65 H33 P#101 Q#102 R#103; (#101 = #102•TAM(#103) )

19) Cosine: # I = ATAN(# J /# K) (Unit: ‰)

**G65 H34 P#I Q#J R# k**

(Example) G65 H34 P#101 Q#102 R#103; (#101 =ATAN(#102/#103) )

## 2 Jump commands

1) Unconditional jump

**G65 H80 Pn; n: Block number**

(Example) G65 H80 P120; (jump to N120)

2) Conditional jump 1 #J.EQ.# K ( = )

**G65 H81 Pn Q#J R# K; n: Block number**

(Example) G65 H81 P1000 Q#101 R#102;

The program jumps N1000 when # 101= #102 and executes in order when #101 ≠#102.

3) Conditional jump 2 #J.NE.# K ( ≠ )

**G65 H82 Pn Q#J R# K; n: Block number**

(Example) G65 H82 P1000 Q#101 R#102;

The program jumps N1000 when # 101 ≠ #102 and executes in order when #101 = #102.

4) Conditional jump 3 #J.GT.# K ( > )

**G65 H83 Pn Q#J R# K; n: Block number**

(Example) G65 H83 P1000 Q#101 R#102;

The program jumps N1000 when # 101 > #202 and executes in order when #101 ≤ #102.

5) Conditional jump 4 #J.LT.# K ( < = )

**G65 H84 Pn Q#J R# K; n: Block number**

(Example) G65 H84 P1000 Q#101 R#102;

The program jumps N1000 when # 101<#102 and executes in order when #101≥#102.

6) Conditional jump 5 #J.GE.# K ( ≥ )

**G65 H85 Pn Q#J R# K; n: Block number**

(Example) G65 H85 P1000 Q#101 R#102;

The program jumps N1000 when # 101 ≤ #1 and executes in order when #101 < #102.

7) Conditional jump 6 #J.LE.# K ( ≤ )

**G65 H86 Pn Q#J R# K; n: Block number**

(Example) G65 H86 P1000 Q#101 R#102;

8) P/S alarm

**G65 H99 Pi; i: alarm number +500**

(Example) G65 H99 P15;

P/S alarm 515.

**Note:** Block number can be specified by variables. Such as: G65 H81 P#100 Q#101 R#102;  
The program jumps to block that its block number is specified by #100.

### 3.25.3 Program example with macro command

Differences between user macro program call (G65, G66) and subprogram call (M98) are as follows:

1. G65, G66 can specify the argument data and send them to macro program and M98 has no such function.

2. G65, G66 can change the level of local variable and M98 has no such function.
3. G65, G66 only follows N and only P or H follows them.

3.25.3.1 Non-modal call G65

**Command format:** G65 P\_ L\_ <argument>;

Macro program specified by P is called, the argument (data) is send to the user macro program body.

**Command explanation:**

P —— called macro program number

L —— called times (it is 1 when it is omitted, it can be the repetitive times from 1 to 9999)

<argument> \_\_ data sent to macro program is valued with the corresponding local variable.

Nest call: G65 call has four-level nest.

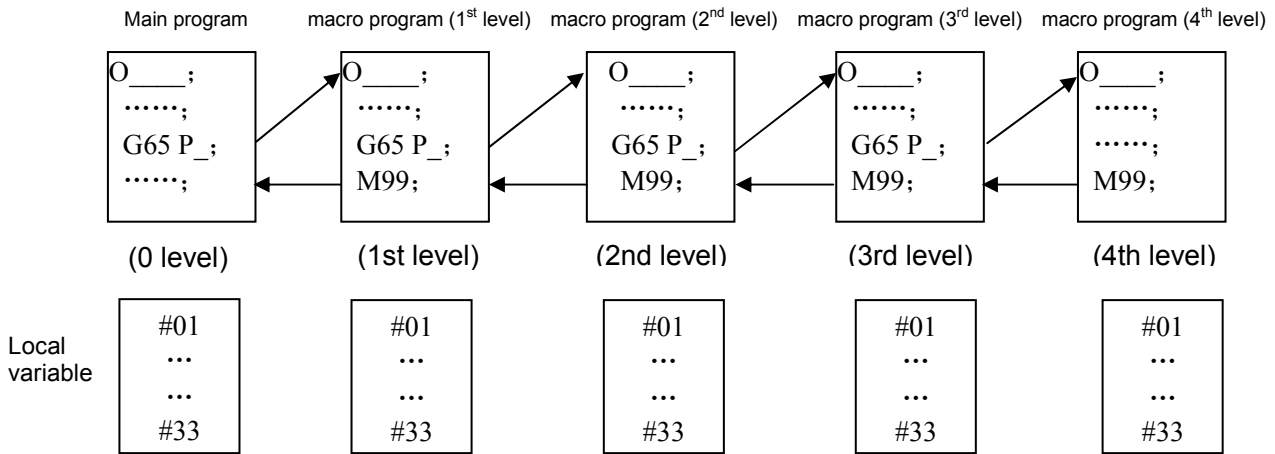

**Specifying argument:** the argument can be specified by two forms.

Method 1: use the letter besides G, L, O, N, P, and each is only specified one time, and the last which is specified many times is valid.

Argument address and corresponding variable No. table in method 1

Address	Variable No.	Address	Variable No.	Address	Variable No.
A	#1	I	#4	T	#20
B	#2	J	#5	U	#21
C	#3	K	#6	V	#22
D	#7	M	#13	W	#23
E	#8	Q	#17	X	#24
F	#9	R	#18	Y	#25
H	#11	S	#19	Z	#26

**Note:** The addresses which are not needed to specify can be omitted, the corresponding local variable of the omitted address is valued by <null>.

Method II: use A, B, C and li, Ji, Ki (l is 1~10), the used letter and executed times(l, J, K) automatically decides the corresponding variable number of argument. The argument in the method specifies A, B, C one time for each and I, J, K up to 10 times ( 10 times replacing the more).

**Argument address and corresponding variable No. table in method II**

Address	Variable No.	Address	Variable No.	Address	Variable No.
A	#1	K <sub>3</sub>	#12	J <sub>7</sub>	#23
B	#2	I <sub>4</sub>	#13	K <sub>7</sub>	#24
C	#3	J <sub>4</sub>	#14	I <sub>8</sub>	#25
I <sub>1</sub>	#4	K <sub>4</sub>	#15	J <sub>8</sub>	#26
J <sub>1</sub>	#5	I <sub>5</sub>	#16	K <sub>8</sub>	#27
K <sub>1</sub>	#6	J <sub>5</sub>	#17	I <sub>9</sub>	#28
I <sub>2</sub>	#7	K <sub>5</sub>	#18	J <sub>9</sub>	#29
J <sub>2</sub>	#8	I <sub>6</sub>	#19	K <sub>9</sub>	#30
K <sub>2</sub>	#9	J <sub>6</sub>	#20	I <sub>10</sub>	#31
I <sub>3</sub>	#10	K <sub>6</sub>	#21	J <sub>10</sub>	#32
J <sub>3</sub>	#11	I <sub>7</sub>	#22	K <sub>10</sub>	#33

**Note 1:** The subscripts of I, J, K are used to confirming the specified sequence of argument, and are not written in the actual programming.

**Note 2:** The system can identify the variable number according to the present sequence and times of I, J, K in the method.

**If the block has:** G65 P9010 A1 B2 C3 I14 J15 I6 J7 K9 K11 K12 J30;

Call program O9010, transfer the argument A1 to the local variable, and their corresponding relationship as follows:

#1=1, #2=2, #3=3, #4=14, #5=15, #7=6, #8=7, #6=9, #9=11, #12=12, #11=30;

The specified method I, II compound of argument: CNC can automatically identifies the specified method I and II of the argument. When the two methods are specified together, the later specifies is valid.

#### **Argument specifying mode I, II compound:**

CNC internal can automatically identify the argument specifying mode I and II. When the two modes are specified, the later specified is valid.

#### 3.25.3.2 Modal call G66

**Command format:** G66 P\_ L\_ <argument>\_;

**Command explanation:** P \_\_\_ called macro program number

L \_\_\_ called times (it is 1 when it is omitted, it can be the repetitive times from 1 to 9999)

<argument> \_\_\_ data sent to macro program is valued with the corresponding local variable.

**Nest call:** G65 call has four-level nest.

#### **Modal call explanation:**

1. Macro program is called firstly after G66 block is executed.
2. The macro program is called again after G00, G01, G02, G03, G05 are executed (after G66 is executed and before the modal call is cancelled).
3. Call the value which is updated from the argument to the local variable.
4. G65 call will automatically cancel G66 modal call.

#### 3.25.3.3 Modal call cancel G67

- **Modal call cancel (G67)**

**Command format:** G67;

**Command explanation:** cancel G66 modal macro program call

Application:

O2005(O2005) ;

G00 X100 Z50;

G66 P0100 L2 A2 B20 C20 I30 J20 K20; call P0100 two times when the system executes the block  
G01 X80 Z50; call P0100 two times (update the local variable according to the argument) after the  
system has executed the block

G67; cancel G66 modal call

G01 X20 Z50; the system does not call P0100 after it executes the block

M30;

### 3.26 Statement Macro Command

#### 3.26.1 Arithmetic and logic operation

Table 3-20 Arithmetic and logic operation

Function	Expression format	Remark
Definition or assignment	#i = #j	
addition	#i = #j + #k	
subtraction	#i = #j - #k	
multiplication	#i = #j * #k	
division	#i = #j / #k	
Or	#i = #j OR #k	Logic operation is executed by the binary system
And	#i = #j AND #K	
Exclusive Or	#i = #j XOR #K	
Square root	#i = SQRT[#j]	
Absolute value	#i = ABS[#j]	
Rounding-off	#i = ROUND[#j]	
FUP	#i = FUP [#j]	
FIX	#i = FIX [#j]	
Natural logarithm	#i = LN[#j]	
Exponential function	#i = EXP[#j]	
Sine	#i = SIN[#j]	Angle unit is specified by degree. For example: 90°30' is expressed by 90.5°
Arc sine	#i = ASIN[#j]	
Cosine	#i = COS[#j]	
Arc cosine	#i = ACOS[#j]	
Tangent	#i = TAN[#j]	
Arc tangent	#i = ATAN[#i]/ [#j]	
BCD to BIN	#i = BIN[#j]	Used for switching with PMC
BIN to BCD	#i = BCD[#j]	

**Relative explanation:**

##### 1. Angle unit

Angle units of SIN, COS, ASIN, ACOS, TAN and ATAN are degree (°). For example: 90°30' means to be 90.5° (degree).

2. Arc sine #i=ASIN[#j]
  - i. result output range:
    - No.180#7 NAT is set to 1: 90°~ 270°;
    - No.180#7 NAT is set to 0: -90°~ 90°;
  - ii. when #j exceeds the range from -1 to 1, the system alarms P/S.
  - iii. the constant replaces the variables #j.
3. Arccosine #i=ACOS[#j]
  - i. Result output range 180°~ 0°.
  - ii. When #j exceeds the range from -1 to 1, the system alarms P/S.
  - iii. The constant replaces the variables #j.
4. Arc tangent #i=ATAN[#j]/[#k]
 

Specify the lengths of two sides and separate them with a slash “/”.

  - i. Result output range:
    - When No.180#7 NAT is set to 1: 90°~ 270°;
    - [For example] #1=ATAN[-1]/[-1]: #1=225°;
    - When No.180#7 NAT is set to 0 -90°~ 90°;
    - [For example]#1=ATAN[-1]/[-1]: #1=45.0°;
  - ii. The constant replaces the variables #j.
5. Natural logarithm #i=LN[#j]
  - i. The constant replaces the variables #j
6. Exponential function #i=EXP[#j]
  - i. The constant replaces the variables #j
7. ROUND function
 

When arithmetical operation or logic operation IF or WHILE includes ROUND, ROUND rounds in the first decimal place.

For example:

#1=ROUND[#2]: #2=1.2345, the variables 1 is 1.0.

#### 8. FUP FIX

After CNC executes the operation, the result integer absolute value is bigger the previous absolute value, which is called FUP; the result integer absolute value is less than the one, which is call FIX. Pay more attention to the negative execution.

Example:

Hypothetically, #1=1.2, #2= -1.2

When #3=FUP[#1] is executed, 2.0 is assigned to #3.

When #3=FIX[#1] is executed, 1.0 is assigned to #3.

When #3=FUP[#2] is executed, -2.0 is assigned to #3.

When #3=FIX[#2] is executed, -1.0 is assigned to #3.

### 3.26.2 Transfer and cycle

In the program, the system uses GOTO and IF statement to change the control flow. There are three types of transfer and cycle operation.

1. GOTO statement (unconditional transfer).
2. Condition control IF statement.
3. WHILE cycle statement.

#### 1) Unconditional transfer (GOTO statement )

Transfer to the block which serial number is n. The system alarms when others exceeds the range from 1 to 99999, and it specifies the serial number with the statement.

**Format:** GOTO n; n: serial number(1~99999)

**Example:** GOTO 1;  
GOTO #101;

**2) Conditional control (IF statement )**

**GOTO format:** IF[ conditional statement]GOTO n;

When the specified conditional statement is valid, the system transfers to the block which serial number is n; When the specified conditional statement is valid, the system executes the next block.

**Example:**

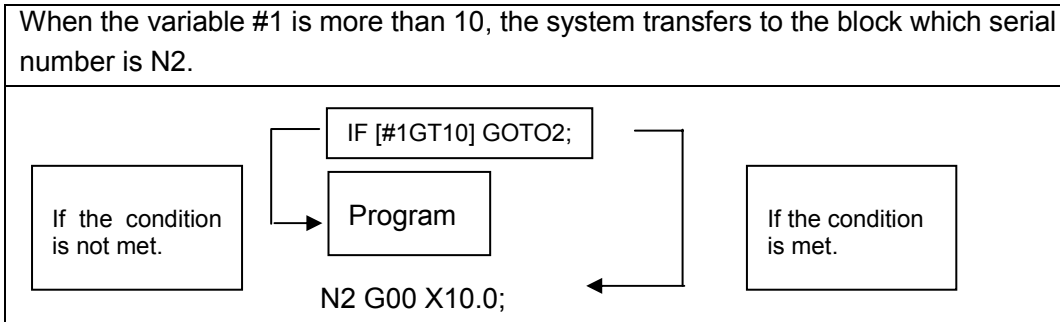

**THEN format:** IF[conditional expression]THEN<macro program statement >;

When the condition expression is valid, the system executes only one statement following THEN.

Example: IF[#1 EQ #2] THEN #3=0;

When #1 value is equal to the #2, 0 is assigned to the variable #3; when they are not equal, the system orderly executes the followings instead of the assignment statement after THEN.

Conditional expression: the conditional expression must include the conditional operator, two sides of conditional operator can be variable, constant or expression, and it must be closed with the brackets '[' ']'.

Conditional operator: the system uses the conditional operators listed in the following table.

Conditional operator	Meaning
EQ or ==	Equal to (=)
NE or <>	Not equal to (≠)
GT or >	More than (>)
GE or >=	More than or equal to (≥)
LT or <	Less than (<)
LE or <=	Less than or equal to (≤)

Example: IF[3<>2]GOTO 2; its meaning: when 3 is not equal 2, the system skips to N2 block;

IF[#101>=7.22]THEN #101=SIN30; its meaning: when #101 is more than or equal to 7.22, the system executes the assignment after THEN. i.e. the sine value of 30 degree is assigned to the variable #101.

Typical program: the following program counts the sum of the integer 1~10.

```
O9500
#1=0; ... ..the sum is initialized to be 0
#2=1; ... ..the summand number is initialized to be 1
N1 IF[#2 GT 10]GOTO 2; ... .. the system skips to N2 when the summand is more than 10
#1= #1+#2; ... ..count the sum of two numbers
#2= #2+1; ... .. the summand adds 1
GOTO 1; ... .. unconditionally skip to the block N1
N2 M30; ... .. end of program
```

**3) Cycle (WHILE statement)**

Specify one conditional expression after WHILE. When the specified conditional is valid, the system executes the blocks between DO and END; otherwise, the system skips to the block after END.

Example:

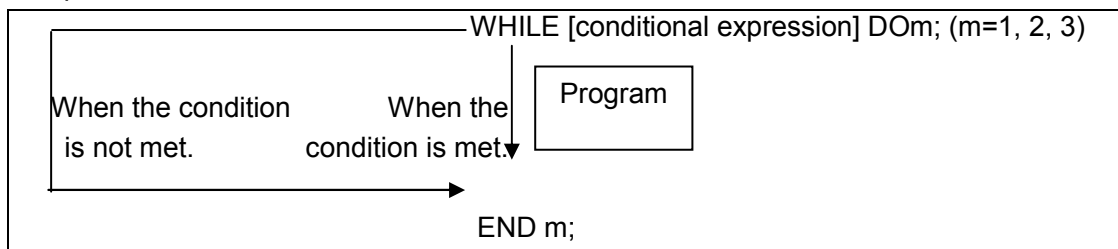

Explanation: when the specified condition is valid, the system executes the block between DO and END; otherwise, executes the block after END. The two tabs after DO and END are consistent, and the tab value can be 1, 2 or 3, otherwise, the system alarms.

Nest: the tab (1~3) in DO, END can be used many times. But the system alarms when there is the intercross repetitive cycle in the program.

<p>1. Tab (1 to 3) can be used many times according to the requirements</p> <pre>WHILE[...]DO1;   Program END 1;   ⋮ WHILE[...]DO1;   Program END 1;</pre> <p>2. DO range does not cross</p> <pre>WHILE[...]DO1;   Program WHILE[...]DO2;   ⋮ END 1;   Program END 2;</pre>	<p>3. DO cycle can nest 3-level</p> <pre>WHILE[...]DO1;   ⋮   WHILE[...]DO2;     WHILE[...]DO3;       Program     END 3;   END 2; END 1;</pre> <p>4. The control can transfer to the outside of the cycle</p> <pre>WHILE[...]DO1;   IF[...]GOTOn; END 1; Nn;</pre> <p>5. The transfer cannot enter the cycle zone</p> <pre>IF[...]GOTOn; WHILE[...]DO1; Nn; END 1;</pre>
---	--

### 3.27 Metric/Inch Switch

Command format: G20; (inch input)

G21; (metric input)

Explanation: input/output unit of CNC system is divided into two, i.e., metric unit: mm and inch unit: inch.

Input unit of modifying the system has also:

Modifying BIT0 (metric/inch): 0: metric input 1: inch input

No. 001# completely corresponds to G20/G21, namely, the parameter also changes when G20/G21 is executed; G20/G21 mode also changes when the parameter is modified, and the alarm prompt occurs after modification. Parameters relevant to metric/inch are referred to Installation & Connection, Section 3.2.17.

#### Notes

##### (1) No.001 # 0(INI) input increment unit change

- ①. After the input increment unit is changed (inch/metric input), the following unit system is changed: (i.e.: mm<>inch; mm/min<>inch/min):
  - F specifies the feedrate (mm/min<>inch/min), thread lead (mm <>inch)
  - position command (mm<>inch)
  - tool compensation value (mm<>inch)
  - MPG graduation unit (mm<>inch)
  - movement distance in incremental feed (mm<>inch)
  - some data parameters, including NO.49~NO.54, NO.56, NO.59, NO.60, NO.114~ NO.116, NO.120~ NO.127, NO.140, No.141, No.154; the unit is 0.001mm(IS-B) in the metric input system, is 0.0001inch(IS-B) in the inch input system. For example, the same parameter NO.49 setting value is 100m, it means to be 0.1mm in the metric input system (G21), and it means 0.01inch in the inch input system (G20).
- ②. The machine coordinates will automatically switch after the input increment unit change is switched:

##### (2) No.004 # 0(SCW) output command unit change

SCW=0: the system minimal command increment uses the metric output (0.001mm)

SCW=1: the system minimal command increment uses the inch output (0.0001inch)

Some data parameter meanings will be changed when the output control bit parameter SCW is changed:

- ①. Speed parameter:
  - Metric machine: mm/min
  - Inch machine: 0.1 inch/min
  - Example: when the speed is set to 3800, the metric machine is 3800 mm/min and the inch machine is 380 inch/min.
  - Speed parameters: No.22, No.23, No.27, No.28~No.31, No.32, No.33, No.41, No.107, No.113;
- ②. Position(length) parameter
  - metric machine: 0.001 mm
  - inch machine: 0.0001 inch
  - When the setting is 100, the metric machine is 0.1mm and the inch machine is 0.01



inch.

Position parameters: No.34, No.35, No.37~No.40, No.45~No.48, No.102~No.104 and all pitch error compensation parameter;

**Note 1: When the minimal input increment unit and the minimal command unit are different, the maximal error is the half of minimal command unit. The error cannot be accumulated.**

**Note 2: The current system increment is IS-B in the above explanation.**

## CHAPTER 4 TOOL NOSE RADIUS COMPENSATION (G41, G42)

### 4.1 Application

#### 4.1.1 Overview

Part program is compiled generally for one point of tool according to a workpiece contour. The point is generally regarded as the tool nose A point in an imaginary state (there is no imaginary tool nose point in fact and the tool nose radius can be omitted when using the imaginary tool nose point to program) or as the center point of tool nose arc ( as Fig. 4-1). Its nose of turning tool is not the imaginary point but one arc owing to the processing and other requirement in the practical machining. There is an error between the actual cutting point and the desired cutting point, which will cause the over- or under-cutting affecting the part precision. So a tool nose radius compensation is needed in machining to improve the part precision.

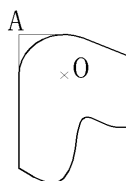

Fig. 4-1 Tool

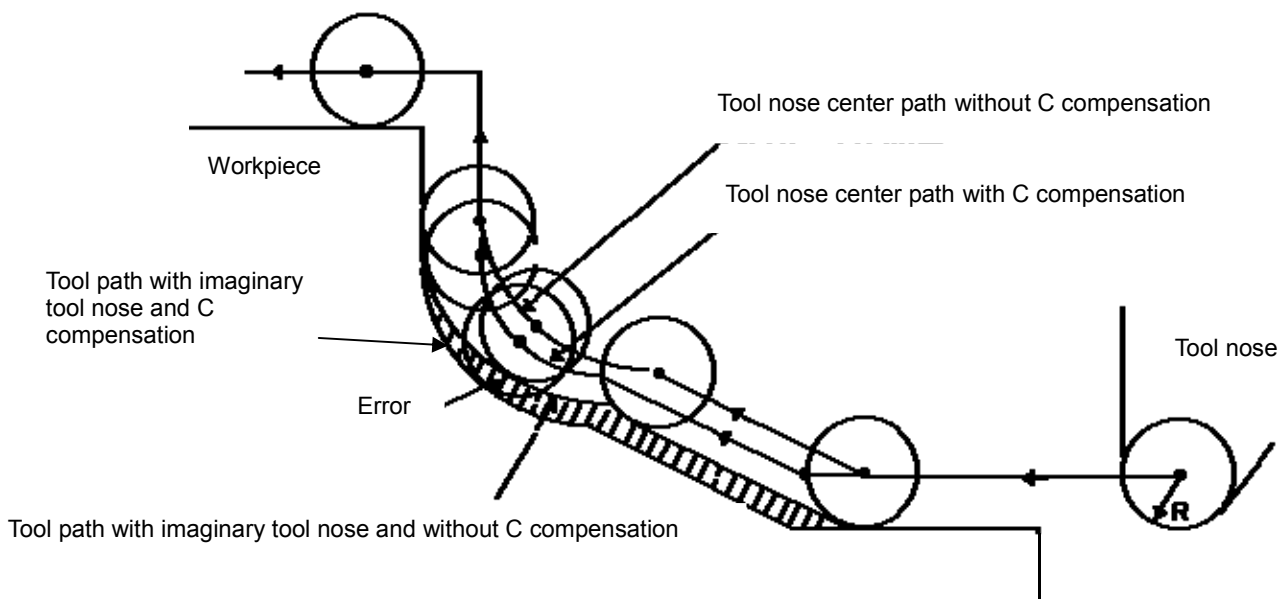

Fig. 4-2 Tool nose center path

#### 4.1.2 Imaginary tool nose direction

Suppose that it is generally difficult to set the tool nose radius center on the initial position as Fig. 4-3; suppose that it is easily set the tool nose on it as Fig. 4-4; The tool nose radius can be omitted in programming. Fig. 4-5 and Fig.4-6 correspond separately to the tool paths of tool nose center programming and imaginary tool nose programming when tool nose radius is executed or not.

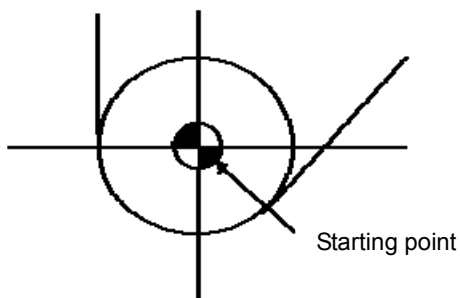

Fig. 4-3 Programming with tool nose

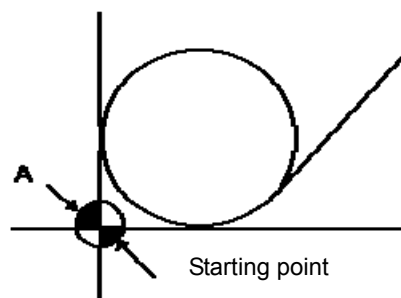

Fig. 4-4 Programming with imaginary tool nose

Tool path is shown in Fig.4-5 when the tool nose center programming is executed.

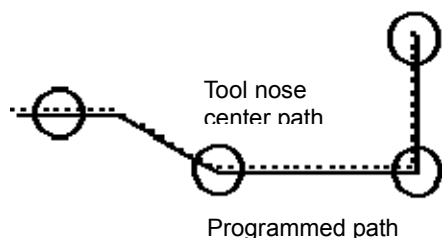

Fig. 4-5-1 the tool nose center path is the same that of programmed path without tool radius compensation

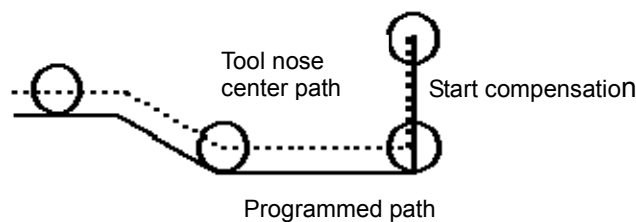

Fig. 4-5-2 precise cutting with tool radius compensation

The tool path is shown in Fig. 4-6 when imaginary tool nose programming is executed

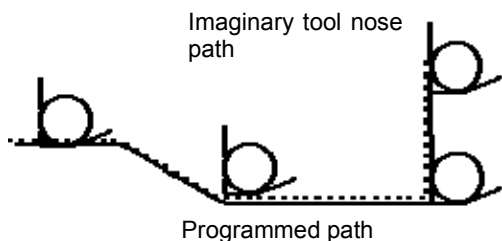

Fig. 4-6-1 the imaginary tool nose path is the same that of programmed path without tool radius compensation

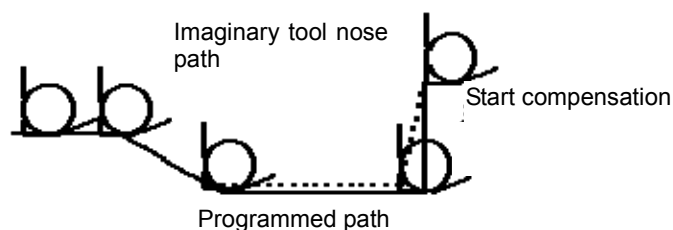

Fig. 4-6-2 precise cutting with tool radius compensation

The tool is supposed to one point in programming but the actual cutting blade is not one ideal point owing to machining technology. Because the cutting blade is not one point but one circular, machining error is caused which can be deleted by tool nose circular radius compensation. In actual machining, suppose that there are different position relationship between tool nose point and tool nose circular center point, and so it must create correct its direction of imaginary tool nose.

From tool nose center to imaginary tool nose, set imaginary tool nose numbers according to tool direction in cutting. Suppose there are 10 kinds of tool nose setting and 9 directions for position relationship. The tool nose directions are different in different coordinate system (rear tool post coordinate system and front tool post coordinate system) even if they are the same tool nose direction numbers as the following figures. In figures, it represents relationships between tool nose and starting point, and end point of arrowhead is the imaginary tool nose; T1~T8 in rear tool post coordinate system is as Fig. 4-7; T1~T8 in front tool post coordinate system is as Fig. 4-8. The tool

nose center and starting point for T0 and T9 are shown in Fig. 4-9.

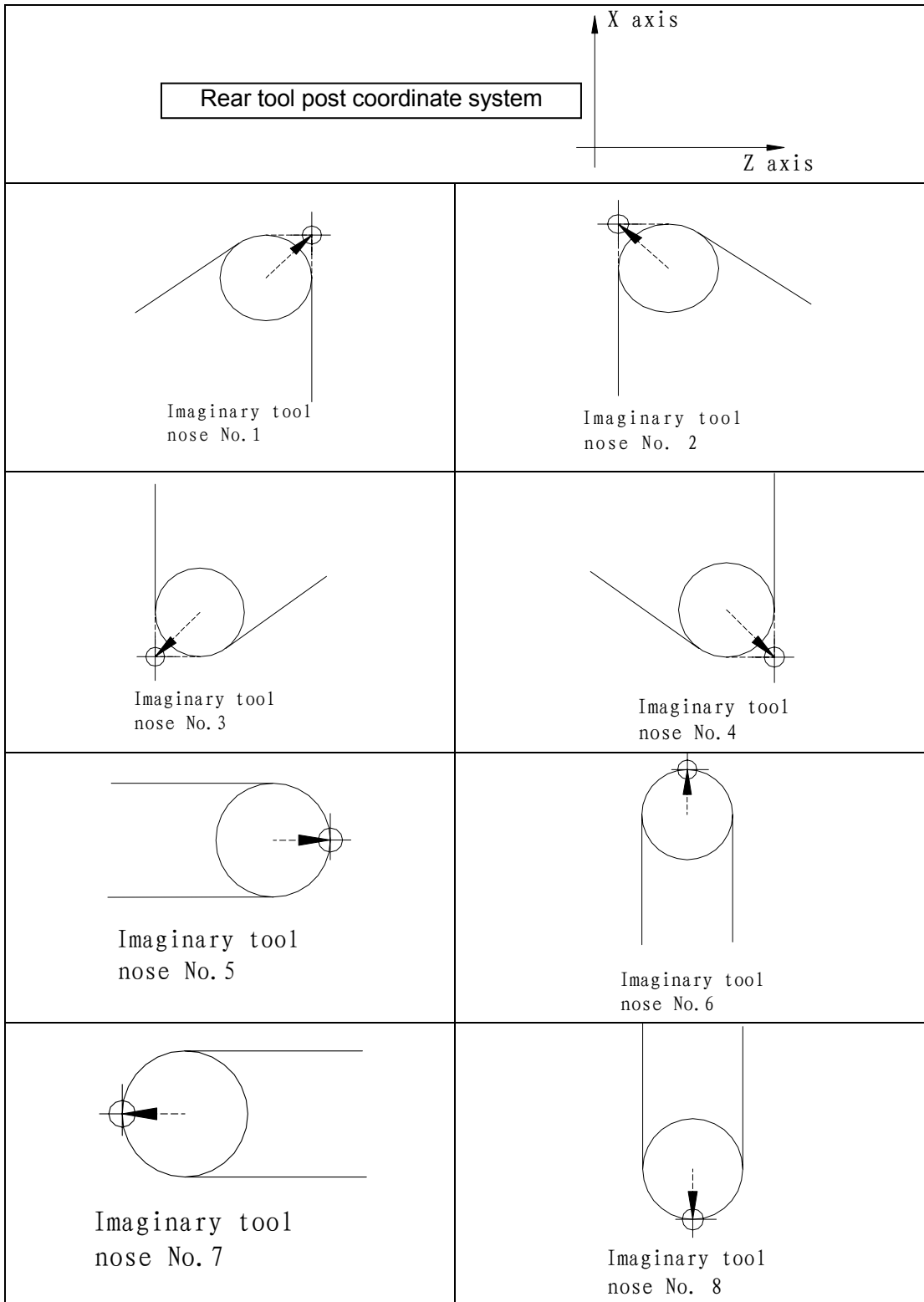

Fig. 4-7 Imaginary tool nose number in rear tool post coordinate system

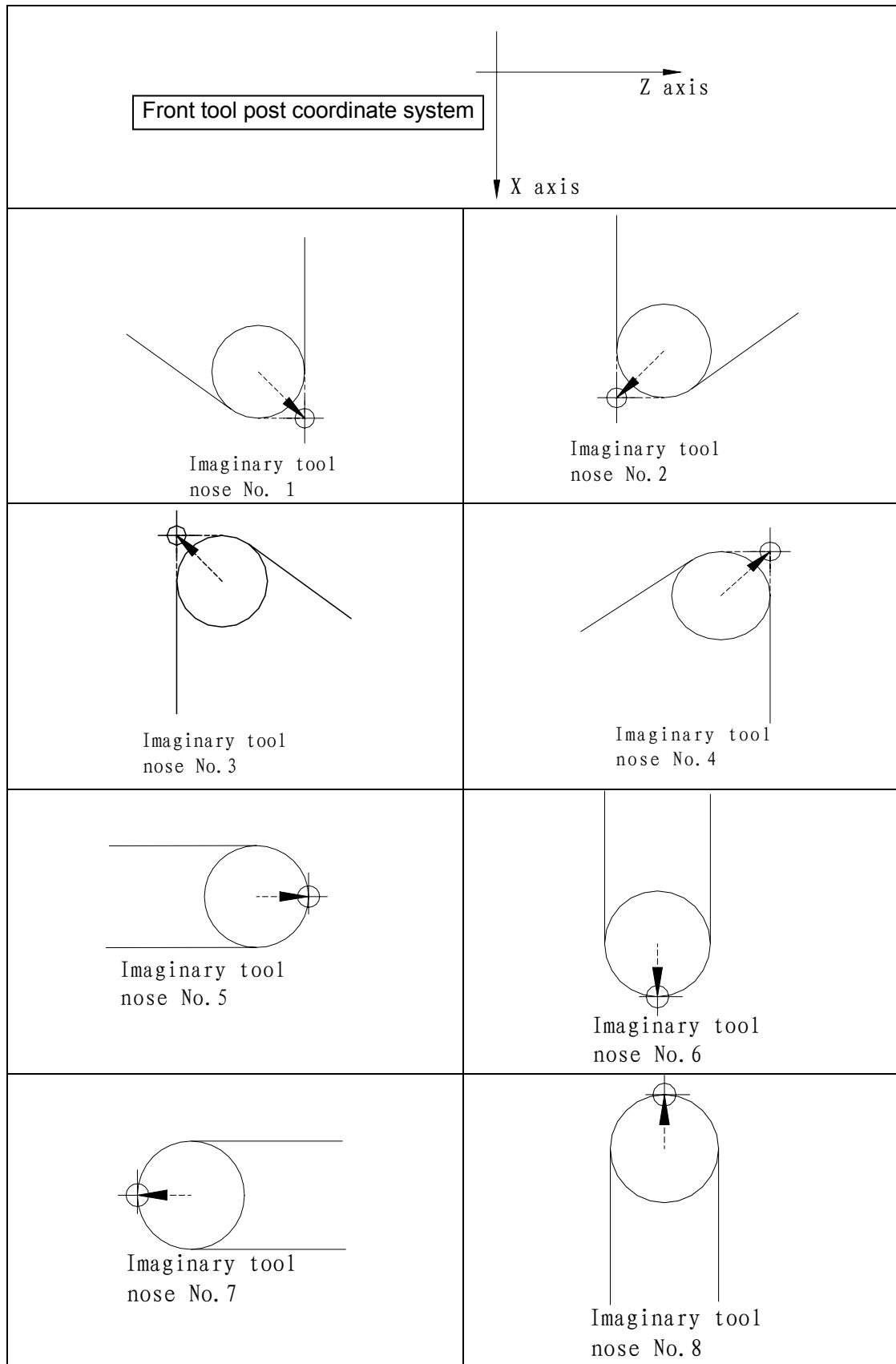

Fig. 4-8 Imaginary tool nose number in front tool post coordinate system

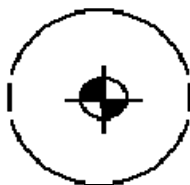

Fig. 4-9 Tool nose center on starting point

### 4.1.3 Compensation value setting

Preset imaginary tool nose number and tool nose radius value for each tool before executing tool nose radius compensation. Set the tool nose radius compensation value in **OFFSET** window (as Fig. 4-1), R is tool nose radius compensation value and T is imaginary tool nose number.

Table 4-1 CNC tool nose radius compensation value display window

number	X	Z	R	T
000	0.000	0.000	0.000	0
001	0.020	0.030	0.020	2
002	1.020	20.123	0.180	3
...	...	...	...	...
032	0.050	0.038	0.300	6

**Note:** X tool offset value can be specified in diameter or radius, set by No.004 Bit4 ORC, offset value is in radius when ORC=1 and is in diameter when ORC=0.

In toolsetting, the tool nose is also imaginary tool nose point of T<sub>n</sub> (n=0~9) when taking T<sub>n</sub>(n=0~9) as imaginary tool nose. For the same tool, offset value from standard point to tool nose radius center (imaginary tool nose is T<sub>3</sub>) is different with that of ones from standard point to imaginary tool nose (imaginary tool nose is T<sub>3</sub>) when T<sub>0</sub> and T<sub>3</sub> tool nose points are selected to toolsetting in rear tool post coordinate system, taking tool post center as standard point. It is easier to measure distances from the standard point to the tool nose radius center than from the standard point to the imaginary tool nose, and so set the tool offset value by measuring distance from the standard point to the imaginary tool nose (tool nose direction of T<sub>3</sub>).

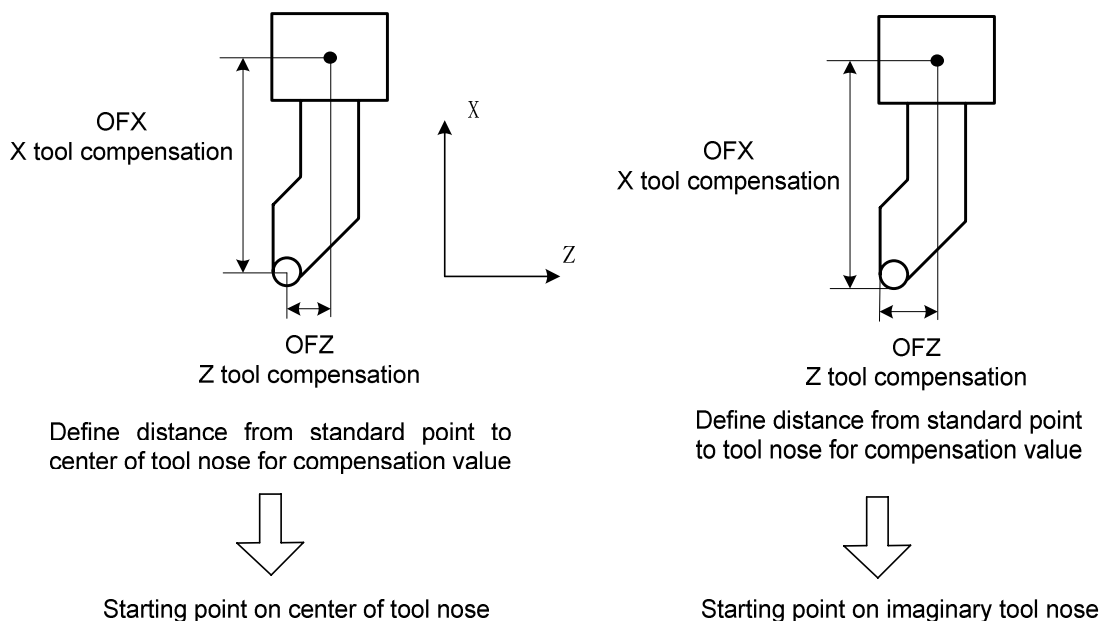

Fig. 4-10 Tool offset value of tool post center as benchmark

### 4.1.4 Command format

$$\left. \begin{matrix} G40 \\ G41 \\ G42 \end{matrix} \right\} \left\{ \begin{matrix} G00 \\ G01 \end{matrix} \right\} X\_ Z\_ T\_ ;$$

Commands	Function specifications	Remark
G40	Cancel the tool nose radius compensation	See Fig.4-11 and 4-12
G41	Tool nose radius left compensation is specified by G41 in rear tool post coordinate system and tool nose radius right compensation is specified by G41 in front tool post coordinate system	
G42	Tool nose radius right compensation is specified by G42 in rear tool post coordinate system and tool nose radius left compensation is specified by G42 in front tool post coordinate system	

### 4.1.5 Compensation direction

Specify its direction according to relative position between tool nose and workpiece when executing tool nose radius compensation is shown in Fig. 4-11 and Fig.4-12.

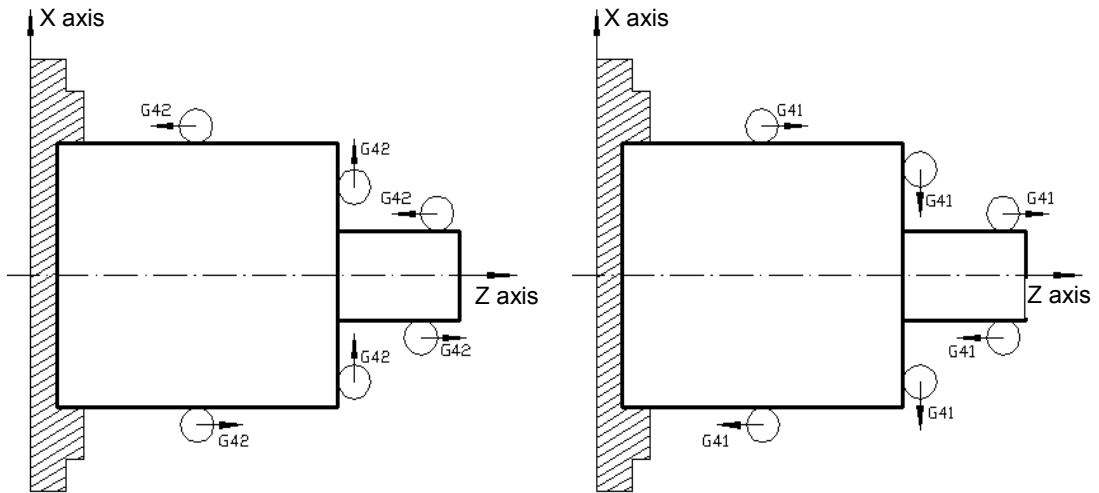
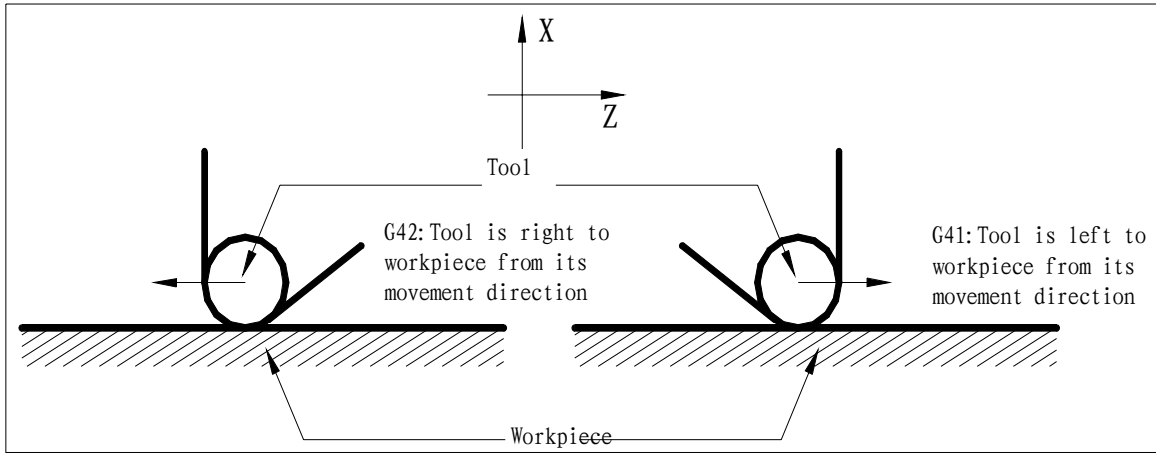

Fig. 4-11 Compensation direction of rear coordinate system



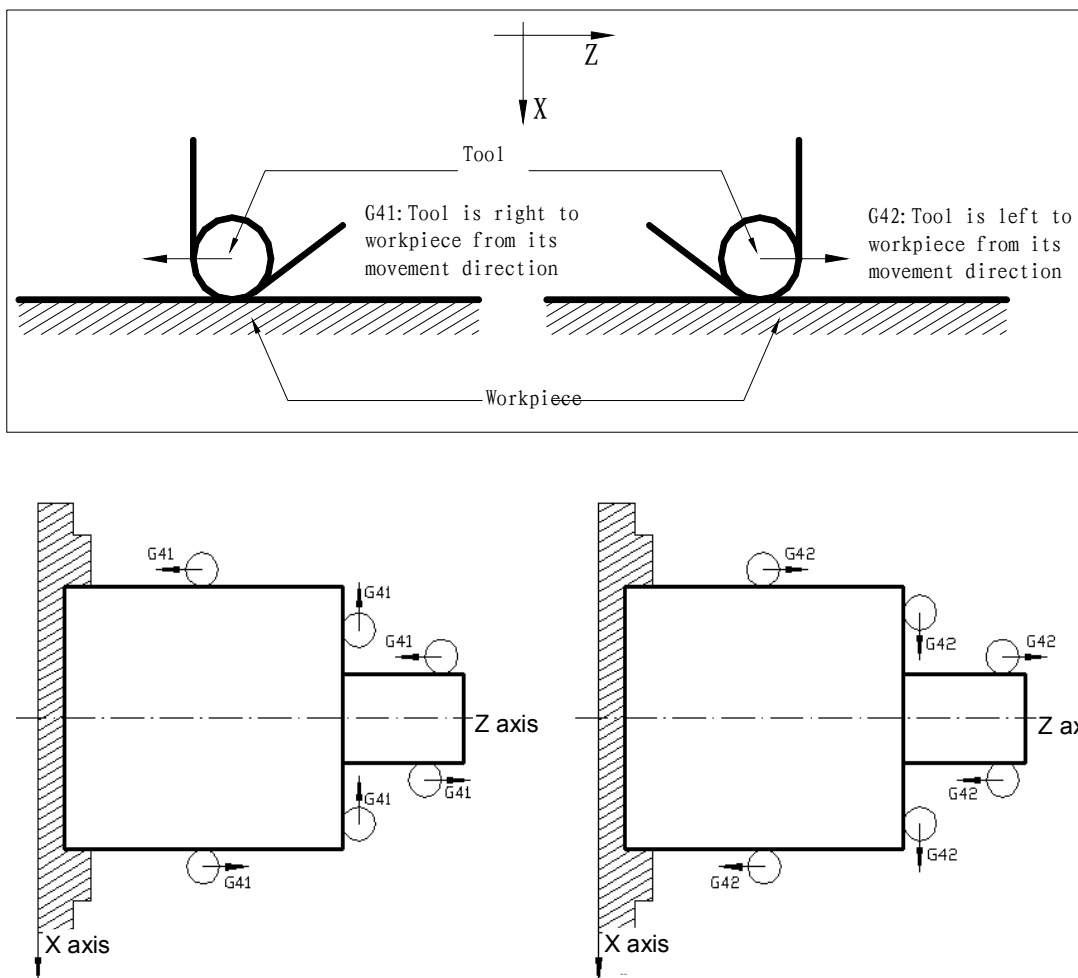



Fig. 4-12 Compensation direction of front coordinate system

4.1.6 Notes

- The system is in tool nose radius compensation mode at initial state, and starts to create tool nose radius compensation offset mode when executing G41 or G42. When the system starts to execute compensation, it pre-read two blocks, and the next block is saved to storage for tool nose radius compensation when executing one of them. The system reads two blocks in **“Single”** mode and stops after executing end point of the first block.
- In tool nose radius compensation mode, the tool nose center moves to end point of previous block and is vertical to its path when the system executes two block or more than blocks without motion Command.
- The system cannot create and cancel tool nose radius compensation.
- Tool nose radius R is without negative value, otherwise there is a mistake running path.
- Tool nose radius compensation is created and cancelled in G00 or G01 instead of G02 or G03, otherwise, the system alarms.
- The system cancels the tool nose radius compensation mode when pressing  key.
- G40 must be specified to cancel offset mode before the program is ended, otherwise the tool path offsets one tool nose radius.
- The system executes the tool nose radius compensation in main program and subprogram but

must cancel it before calling subprogram and then create it again in the subprogram.

- The system does not execute the tool nose radius compensation in G71, G72, G73, G74, G75, G76 and cancel it temporarily.
- The system executes the tool nose radius compensation in G90, G94, it offsets one tool nose radius for G41 or G42.

#### 4.1.7 Application

Machine a workpiece in the front tool post coordinate system as Fig. 4-13. Tool number: T0101, tool nose radius R=2, imaginary tool nose number T=3.

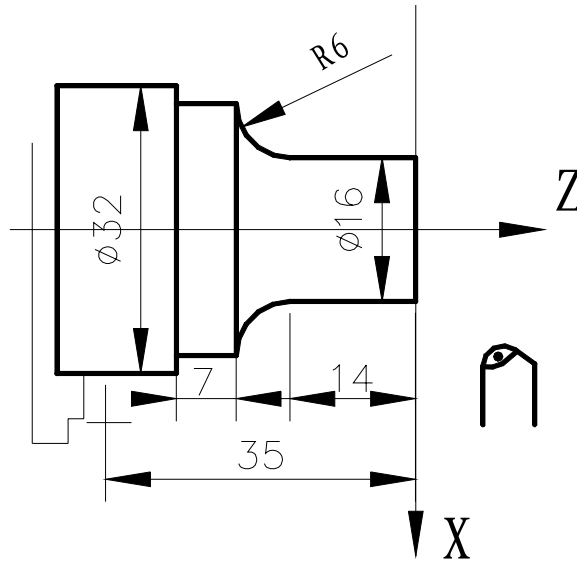

Fig. 4-13

For toolsetting in Offset Cancel mode, after toolsetting, Z axis offsets one tool nose radius and its direction is relative to that of imaginary tool nose and toolsetting point, otherwise the system excessively cuts tool nose radius when it starts to cut.

Set the tool nose radius R and imaginary tool nose direction in “**TOOL OFFSET&WEAR**” window as following:

Table 4-3

No.	X	Z	R	T
001			2.000	3
002	...	...	...	...
...	...	...	...	...
007	...	...	...	...
008	...	...	...	...

Program:

G00 X100 Z50 M3 T0101 S600;

(Position, start spindle, tool change and execute tool compensation)

G42 G00 X0 Z3;

(Set tool nose radius compensation)

G01 Z0 F300;

(Start cutting)

X16;

```
Z-14 F200;
G02 X28 W-6 R6;
G01 W-7;
X32;
Z-35;
G40 G00 X90 Z40;           (Cancel tool nose radius compensation)
G00 X100 Z50 T0100;
M30;
```

## 4.2 Tool Nose Radius Compensation Offset Path

### 4.2.1 Inner and outer side

**Inside** is defined that an angle at intersection of two motion blocks is more than or equal to 180°;  
**Outside** is 0~180°.

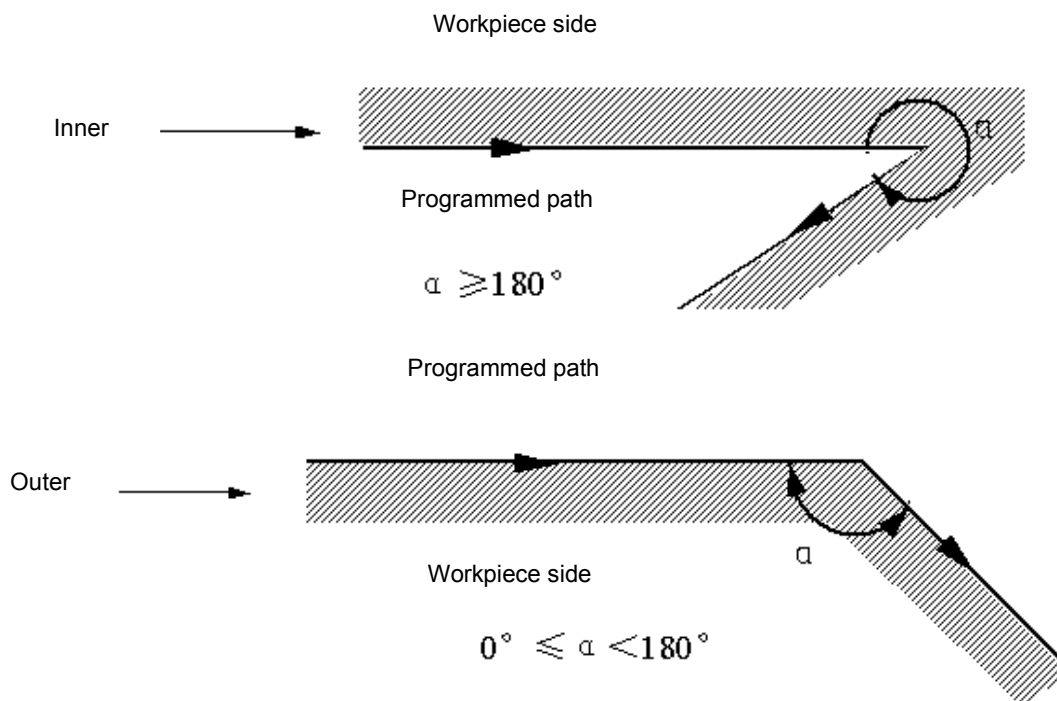

3 steps to execute tool nose radius compensation: tool compensation creation, tool compensation execution and tool compensation canceling.

Tool traverse is called tool compensation creation (starting tool) from offset canceling to G41 or G42 execution.

**Note:** Meanings of S, L, C in the following figures are as follows: S—Stop point of single block; L—linear; C—circular.

**Note:** Tool movement path is marked with the tool nose direction 0 in the following figures.

**Note:** Tool path is described in rear tool post coordinate system and tool compensation direction G41 in the following figures.

4.2.2 Tool traversing when starting tool

(a) Tool traversing inside along corner ( $\alpha \geq 180^\circ$ )

1) Linear  $\rightarrow$  linear

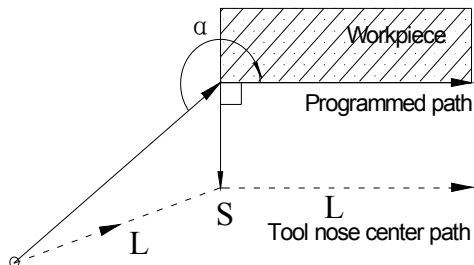

2) linear  $\rightarrow$  circular

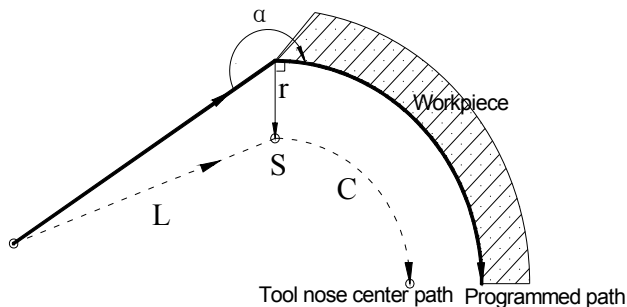

(b) Tool traversing inside along corner ( $180^\circ > \alpha \geq 90^\circ$ )

1) Linear  $\rightarrow$  linear

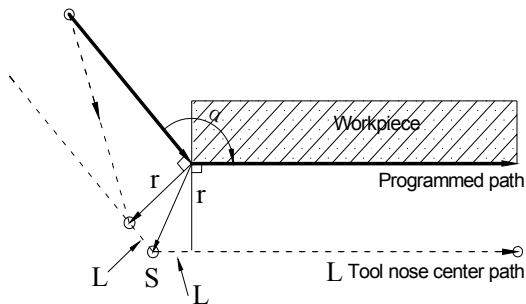

2) linear  $\rightarrow$  circular

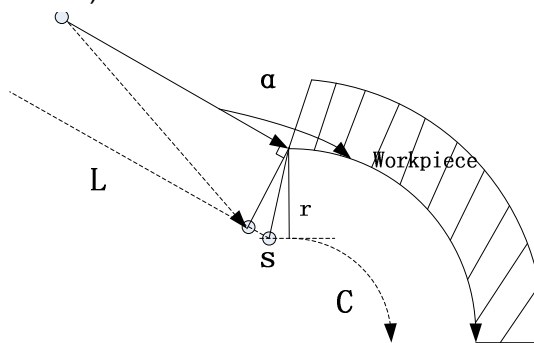

(c) Tool traversing inside along corner ( $\alpha < 90^\circ$ )

1) Linear  $\rightarrow$  linear

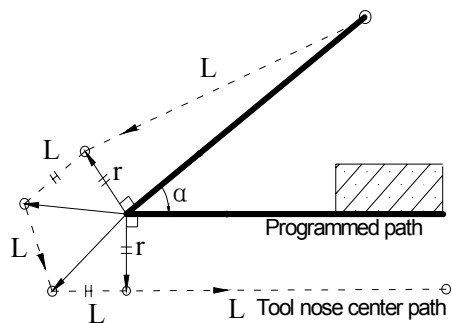

2) Linear  $\rightarrow$  circular

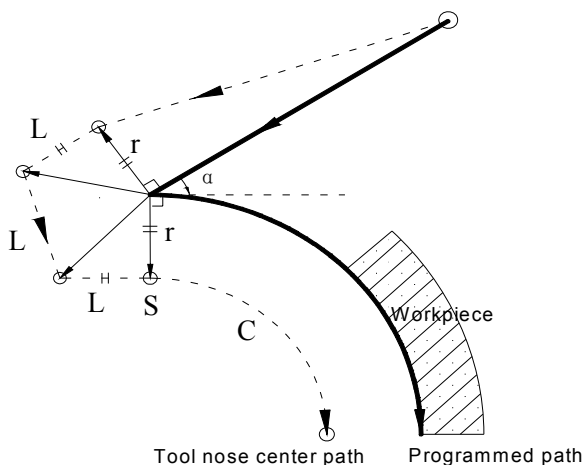

(d) Tool traversing outside along corner , linear →linear ( $\alpha \leq$  angle set by No. 237)

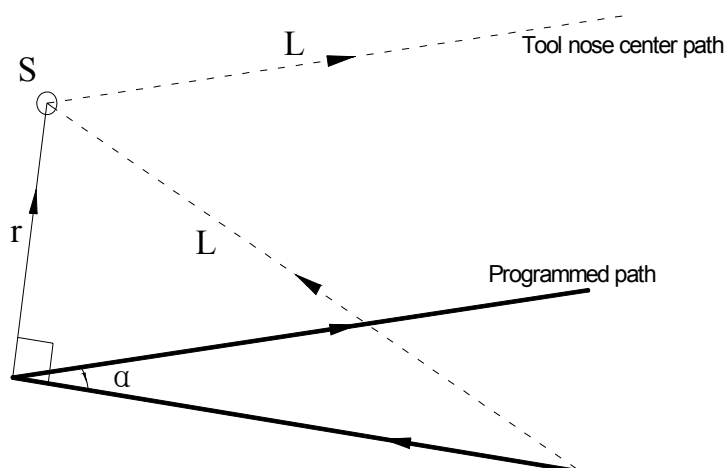

4.2.3 Tool traversing in Offset mode

Offset mode is called to ones after creating tool nose radius compensation and before canceling it.

- Offset path without changing compensation direction in compensation mode

(a) Tool traversing inside along corner ( $\alpha \geq 180^\circ$ )

1) Linear → linear

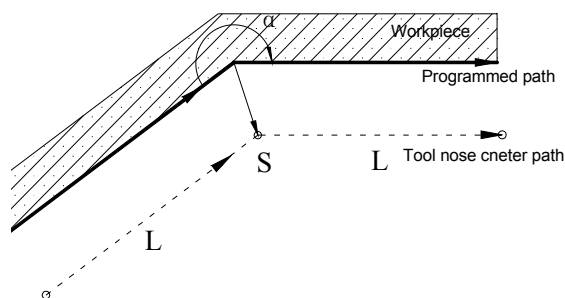

2) Linear → circular

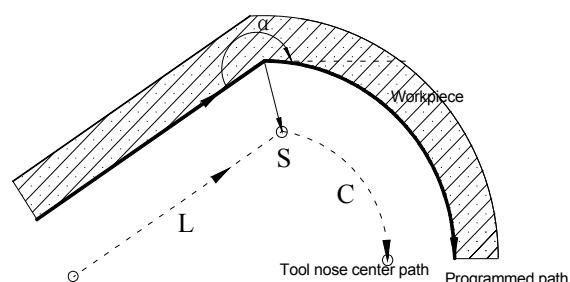

3) Circular → linear

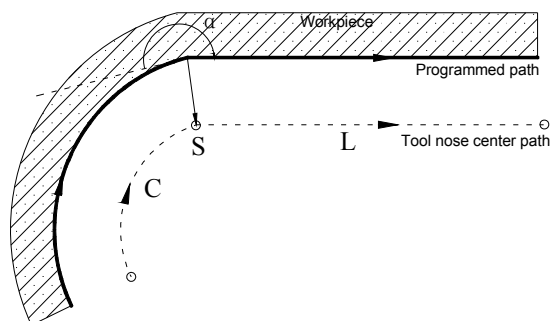

4) Circular → circular

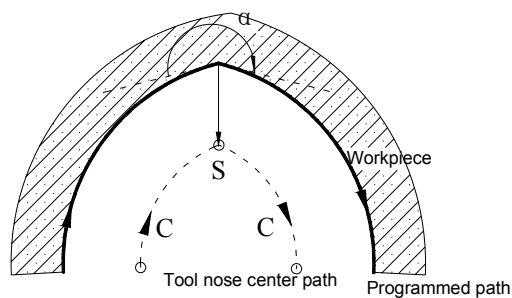

(b) Tool traversing outside along corner ( $180^\circ > \alpha \geq 90^\circ$ )

1) Linear → linear

2) Linear → circular

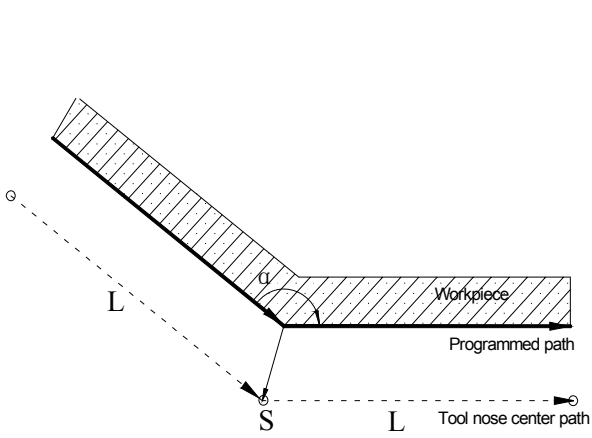

3) Circular→Linear

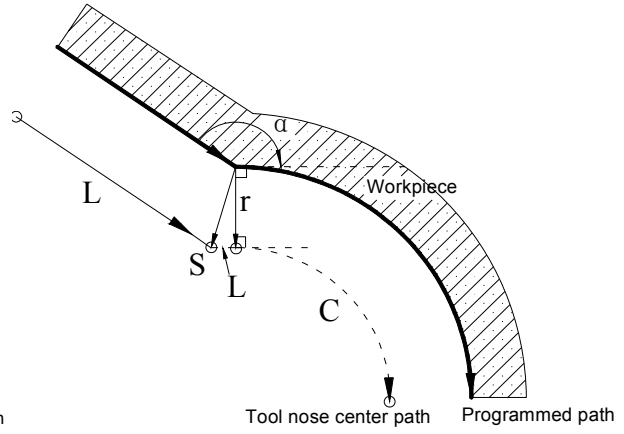

4) Circular→Circular

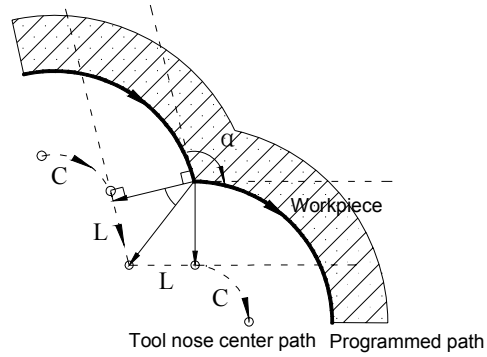
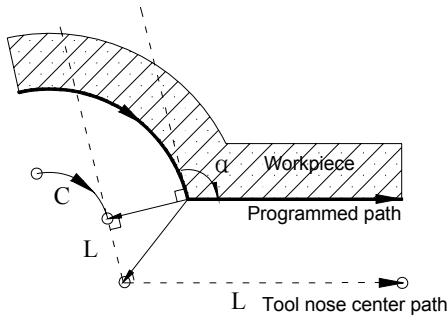

**(c) Tool traversing outside along corner ( $\alpha < 90^\circ$ )**

1) Linear→linear

2) linear→circular

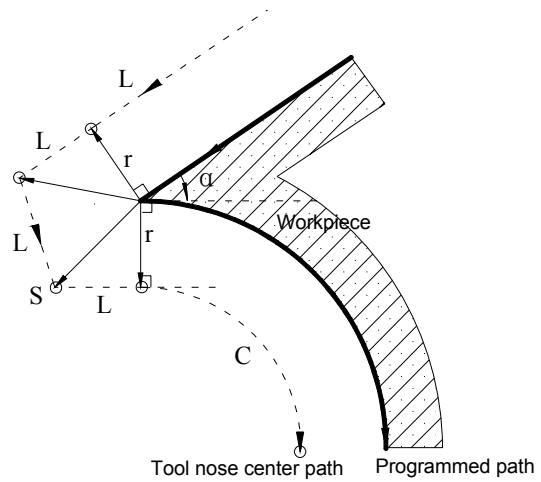
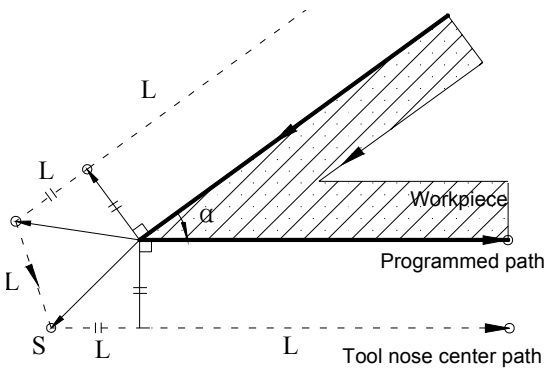

3) Circular→linear

4) Circular→circular

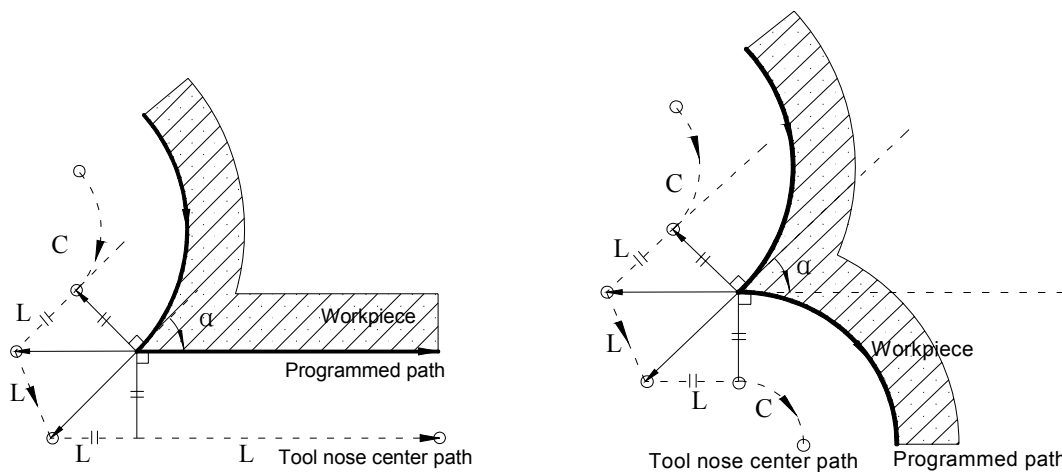

5) Inner side machining and scaling up compensation valid for acute angled being less than  $\alpha$  ( $\alpha$ : set by No. 237).

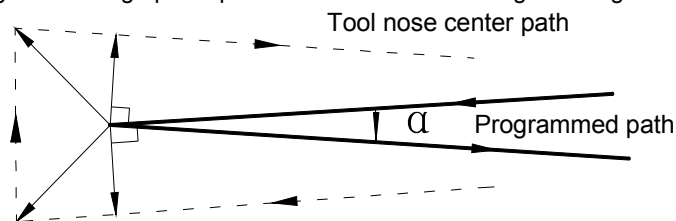

**(d) Special cutting**

1) Without intersection

Tool nose radius is big ( $r2$ ):

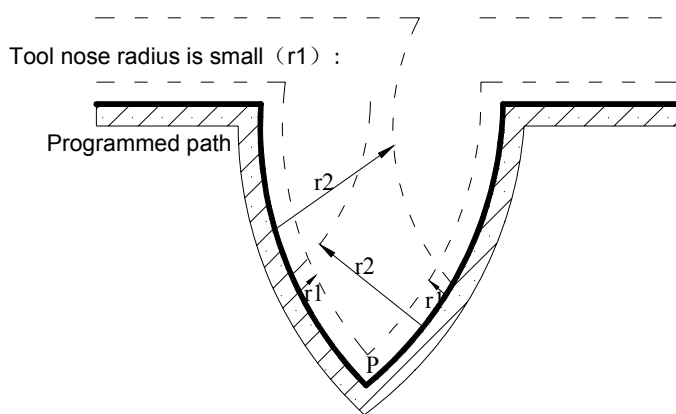

There is an intersection P between arc and arc compensation path when the tool radius is small; none when the radius is big, and the system alarms.

Fig. 4-14 Paths without intersection after offset

● **Offset path of changing compensation direction in compensation mode**

The compensation direction can be changed in compensation mode in special cutting. There is no inside and outside cutting when the system changes the compensation direction. The following are the path of tool running when the compensation changes are changed:

- 1) Linear → linear
- 2) Linear → circular

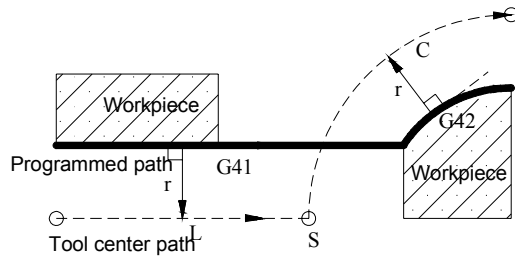
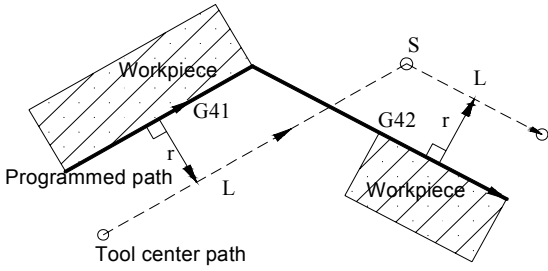

3) Circular→linear

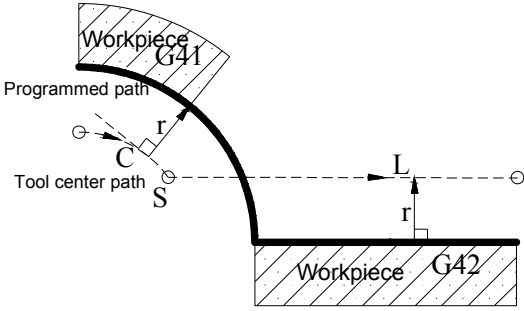

4) Circular→circular

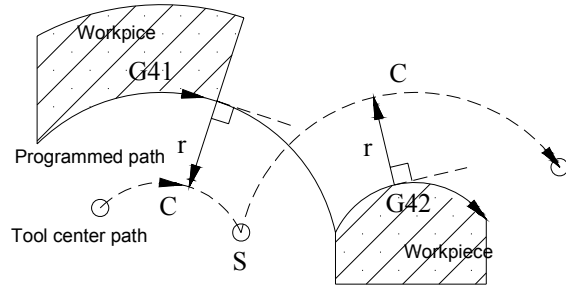

5) No intersection when compensation is executed normally

When the system executes G41 and G42 to change the offset direction between block A and B, a vector perpendicular to block B is created from its starting point.

i) Linear---Linear

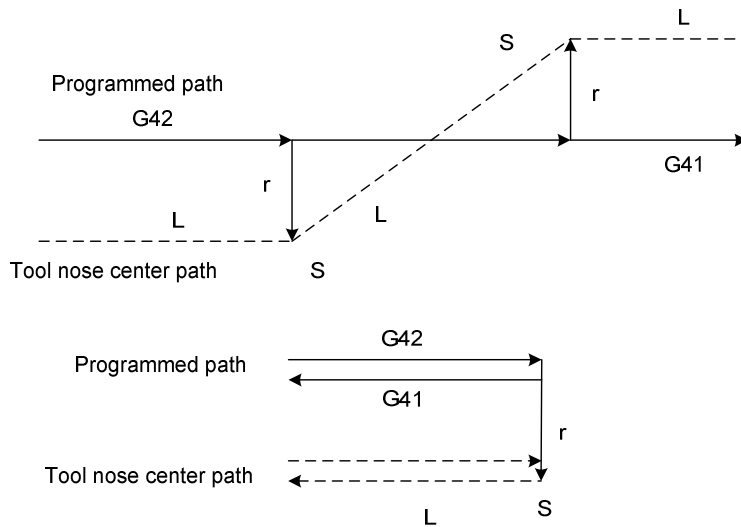

Fig. 4-15a Linear—linear, no intersection (changing compensation direction)

ii) Linear ---circular



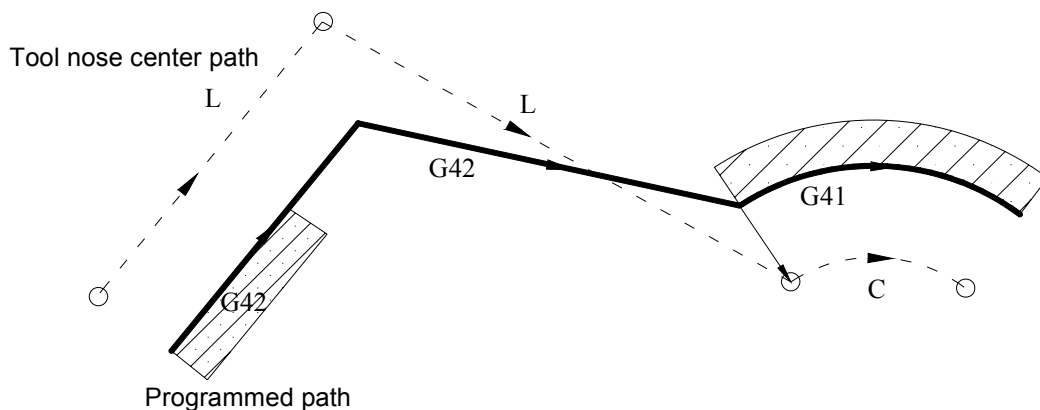

Fig. 4-15b Linear—circular without intersection (changing compensation direction)

iii ) Circular----circular

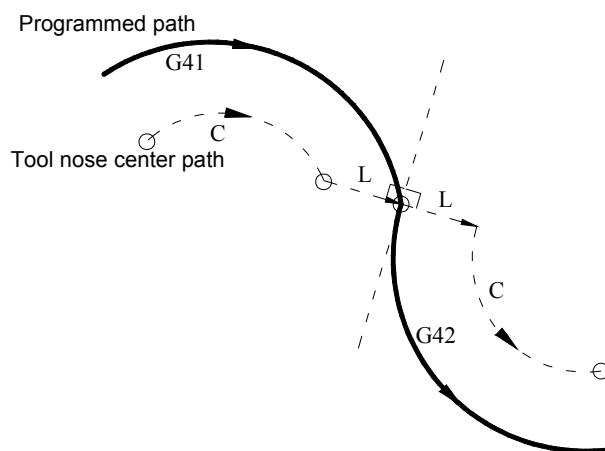

Fig. 4-15c Circular—circular without intersection (changing compensation direction)

4.2.4 Tool traversing in Offset canceling mode

In compensation mode, when the system executes a block with one of the followings, it enters compensation canceling mode, which is defined to compensation canceling of block.

1. Execute G40 in a program;
2. Execute M30.

The system cannot execute G02 and G03 when canceling C tool compensation (tool nose radius compensation), otherwise the system alarms and stops run.

In compensation canceling mode, the system executes the block and ones in the register for tool nose radius compensation. At the moment, the run stops after one block is executed when single block is ON. The system executes the next one but does not read its following one when pressing **CYCLE START** button again.

(a) Tool traversing inside along corner( $\alpha \geq 180^\circ$ )

- 1) Linear→linear
- 2) Circular→linear

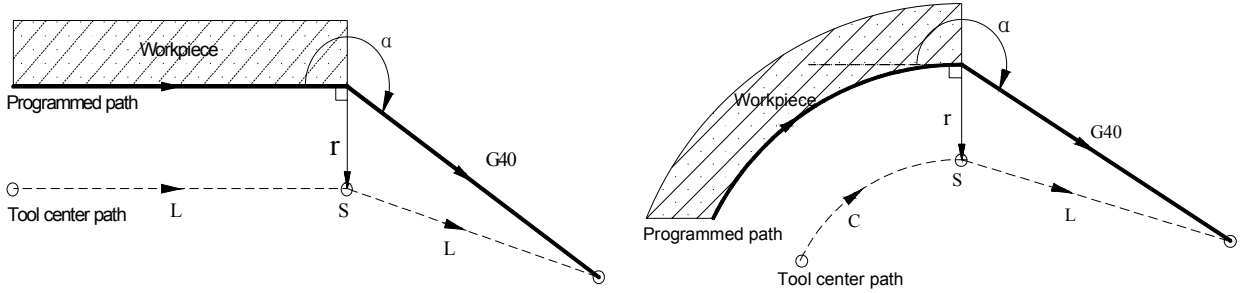

**(b) Tool traversing outside along corner ( $180^\circ > \alpha \geq 90^\circ$ )**

1) Linear→linear

2) Circular→linear

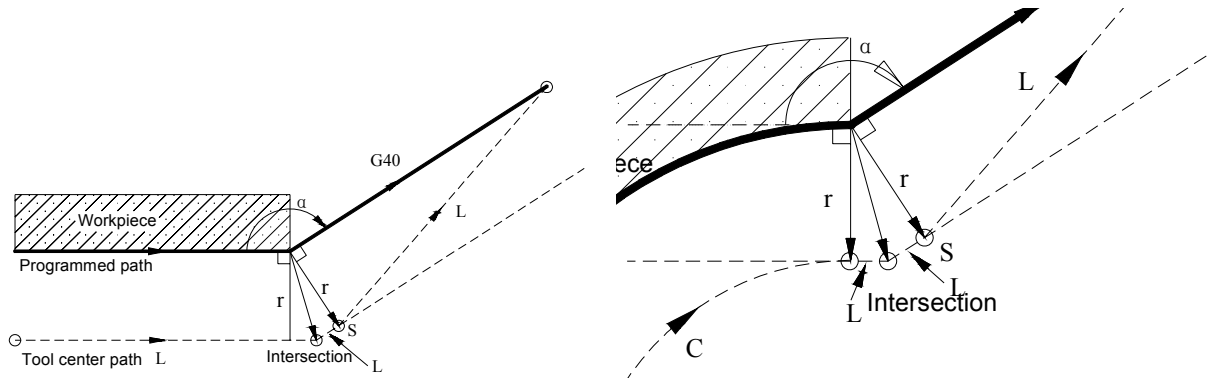

**(c) Tool traversing outside along corner ( $\alpha < 90^\circ$ )**

1) Linear→linear

2) Circular→linear

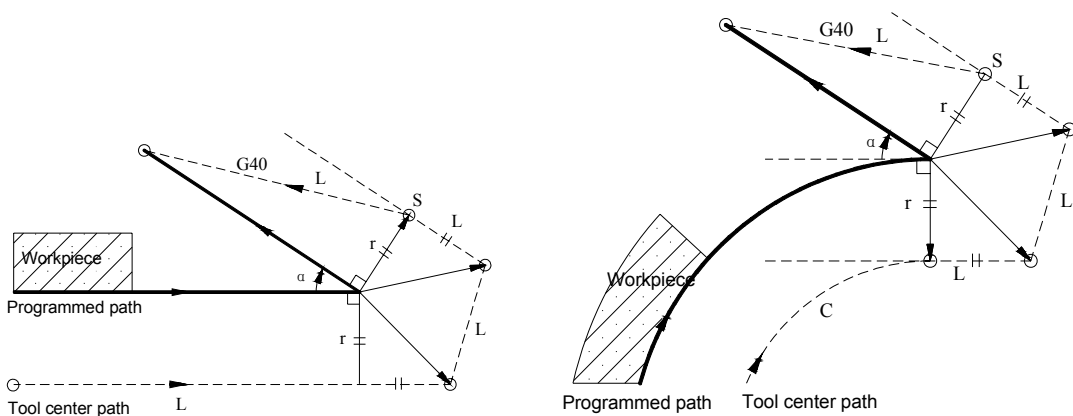

**4.2.5 Tool interference check**

“Interference” is defined that the tool cuts workpiece excessively and it can find out excessive cutting in advance, the interference check is executed even if the excessive cutting is not created, but the system cannot find out all tool interferences.

**(1) Fundamental conditions**

- 1) The tool path direction is different that of program path (angle is  $90^\circ \sim 270^\circ$ ).
- 2) There is a big difference ( $\alpha > 180^\circ$ ) for two angles between starting point and end point of tool nose center path, and between starting point and end point of program path.

Example: linear machining

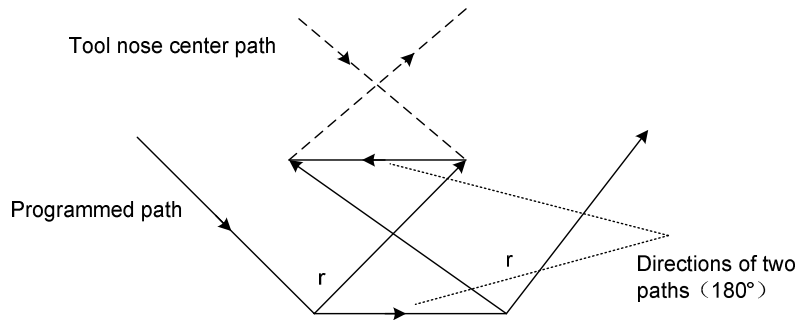

Fig. 4-16a Machining interference (1)

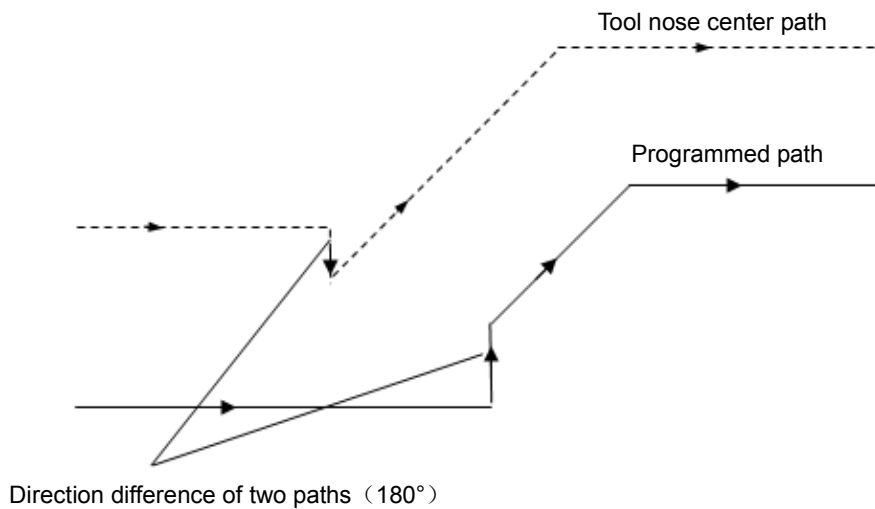

Fig. 4-16b Machining interference (2)

**(2) Executing it without actual interference**

1) Concave groove less than compensation value

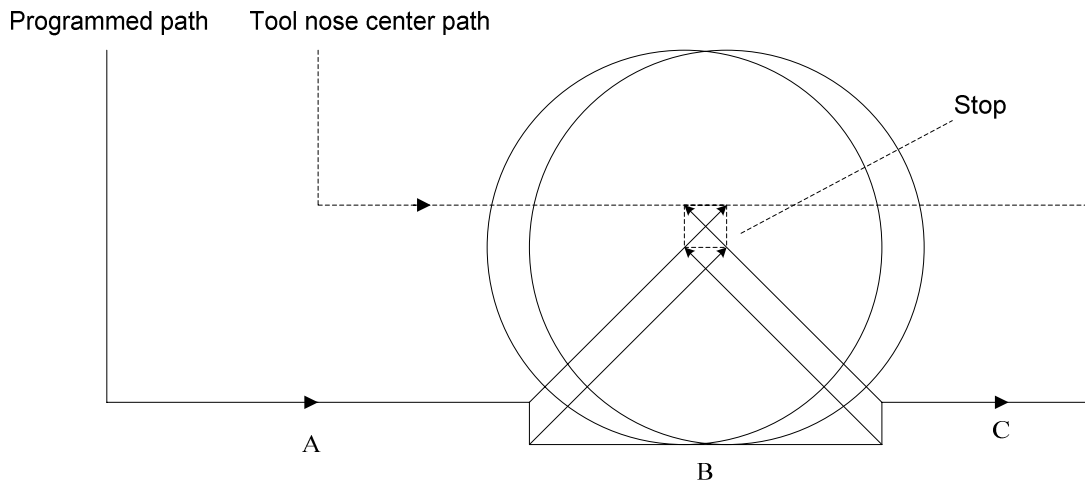

Fig. 4-17 Executing interference (1)

Directions of block B and tool nose radius compensation path are opposite without interference, the tools stops and the system alarms.

2) Concave channel less than compensation value

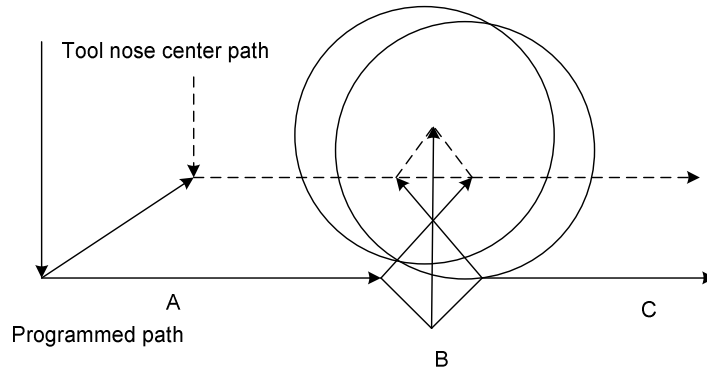

Fig. 4-18 Executing interference (2)

Directions of block B and tool nose radius compensation path are opposite without interference, the tools stops and the system alarms.

**4.2.6 Commands for canceling compensation vector temporarily**

In compensation mode, the compensation vector is cancelled temporarily in G50, G71~G76 and is automatically resumed after executing the commands. At the moment, the compensation is cancelled temporarily and the tool directly moves from intersection to a point for canceling compensation vector. The tool directly moves again to the intersection after the compensation mode is resumed.

● **Setting coordinate system in G50**

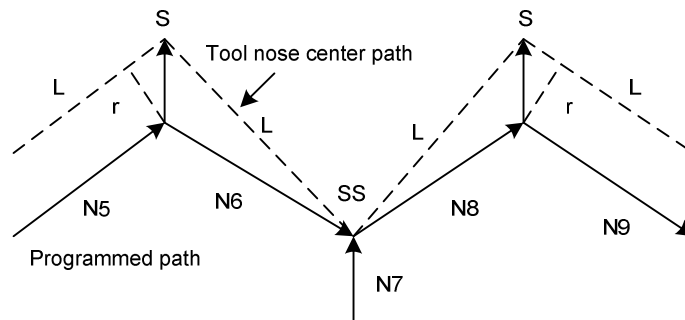

Fig. 4-19 Temporary compensation vector in G50

Note: SS indicates a point at which the tool stops twice in Single mode.

● **Reference point automatic return G28**

In compensation mode, the compensation is cancelled in a middle point and is automatically resumed after executing the reference point return in G28.

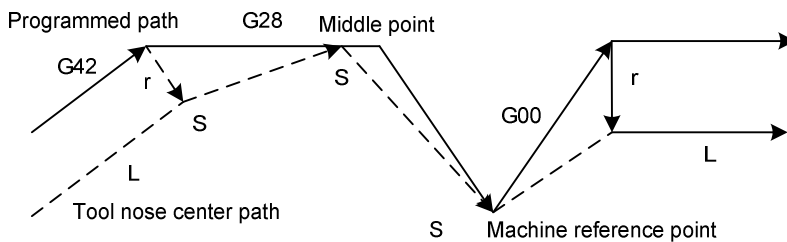

Fig. 4-20 Cancel compensation vector temporarily in G28

● **G71~G75 compound cycle; G76, G92 thread cutting**

When executing G71~G76 , G96 thread cutting, the system does not execute the tool nose

radius compensation and cancel it temporarily, and there is G00, G01, in the following blocks, and the system automatically recovers the compensation mode.

● **G32, G33, G34 thread cutting**

They cannot run in the tool nose radius compensation mode, otherwise, No.131 alarm occurs “.....CANNOT USED TO C COMPENSATION”.

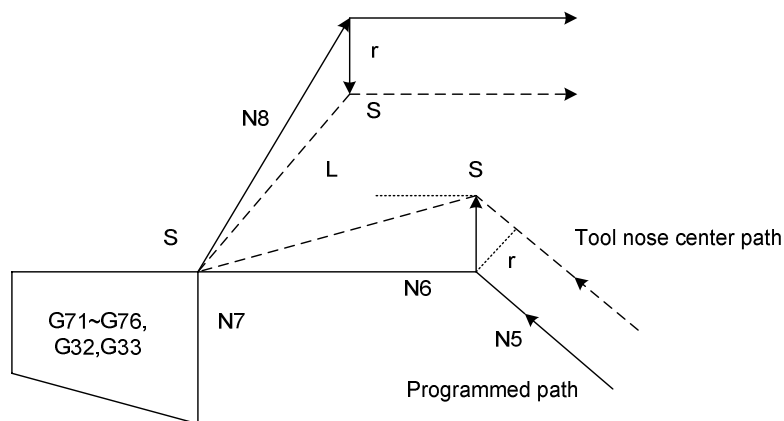

Fig. 4-21 Cancel compensation vector temporarily in G71~G76

● **G32, G33, G34 constant thread cutting**

They cannot be executed in tool nose radius compensation mode, otherwise, No. 131 alarm occurs “.....the command cannot be used in C compensation mode.”

● **G90, G94 (taking an example of G42)**

Compensation method of tool nose radius compensation in G90 or G94:

- A. Cancel the previous tool nose radius compensation;
- B. Create the previous C compensation before cutting, and the path ① in the following figure creates the previous radius compensation mode;
- C. The paths 2, 3 in the following figure are the radius compensation cutting;
- D. The path 4 in the following figure can cancel the radius compensation, and the tool returns to the cycle starting point; there is G00, G01 in the following block, and the CNC automatically recovers the compensation mode.

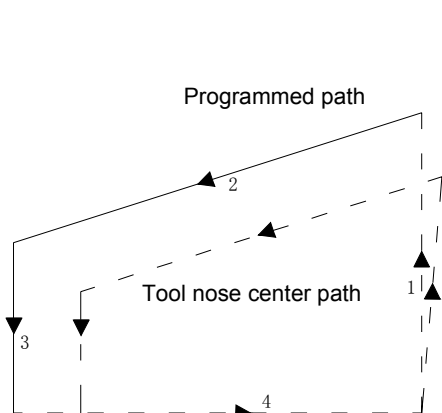

Fig. 4-22 Offset direction of G90 tool nose radius compensation

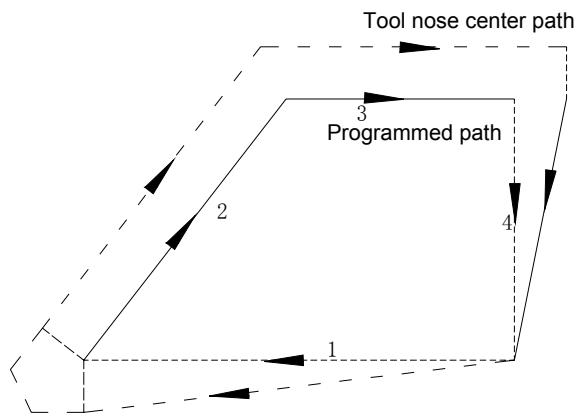

Fig. 4-23 Offset direction of G94 tool nose radius compensation



# II Operation

---





# CHAPTER 1 OPERATION MODE AND DISPLAY INTERFACE

## 1.1 Panel Division

GSK980TDc, GSK980TDc-V CNC system uses an integrated panel, which is divided as follows:



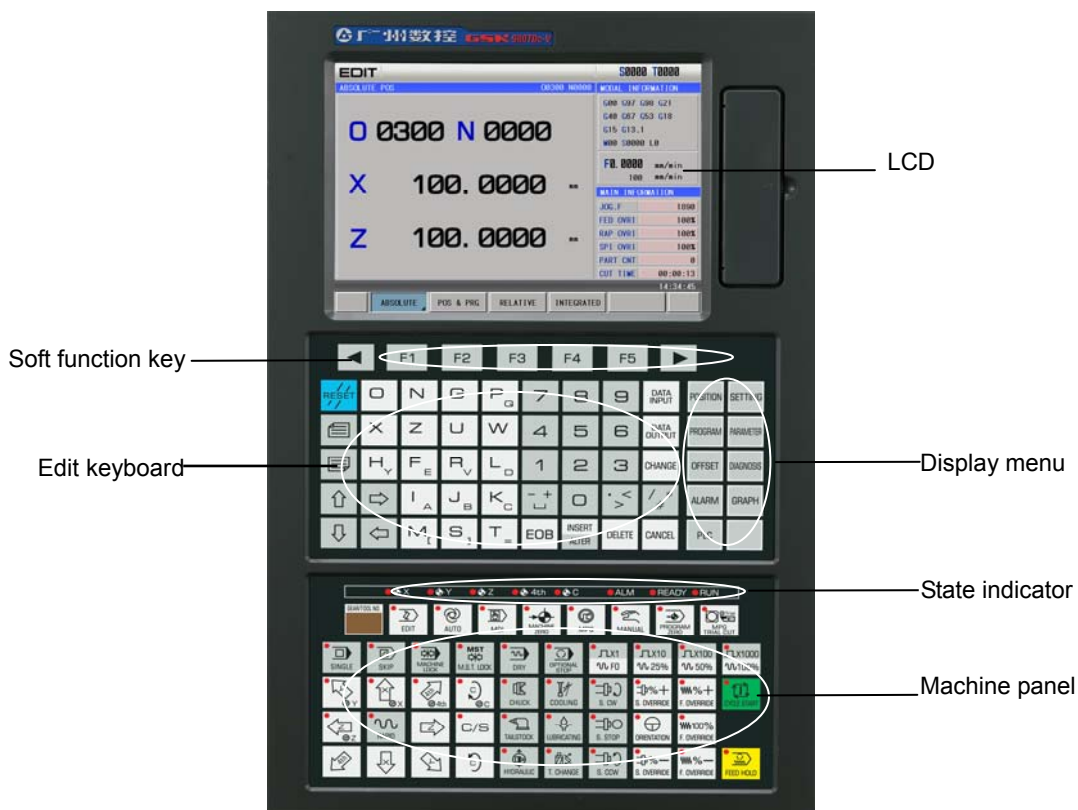

GSK980TDc panel division











GSK980TDc-V panel division

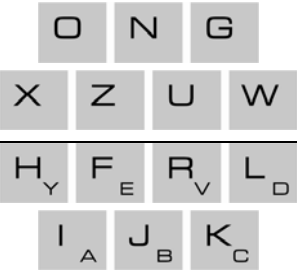
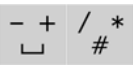
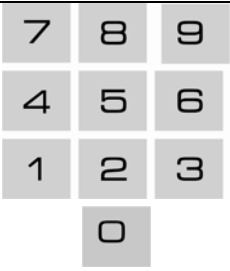

II Operation

### 1.1.1 State indication



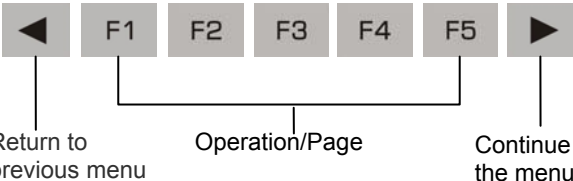

	Indicator for axis zero return completion
	Three-color light

### 1.1.2 Edit keypad

Press key	Name	Function
	RESET key	CNC reset, feed, output stop etc.
	Address key	Address input  Double address key, switching them by pressing it repetitively
	symbol	Key to three addresses,, switching them by pressing it repetitively
	Number key	Number input
	Decimal point	Decimal point input
	Input key	Parameter, compensation value and other data input
	Output key	Communication output
	Change key	Switching message, display
	Edit key	Inserting, altering, deleting programs, fields in EDIT working mode(  compound key, switching them by pressing it repetitively)
	EOB key	Inputting the end character of block
	Cursor move keys	controlling cursor move

Press key	Name	Function
	Window key	Switch the page in the same display page
	Soft function key	<p>After using function keys to switch page collection, the soft function keys are used to display the content of some subpage in the current page collection, which is shown below:</p>  <p>Soft function keys:</p> <ol style="list-style-type: none"> <li>① Switch subpage in current page collection;</li> <li>② Operations in currently displayed subpage include editing, modifying data or displaying content.</li> </ol>

### 1.1.3 Menu display





Menu key	Remark
	<p>To enter Position interface including RELATIVE POS, ABSOLUTE POS, POS &amp; PRG, INTEGRATED POS page.</p> <ul style="list-style-type: none"> <li>● “ABSOLUTE POS” page can display the current absolute coordinates, clear out machining count, machining time;</li> <li>● “POS &amp; PRG” page can display current coordinate information and current run program;</li> <li>● “RELATIVE POS” page can display current relative coordinates, clear relative coordinates;</li> <li>● “INTEGRATED POS” can display current coordinate information and clear machine coordinates</li> </ul>
	<p>To enter Program interface including program content, program list, program state page</p> <ul style="list-style-type: none"> <li>● Edit/search current open programs in program content page;</li> <li>● Edit MDI programs, display coordinates, override and modal state in MDI page;</li> <li>● Display, preview, open, copy machining programs in CNC in local catalog page;</li> <li>● Display, preview, open and copy machining programs in U disk in U disk catalog page</li> </ul>
	<p>Enter tool offset interface including offset setting, macro variables, workpiece coordinate system and tool life page</p> <ul style="list-style-type: none"> <li>● Set/search tool offset value and wear value in tool offset setting page;</li> <li>● Set/search CNC macro variables in macro variable page;</li> <li>● Set/search G54~G59 coordinate system and zero offset value in workpiece coordinate system page;</li> <li>● Set/search use information of current tool life</li> </ul>
	<p>Enter alarm interface including alarm information, alarm log page</p> <ul style="list-style-type: none"> <li>● Search CNC alarm, CNC warning, PLC alarm, PLC warning in alarm information page;</li> </ul>

















	<ul style="list-style-type: none"> <li>● Display alarm/warning history record in alarm log page</li> </ul>
SETTING	<p>Enter Setting interface including CNC setting, system clock, file management page</p> <ul style="list-style-type: none"> <li>● Set switch, level and parameters in CNC setting page;</li> <li>● Set system clock, data in system clock page;</li> <li>● Search/management files in CNC/U disk, copy/resume files in file management page</li> </ul>
PARAMETER	<p>Enter Parameter interface including state parameters, data parameter, often used parameters and pitch compensation page.</p> <ul style="list-style-type: none"> <li>● Search/set state parameters in the state parameter page;</li> <li>● Search/set data parameters in the data parameter page;</li> <li>● Search/set user's customized parameters in the often used parameter page;</li> <li>● Search/set pitch error compensation data of each axis in the pitch compensation page.</li> </ul>
DIAGNOSIS	<p>Enter Diagnosis interface including the system diagnosis, system information page</p> <ul style="list-style-type: none"> <li>● Search the current diagnosis information of the CNC in the diagnosis page.</li> <li>● Search the product information, ladder information and ladder state.</li> </ul>
PLC	<p>PLC page includes three subpages: PLC state, PLC monitor, PLC data.</p> <ul style="list-style-type: none"> <li>● PLC state page can search states of X, Y, F, G, R, A, C, T;</li> <li>● PLC monitor page can monitors the execution state of current ladder on-line;</li> <li>● PLC data page can search/set K, D, DT, DC value.</li> </ul>
GRAPH	<p>Enter Graph page to display the movement path of X, Z axis</p>













### 1.1.4 Machine panel

The key functions on GSK980TDC machine panel are defined by PLC program (ladder), the detailed function meanings are referred to machine manufacturer manual.

The functions of this GSK980TDC machine panel keys defined by standard PLC program are as follows:

Key	Name	Function explanation	Operation mode
	Feed hold key	Dwell commanded by program, MDI code	Auto, MDI mode
	Cycle Start key	Cycle start commanded by program, MDI code	Auto, MDI mode
	Feedrate Override keys	Adjusting feedrate	Auto, MDI, Edit, Machine zero return, MPG, Step, Manual, Program zero return mode
	Rapid override keys	Adjusting rapid traverse	Auto, MDI, Machine zero return, Manual, Program zero return mode
	Spindle override keys	spindle speed adjustment (spindle analog control active)	Auto, Edit, MDI, Machine zero return, Manual, Step, MPG, Program zero return mode

Key	Name	Function explanation	Operation mode
	Manual tool change key	manual tool change	Machine zero return, Manual, Step, MPG, Program zero return mode
	JOG key	spindle jog on/off	Machine zero return, Manual, Step, MPG, Program zero return mode
	C/S Switch	switch spindle speed/ position control	
	Lubricating key	For lubricating ON/OFF	
	Cooling key	For cooling ON/OFF	Auto, Edit, MDI, Machine zero return, Manual, Step, MPG, Program zero return mode
	Chuck key(980TDc -V)	Chuck clamping/releasing	Auto, Edit, MDI, Machine zero return, Manual, Step, MPG, Program zero return mode
	Hydraulic key(980TDc -V)	Hydraulic output ON/OFF	Auto, Edit, MDI, Machine zero return, Manual, Step, MPG, Program zero return mode
	Spindle control keys	For spindle CCW For spindle stop For spindle CW	Machine zero return, Manual, Step, MPG, Program zero return mode
	Rapid traverse key	For rapid traverse /feedrate switching	Auto, MDI, Manual mode
	X feed key	Positive/negative movement of each axis in Manual, Step mode	Machine zero return, Step, Manual, Program zero return mode
	Z feed key		
	Y feed key		
	The 4 <sup>th</sup> feed key		
	Cs feed key		
	MPG axis selection key	Each axis selection in MPG mode	MPG mode
	MPG/Step increment and Rapid override selection key	Move amount per MPG scale 0.001/0.01/0.1 mm Move amount per step 0.001/0.01/0.1 mm Rapid override F0, F50%, F100%	Auto, MDI, Machine zero return, Manual, Step, MPG, Program zero return mode
	Optional stop	Execute M01 to pause when the optional stop is	Auto, MDI, and MPG trial-cut mode

Key	Name	Function explanation	Operation mode
		enabled	
	Single Block switch	For switching of block/blocks execution, Single block indicator lights up if Single mode is active	Auto, MDI mode
	Block Skip switch	For skipping of block headed with "T" sign, if its switch is set for ON, the Block Skip indicator lights up	Auto, MDI mode
	Machine Lock key	If the machine is locked, its indicator lights up, and X, Z axis output is inactive.	Auto, MDI, Edit, Machine zero return, Manual, Step, MPG, Program zero return mode
	M.S.T. Lock key	If the miscellaneous function is locked, its indicator lights up and M, S, T function output is inactive.	Auto, MDI mode
	Dry Run key	If dry run is active, the Dry run indicator lights up. Dry run for program/MDI codes	Auto, MDI mode
	Edit mode key	To enter Edit mode	Auto, MDI, Machine zero return, Manual, Step, MPG, Program zero return mode
	Auto mode key	To enter Auto mode	MDI, Edit, Machine zero return, Manual, Step, MPG, Program zero return mode
	MDI mode key	To enter MDI mode	Auto, Edit, Machine zero return, Manual, Step, MPG, Program zero return mode
	Machine zero return mode key	To enter Machine zero return mode	Auto, MDI, Edit, Manual, Step, MPG, Program zero return mode
	Step/MPG mode key	To enter Step or MPG mode (one mode by parameter)	Auto, MDI, Edit, Machine zero return, Manual, Program zero return mode
	Manual mode key	To enter Manual mode	Auto, MDI, Edit, Machine zero return, Step, MPG, Program zero return mode
	Program zero return mode key	To enter Program zero return mode	Auto, MDI, Edit, Machine zero return, Step, MPG, Manual mode
	MPG trial-cut selection key	To enter MPG trial-cut mode	Auto, MDI, Edit, Machine zero return, Step, MPG, Manual, MPG trial-cut mode

## 1.2 Summary of Operation Mode

There are 8 modes in GSK980TDc, which are Edit, Auto, MDI, Machine zero, Step/MPG, Manual, Program Zero, and MPG trial-cut modes.

- **Edit mode**  
In this mode, the operation of part program setup, deletion and alteration can be performed.
- **Auto mode**  
In this mode, the program is executed automatically.
- **MDI mode**  
In this mode, the operation of parameter input, command blocks input and execution can be performed.
- **Machine zero mode**  
In this mode, the operation of X, Z machine zero return can be performed separately.
- **MPG / Step mode**  
In the Step/MPG feed mode, the moving is performed by an increment selected by CNC system.
- **Manual mode**  
In this mode, the operation of Manual feed, Manual Rapid, feedrate override adjustment, Rapid override adjustment and spindle ON/OFF, cooling ON/OFF, Lubricating ON/OFF, spindle jog, manual tool change can be performed.
- **Program zero return mode**  
In this mode, the operation of X, Z program zero return can be performed separately.
- **MDP trail-cut mode**  
In this mode, rotating the MPG can control program's execution speed, which can check whether the machining program is correct.

## 1.3 Display Interface

The chapter introduces page switch, relationship between operation input and soft key, and concrete operation methods.

GSK980TDc has 9 function keys including POS, PRG, SET, etc. on its edit keyboard. Each function key corresponds to one interface which has many pages and operation soft keys, which are shown below:

### 1.3.1 POS interface

Press **POSITION** to enter POS interface which includes pages **ABSOLUTE**, **RELATIVE**, **INTEGRATED** and **POS & PRG**, and these pages can be viewed by corresponding soft function key or repetitively press **POSITION**.

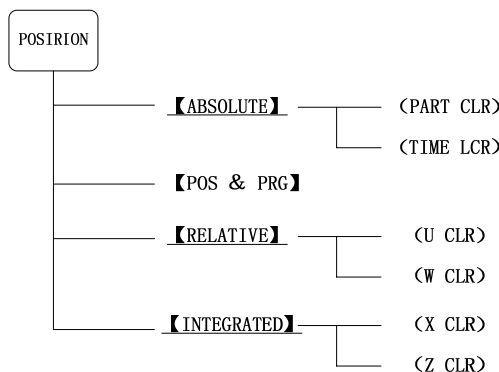

1) ABSOLUTE POS display interface

The X, Z coordinates displayed are the absolute position of the tool in current workpiece coordinate system, these coordinates are memorized as power is down and the workpiece coordinate system is specified by G50.

II Operation



Basic information in POSITION interface (taking an example of the above figure):

- ✓ G code : information of each G code;
- ✓ M : last executed M code;
- ✓ S : it is input spindle speed when analog spindle is executed, and input spindle's gear when the spindle is executed;
- ✓ L : call times of subprogram;
- ✓ F : the first half (0.0000mm/min) is the actual speed, and the second half (200mm/min) is the command speed;
- ✓ JOG F.( JOG speed): theory speed value of current override in JOG mode;
- ✓ FED OVRI(Feedrate override):override selected by feedrate override switch;
- ✓ RAD OVRI (Rapid override): display currently rapid override;
- ✓ SPI OVRI (Spindle override): display the spindle override when NO.001 Bit1 is set to 1;
- ✓ PART CNT(Part counting) : part counting adds 1 when M30 (M99 in the main program) is executed;
- ✓ CUT TIME: the system counts the time when the automatic run is started, time unit is hour, minute and second in order.

The part counting and cut time are memorized at power-down, the clearing ways for them are shown below:

Method 1:



Press **ABSOLUTE** and the following interface appears:



At the moment, press **W CLR** to clear part count, press **TIME CLR** to clear the cut time;

Method 2:

Directly press to enter the absolute coordinate page, at the moment, press **CANCEL** + **N**

to clear part counting, simultaneously press **CANCEL** + **T =** to clear the cut time.

## 2) RELATIVE POS display interface

Displayed U, W coordinates are the current position relative to the relative reference point, and they are held on when power on. They can be cleared at any time. When No.005 Bit1=1, and the absolute coordinates are set by G50, the relative coordinates are set simultaneously.

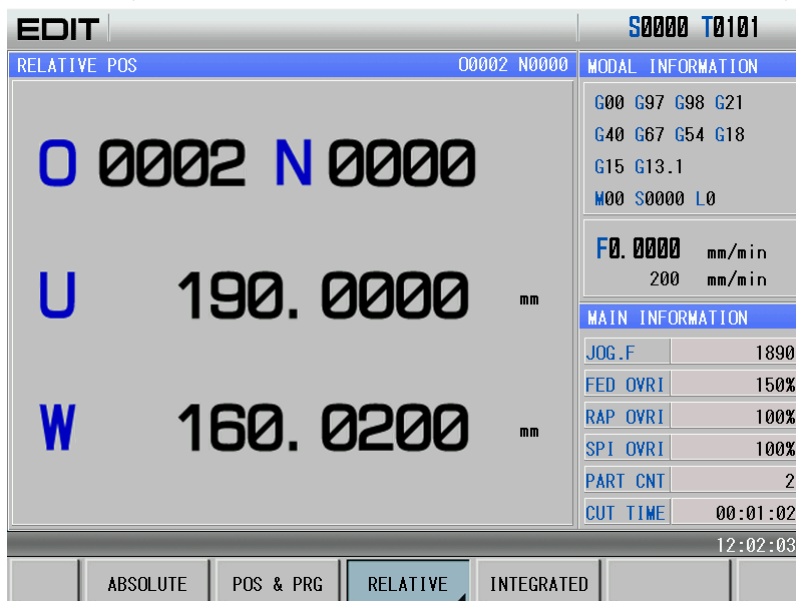

Clearing U, W:

Method 1:

Press **RELATIVE** and the following page appears:



At the moment, press **U CLR** to clear U value, and press **W CLR** to clear W value;

Method 2:

Switch to the relative coordinate page, at the moment, press **U**. Press **CANCEL** to clear U value when the big character "U" flashes in the page. Method of clearing W value is the same those of clearing U value;

**Note: Clearing method is the same when many axes are enabled.**

3) INTEGRATED POS display interface

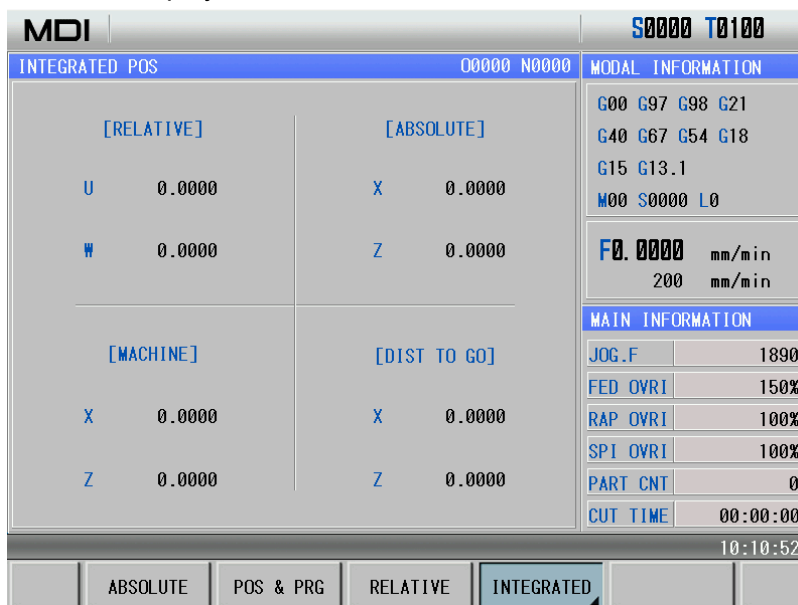

Clearing method of absolute coordinates are shown below:  
Method 1:

Press **INTEGRATED** and the following page is shown:

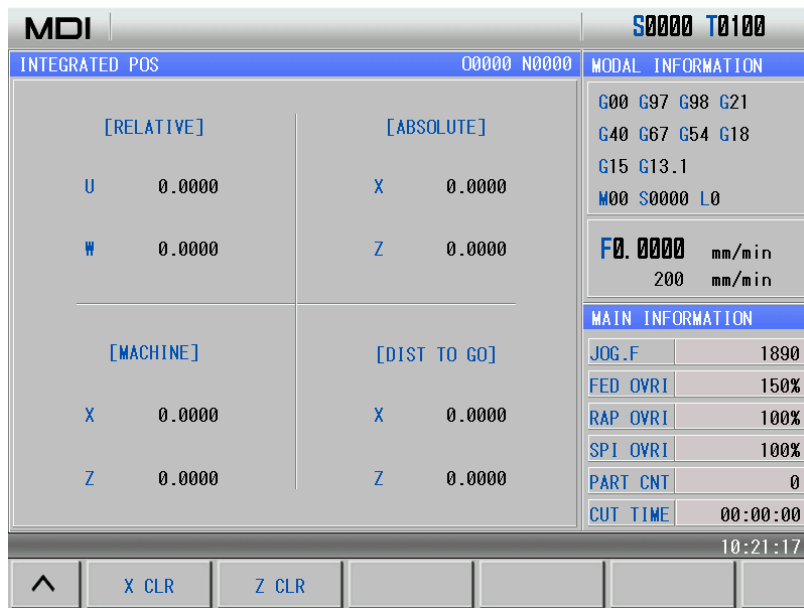

At the moment, press **X CLR** to clear X coordinate value, and press **Z CLR** to clear Z coordinate value;

Method 2:

Switch to the integrated coordinate page, simultaneously press **X** + **CANCEL** to clear X machine coordinate value; meanwhile, press **Z** + **CANCEL** to clear Z machine coordinate value.

**Note 1:** Clearing method is the same when many axes are enabled.

**Note 2:** Clearing operation is enabled only when each axis has no machine zero (No.0014 bit0 ~ bit4 is set to 0).

4) POS&PRG display interface

In POS&PRG interface, it displays ABSOLUTE, RELATIVE coordinate of the current position (ABSOLUTE, DIST TO GO of current position and machine coordinates will be displayed when No.180 BIT0 is set to 1) as well as 7 blocks of current program together. During the program execution, the displayed blocks are refreshed dynamically and the cursor is located in the block being executed.

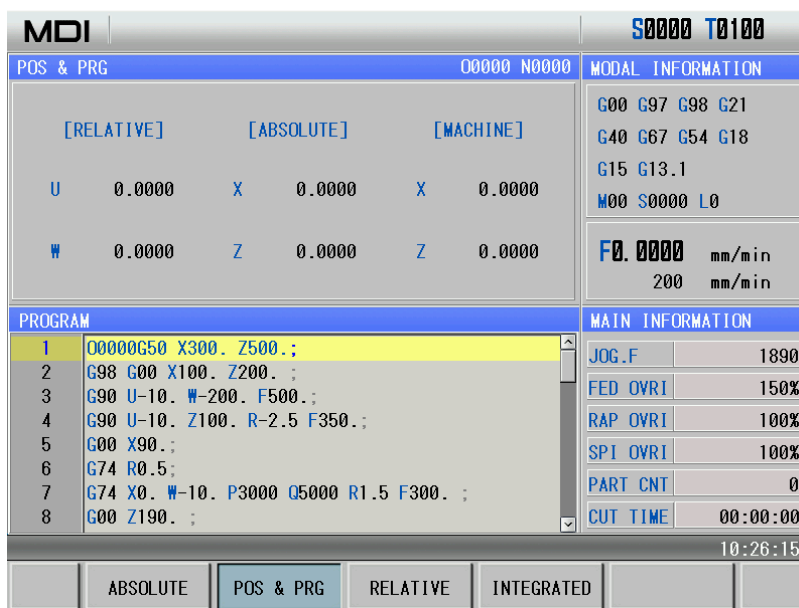

### 1.3.2 PRG interface

Press **PROGRAM** to enter PRG interface, which includes **PROGRAM CONTENT** **MDI PROGRAM** **LOCAL DIR.** (the

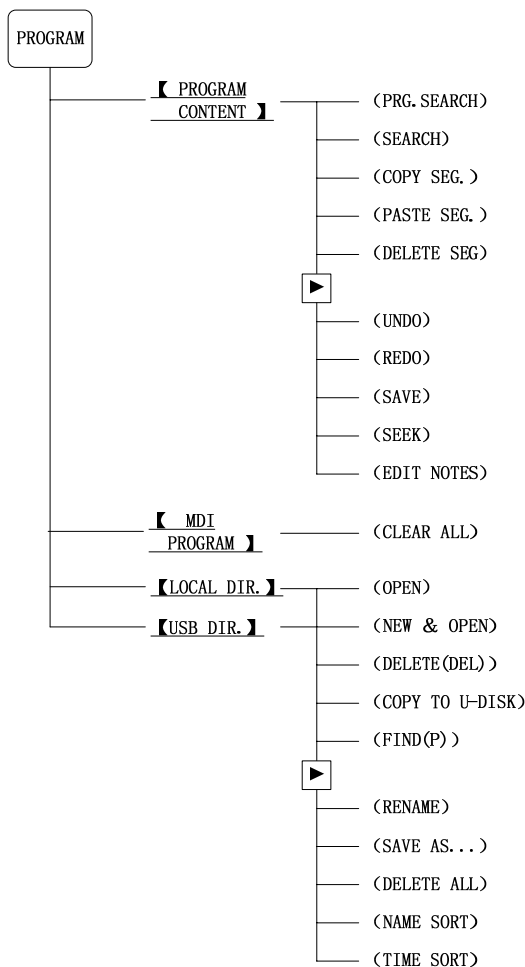

soft function menu can be displayed when USB device is connected to the system). Press **PROGRAM** repetitively or press the corresponding soft function keys to switch interfaces. The interface is shown below:



The following description is valid when GSK980TDc has been connected with USB device.

1) PRG CONTENT page

In the page, the program content including current block can be displayed. In Edit mode, the

program content can be viewed forward or backward by pressing  or  key.

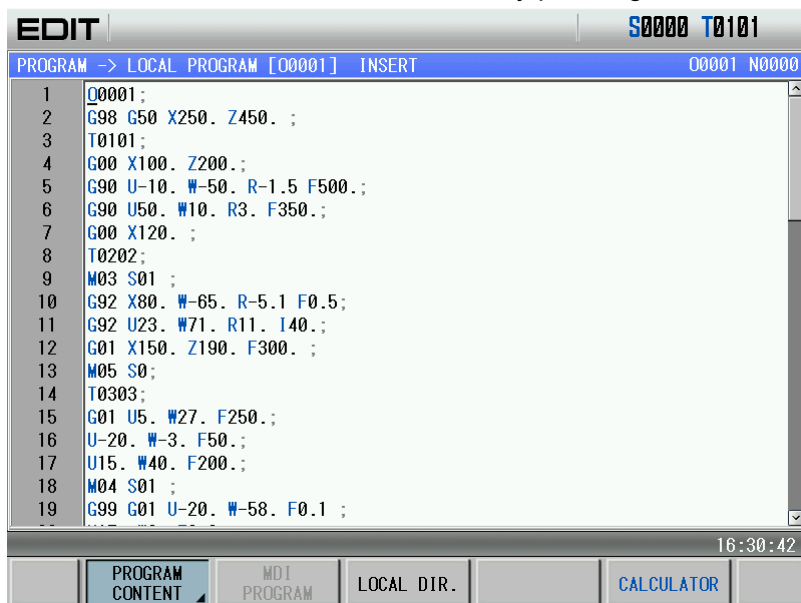

2) MDI program page

In MDI mode, the page can be displayed, and its value when the corresponding soft function key is pressed as follows:

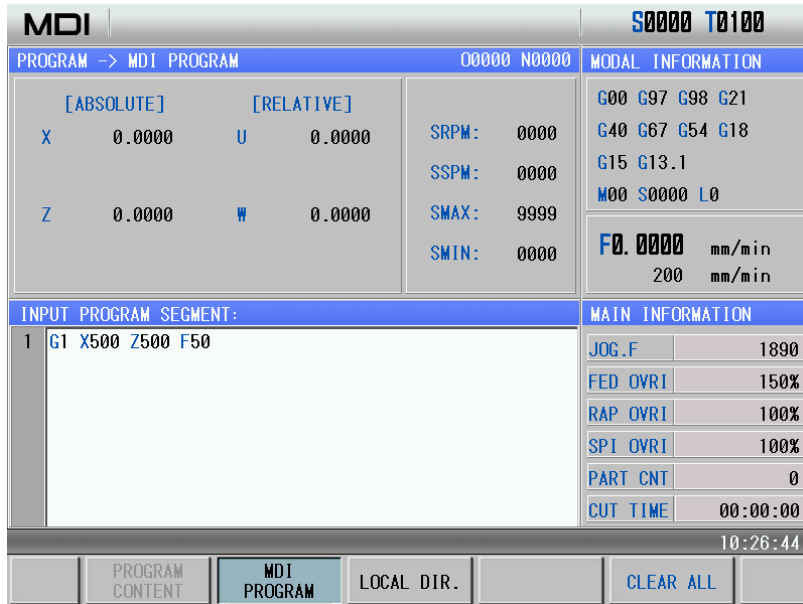

### 3) Local directory page

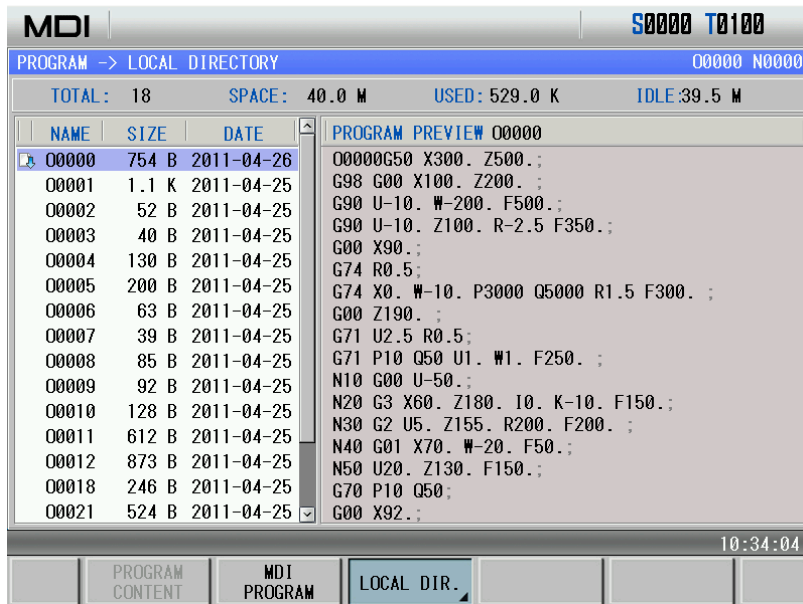

Press **LOCAL DIR.** to enter the local program page as follows:

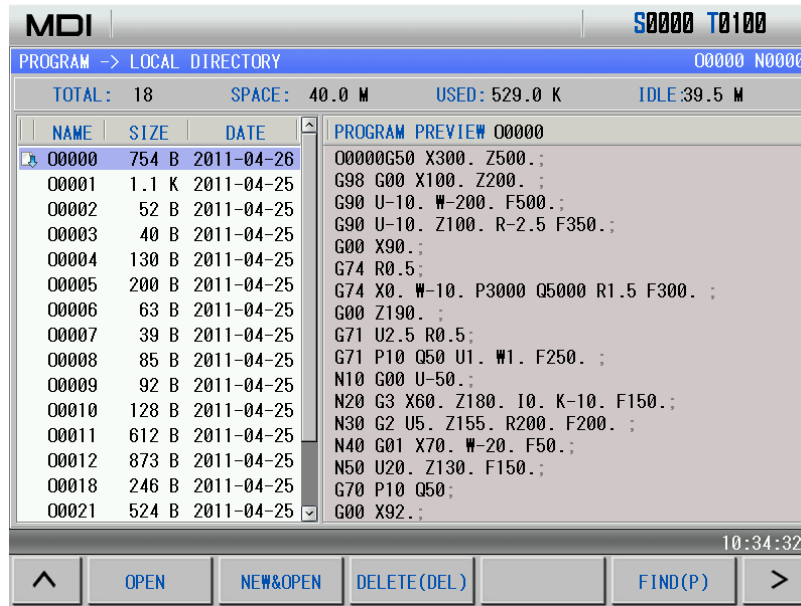

Press  to enter the next menu as follows:

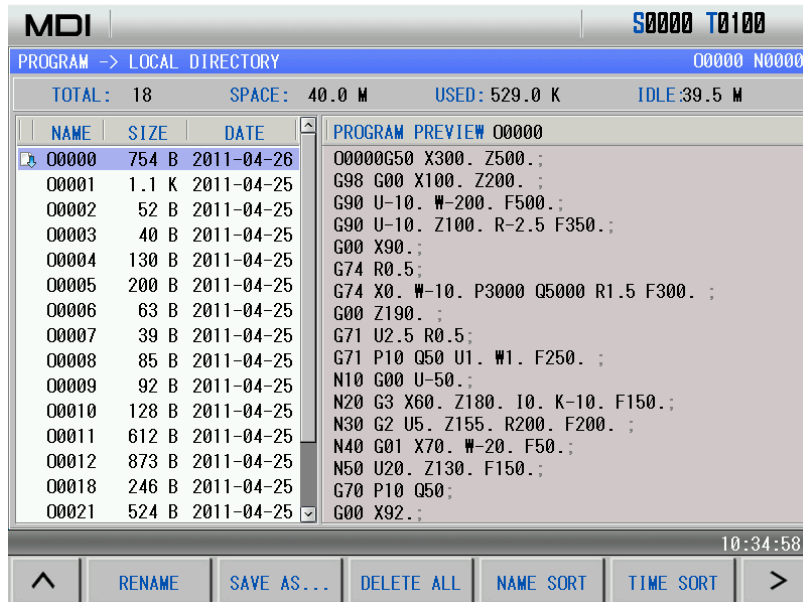

4) U disk directory page

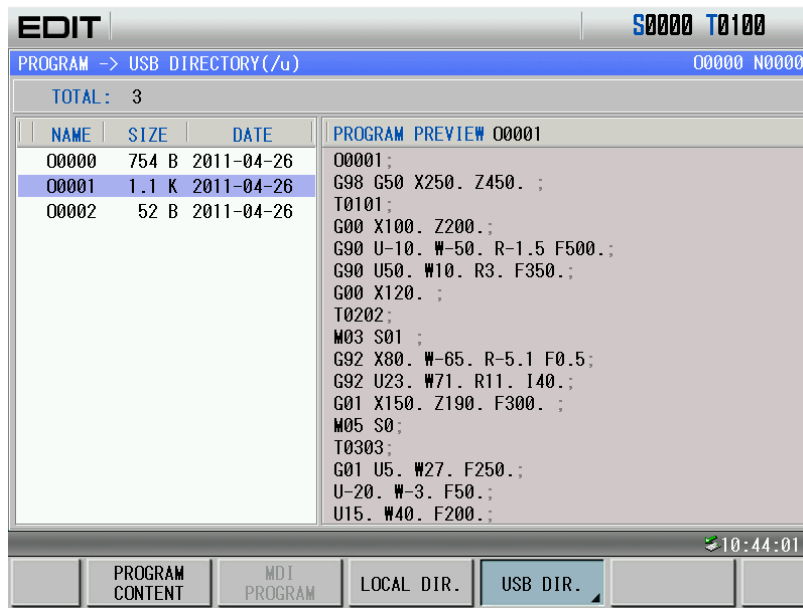

Press  to enter U disk directory page as follows:

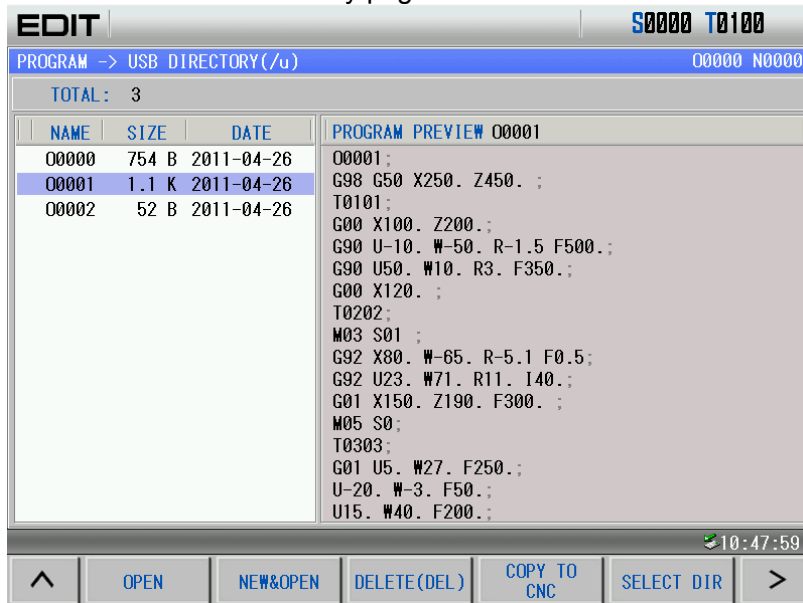

Press  to enter the next menu as follows:



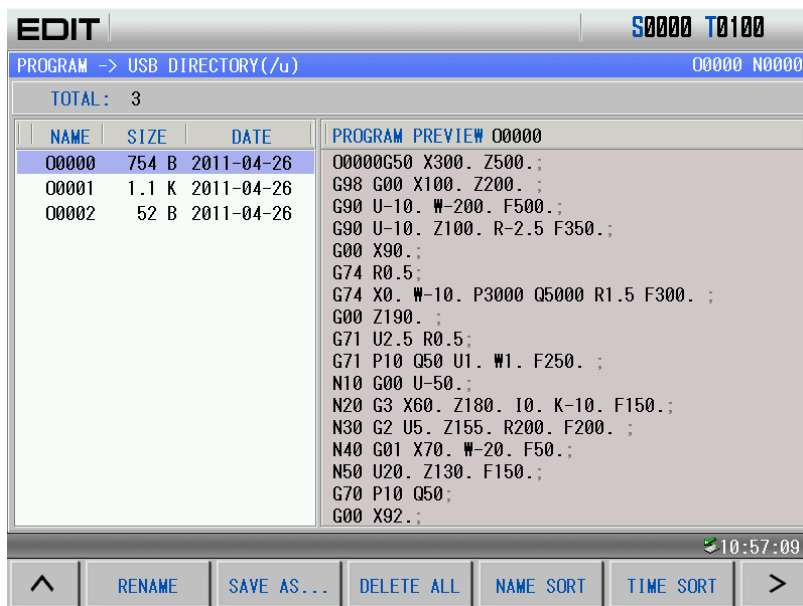

### 1.3.3 TOOL OFFSET Interface

Press **OFFSET** to enter the TOOL OFFSET interface which includes **OFFSET CD.**, **MACRO VAR.**, **OFFSET CD.**, **TOOL-LIFE** (it enters the interface when No. 002 Bit0 is set to 1). Press **OFFSET** repetitively or corresponding keys to switch pages. The interface is shown below:

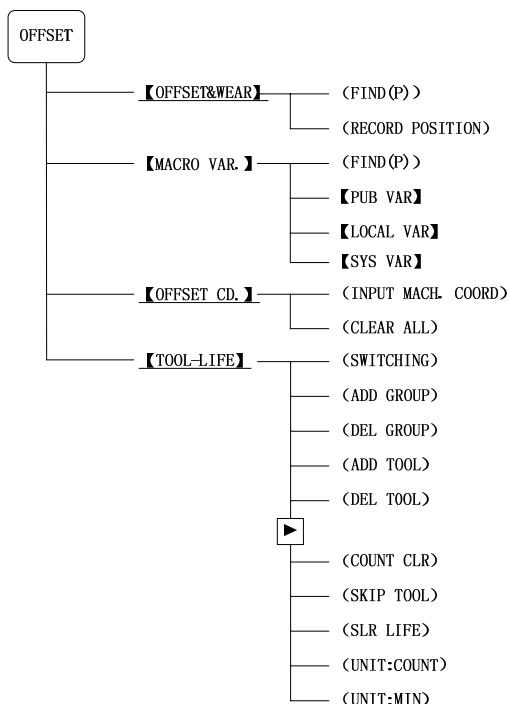



#### 1) TOOL OFFSET&WEAR interface

There are 5 pages and 33 offset & wear No. (No.000~No.032) available for user in the interface, which can be shown as follows by pressing or key.

EDIT						S0000 T0100
TOOL -> OFFSET & WEAR						COORDINATES
NO.		X	Z	R	T	
00	OFT	0.0000	0.0000	0.0000	0	[RELATIVE]
		-----	-----	-----		
01	OFT	0.0000	0.0000	0.0000	0	U 0.0000
	WEAR	0.0000	0.0000	0.0000	0	W 0.0000
02	OFT	0.0000	0.0000	0.0000	0	
	WEAR	0.0000	0.0000	0.0000	0	
03	OFT	0.0000	0.0000	0.0000	0	[ABSOLUTE]
	WEAR	0.0000	0.0000	0.0000	0	X 0.0000
04	OFT	0.0000	0.0000	0.0000	0	Z 0.0000
	WEAR	0.0000	0.0000	0.0000	0	
05	OFT	0.0000	0.0000	0.0000	0	
	WEAR	0.0000	0.0000	0.0000	0	
06	OFT	0.0000	0.0000	0.0000	0	
	WEAR	0.0000	0.0000	0.0000	0	

11:01:26

OFFSET&WEAR    MACRO VAR.    OFFSET CD.    TOOL-LIFE    FIND(P)

When the valid axis number is more than 2, pressing  or  can display the tool offset & wear pages of other three axes, which is shown below.



MDI						S0000 T0101
TOOL -> OFFSET & WEAR						COORDINATES
NO.		A	B	C		
00	OFT	0.0000	0.0000	0.0000		[RELATIVE]
		-----	-----	-----		
01	OFT	0.0000	0.0000	0.0000		U 250.0000
	WEAR	0.0000	0.0000	0.0000		W 450.0000
02	OFT	0.0000	0.0000	0.0000		A 0.0000
	WEAR	0.0000	0.0000	0.0000		B 0.0000
03	OFT	0.0000	0.0000	0.0000		H 0.0000
	WEAR	0.0000	0.0000	0.0000		
04	OFT	0.0000	0.0000	0.0000		[ABSOLUTE]
	WEAR	0.0000	0.0000	0.0000		X 250.0000
05	OFT	0.0000	0.0000	0.0000		Z 450.0000
	WEAR	0.0000	0.0000	0.0000		A 0.0000
06	OFT	0.0000	0.0000	0.0000		B 0.0000
	WEAR	0.0000	0.0000	0.0000		C 0.0000

09:09:09

OFFSET&WEAR    MACRO VAR.    OFFSET CD.    FIND(P)

Note: The axis names of Y, the 4<sup>th</sup>, the 5<sup>th</sup> axis is defined by No.225.

## 2) MACRO interface

There are 25 pages in this interface, which can be shown by pressing  or  key. In Macro window there are 600 (No.100~No.199 and No.500~No.999) macro variables which can be specified by macro command or set directly by keypad. The public variable page is shown below:

EDIT						S0000 T0100
OFT -> MACRO [PUBLIC VARIABLE]						00000 N0000
NO.	DATA	NO.	DATA	NO.	DATA	
100		112		124		
101		113		125		
102		114		126		
103		115		127		
104		116		128		
105		117		129		
106		118		130		
107		119		131		
108		120		132		
109		121		133		
110		122		134		
111		123		135		

0100 STORE VARIABLE. RESET 0 WHEN POWER ON .

11:01:55

The local variable page is shown below:

EDIT						S0000 T0100
OFT -> MACRO [LOCAL VARIABLE]						00000 N0000
NO.	DATA	NO.	DATA	NO.	DATA	
1		13		25		
2		14		26		
3		15		27		
4		16		28		
5		17		29		
6		18		30		
7		19		31		
8		20		32		
9		21		33		
10		22				
11		23				
12		24				

0001 STORE VARIABLE. RESET 0 WHEN POWER ON .

11:02:08

The system variable page is shown below:

EDIT						S0000 T0100
OFT -> MACRO [SYSTEM VARIABLE]						O0000 N0000
NO.	DATA	NO.	DATA	NO.	DATA	
1000	0	1012	0	1107	0	
1001	0	1013	0	1108	0	
1002	0	1014	0	1109	0	
1003	0	1015	0	1110	0	
1004	0	1032	0	1111	0	
1005	0	1100	0	1112	0	
1006	0	1101	0	1113	0	
1007	0	1102	0	1114	0	
1008	0	1103	0	1115	0	
1009	0	1104	0	1132	0	
1010	0	1105	0	1133	0	
1011	0	1106	0	2001	0.0	

1000 GET G54.0 VALUE

11:02:21

^ PUB VAR LOCAL VAR **SYS VAR** FIND(P)

Note: The local variable and the system local are specified by macro codes instead of directly set by the keyboard in the page.

II Operation

### 3) Workpiec coordinate system setting

EDIT						S0000 T0100
OFFSET -> WORKPIECE COORDINATE SYSTEM						O0000 N0000
						COORDINATES
EXT OFFSET		G54 COORD.		G55 COORD.		[ABSOLUTE]
X	0.0000	X	0.0000	X	0.0000	X 0.0000
Z	0.0000	Z	0.0000	Z	0.0000	Z 0.0000
G56 COORD.		G57 COORD.		G58 COORD.		[MACHINE]
X	0.0000	X	0.0000	X	0.0000	X 0.0000
Z	0.0000	Z	0.0000	Z	0.0000	Z 0.0000

11:02:44

OFFSET&WEAR MACRO VAR. **OFFSET CD.** TOOL-LIFE INPUT MACH. COORD

### 4) Tool life management

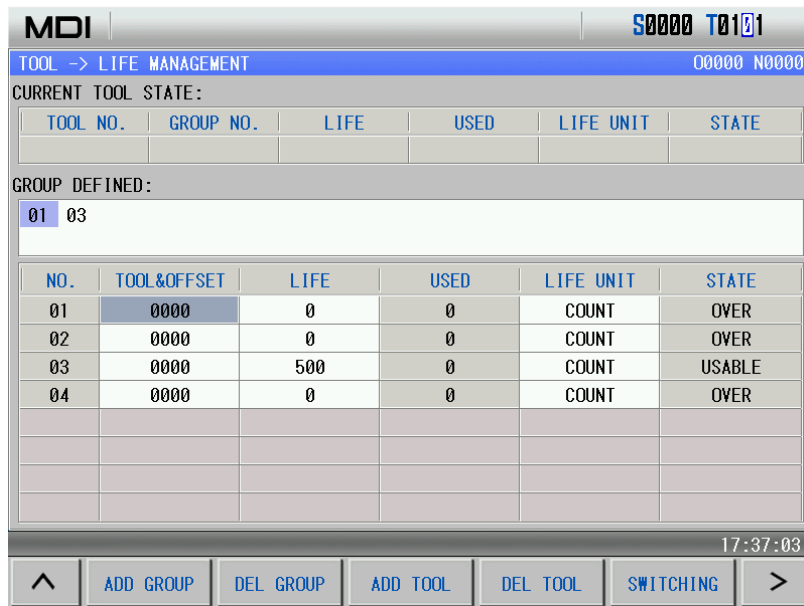

### 1.3.4 ALARM interface

1) Alarm:

Press **ALARM** key to enter alarm interface including **ALM INFOR.**, **ALM LOG** which can be switched by pressing repetitively **ALARM**, or the corresponding soft function. The alarm interface is shown below:

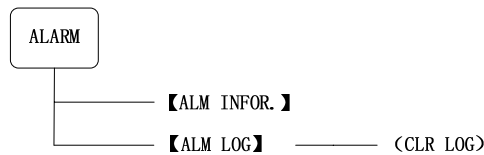

1) Alarm information page

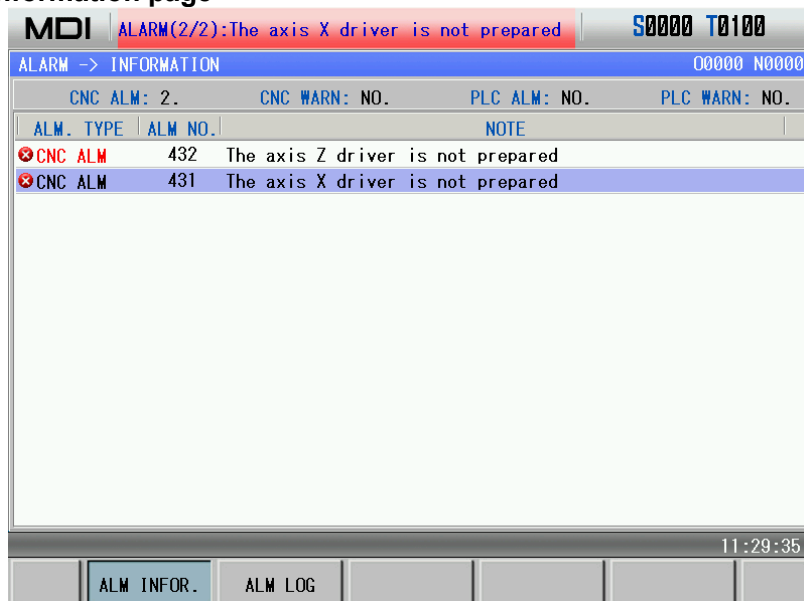

Note: Alarm clearing: It can clear alarms by pressing **RESET**.

2) Alarm log page

MDI		ALARM(2/2):The axis X driver is not prepared		S0000 T0100	
ALARM -> LOG				00000 N0000	
ALM. TYPE	ALM NO.	NOTE	ALARM TIME		
CNC ALM	431	The axis X driver is not prepared	2011-04-26,11:31:25		
CNC ALM	432	The axis Z driver is not prepared	2011-04-26,11:31:23		
CNC ALM	3	FILE:00000 LINE:1 Total characters of one command is out of range(2~11char)	2011-04-26,11:31:08		
CNC ALM	431	The axis X driver is not prepared	2011-04-26,11:29:04		
CNC ALM	432	The axis Z driver is not prepared	2011-04-26,11:29:02		
CNC ALM	301	Parameter switch has been opened	2011-04-26,09:19:39		
CNC ALM	354	turn on power again when parameter is modified	2011-04-26,09:18:29		
CNC ALM	301	Parameter switch has been opened	2011-04-26,09:18:04		
CNC ALM	354	turn on power again when parameter is modified	2011-04-25,17:52:41		
CNC ALM	301	Parameter switch has been opened	2011-04-25,17:52:05		
CNC ALM	354	turn on power again when parameter is modified	2011-04-25,17:51:22		

11:39:11

ALM INFOR.    ALM LOG    CLR LOG

II Operation

1.3.5 Setting interface

Press **SETTING** to enter the SETTING interface including **CNC SETTING** **CLOCK** **DOC LIST**

which can be switched by pressing repeatedly **SETTING** or corresponding soft keys. The interface is shown below:

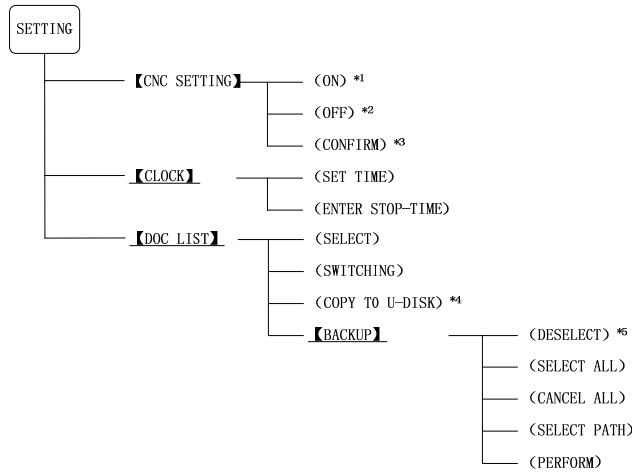

**Note 1:** \*1, \*2 soft function menus are displayed but \*3 is not done when the cursor is in the switch setting

column in **CNC SETTING** page; \*1, \*2 soft function menus are not displayed but \*3 is done when the cursor is in the privilege setting or parameter setting column;

**Note 2:** \*4 soft function menu is displayed to (Copy to U disk) when the cursor is in CNC directory in **DOC LIST** page; it is displayed to (Copy to CNC) when the cursor is in U disk directory;

**Note 3:** \*5 soft function menu is displayed to (Select) when the system enters into **BACKUP** page and the item where the cursor is has not selected; it is displayed when the item has selected.

1) CNC setting page

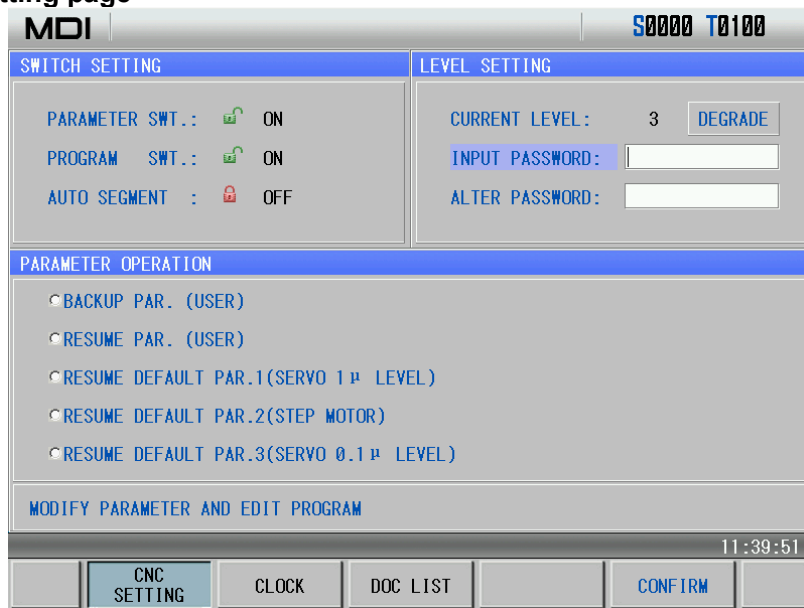

2) System clock page

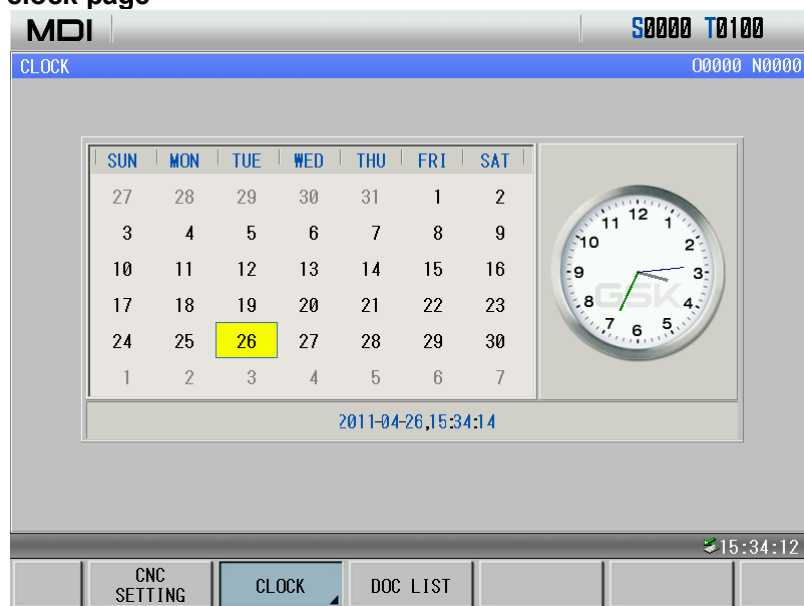

3) Document management page

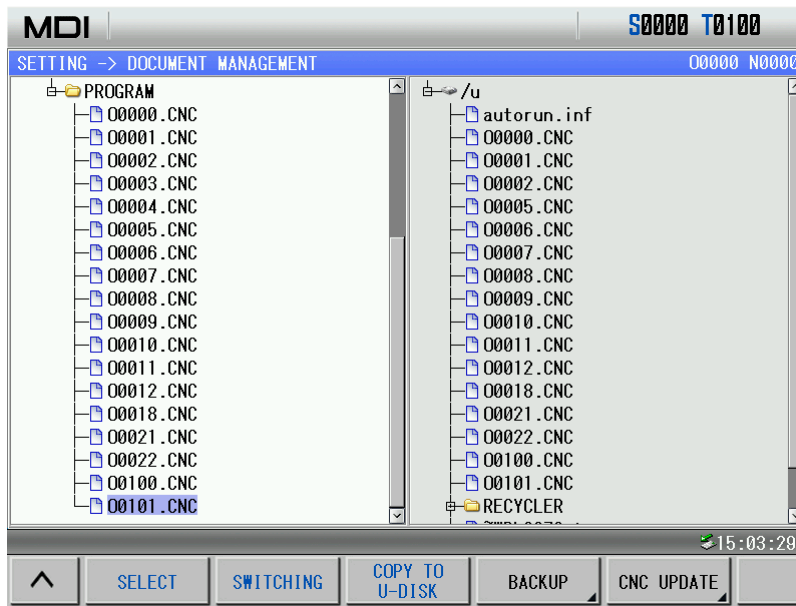

### 1.3.6 PARAMETER Interfaces

Press **PARAMETER** to enters PARAMETER interface including pages **BIT PARA.**, **DATA PARA.**, **OFTEN USED**, **PITCH COMP** which can be switched by pressing repetitively **PARAMETER** or the corresponding soft keys. The interface is shown below:

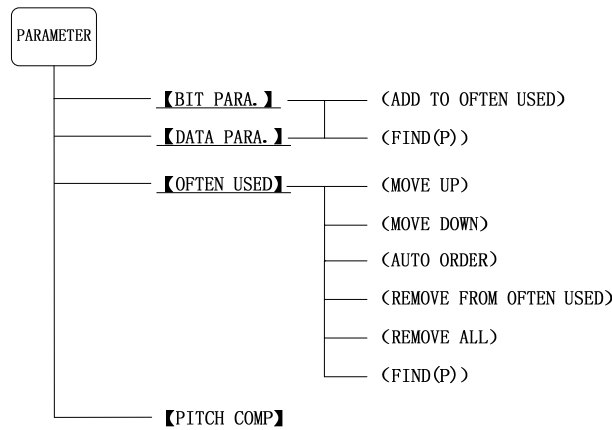

#### 1) Bit parameter page



MDI		S0000 T0100			
PARAMETER -> BIT PARAMETER				00000 N0000	
NO.	DATA	NO.	DATA	NO.	DATA
0001	00011010	0013	00000000	0185	00000000
0002	10000011	0014	00000000	0186	00000000
0003	00010000	0017	00001000	0187 X	00000010
0004	01000000	0018	00000000	---- Z	00000010
0005	00010011	0020	00000000	0188 X	01000101
0006	00000000	0172	01101000	---- Z	01000101
0007	10000000	0174	00001000	0196	00000000
0008	00011111	0175	00000000	0202	00000000
0009	00000000	0180	00000000	0203	00001111
0010	00011111	0181	11100000		
0011	00000000	0183	00000000		
0012	10101011	0184	00000001		

0001 \*\*\* \*\* ACS HWL XRC ISC INI  
BIT7 Reserved

14:15:33

BIT PARA. DATA PARA. OFTEN USED PITCH COMP FIND(P)

2) Data parameter page

MDI		S0000 T0100			
PARAMETER -> DATA PARAMETER				00000 N0000	
NO.	DATA	NO.	DATA	NO.	DATA
0015 X	1	0025	0	0034 Z	0
---- Z	1	0026	100	0035	0
0016 X	1	0027	8000	0036 S1	0
---- Z	1	0028	200	---- S2	0
0019	5	0029	100	0037 S1	9999
0021 S1	0	0030	200	---- S2	9999
---- S2	0	0031	1260	0038 S1	9999
0022 X	4000	0032 X	200	---- S2	9999
---- Z	8000	---- Z	400	0039 S1	9999
0023 X	100	0033 X	100	---- S2	9999
---- Z	100	---- Z	200	0040 S1	9999
0024	0	0034 X	0	---- S2	9999

0015 Command multiplier for each axis

14:15:47

BIT PARA. DATA PARA. OFTEN USED PITCH COMP FIND(P)

3) Common used parameter page

MDI						S0000 T0100
PARAMETER -> OFTEN USED PARAMETER						00000 N0000
NO.	DATA	NO.	DATA	NO.	DATA	
0001	00011010	0016 X	1	0030	200	
0004	01000000	---- Z	1	0031	1260	
0006	00000000	0021 S1	0	0032 X	200	
0007	10000000	---- S2	0	---- Z	400	
0008	00011111	0022 X	4000	0033 X	100	
0009	00000000	---- Z	8000	---- Z	200	
0010	00011111	0023 X	100	0034 X	0	
0011	00000000	---- Z	100	---- Z	0	
0013	00000000	0026	100	0036 S1	0	
0014	00000000	0027	8000	---- S2	0	
0015 X	1	0028	200	0037 S1	9999	
---- Z	1	0029	100	---- S2	9999	

0001 \*\*\* \*\* ACS HML XRC ISC INI  
BIT7 Reserved

11:42:00

BIT PARA. DATA PARA. OFTEN USED PITCH COMP FIND(P)

#### 4) Pitch compensation parameter page

MDI						S0000 T0100
PARAMETER -> SCREW-PITCH COMPENSATION						00000 N0000
AXIS X			AXIS Z			COORDINATES
NO.	VALUE	NO.	VALUE			
0000	0	0200	0	[ABSOLUTE]		
0001	0	0201	0	X	90.0615	
0002	0	0202	0	Z	200.0000	
0003	0	0203	0	[MACHINE]		
0004	0	0204	0	X	90.0615	
0005	0	0205	0	Z	200.0000	
0006	0	0206	0			
0007	0	0207	0			
0008	0	0208	0			
0009	0	0209	0			
0010	0	0210	0			
0011	0	0211	0			
0012	0	0212	0			
0013	0	0213	0			

11:42:29

BIT PARA. DATA PARA. OFTEN USED PITCH COMP FIND(P)

### 1.3.7 Diagnosis Interface

Press **DIAGNOSIS** to enter diagnosis interface including pages **DIAGNOSIS** **CNC VERSION** which can be switched by pressing repetitively **DIAGNOSIS** or the corresponding soft keys. The interface is shown below:

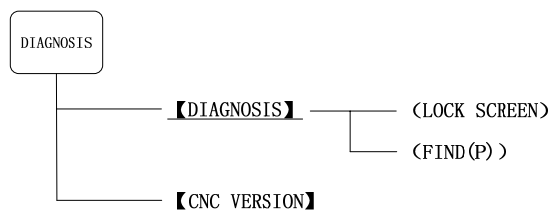

#### 1) System diagnosis page

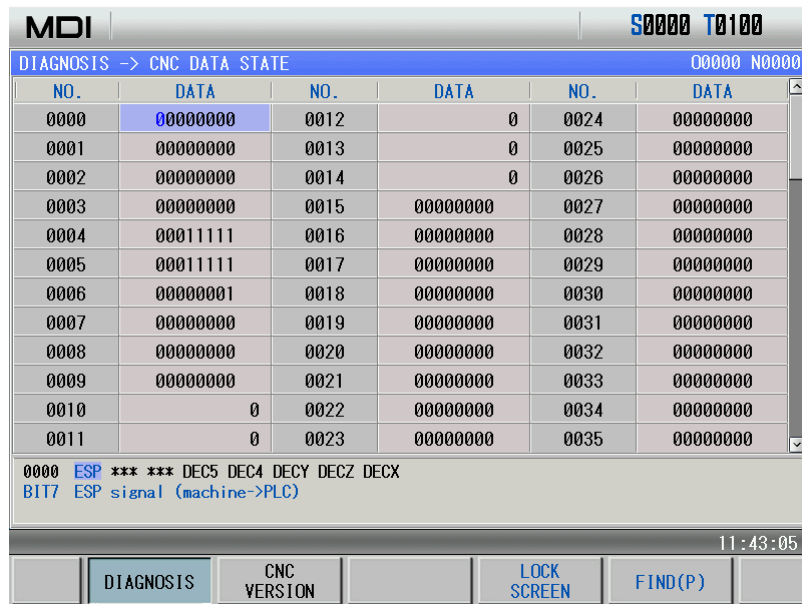

The page is used to detect CNC interface signal and its inner run state. Please refer to INSTALLATION, Section 5.1.

2) System information page

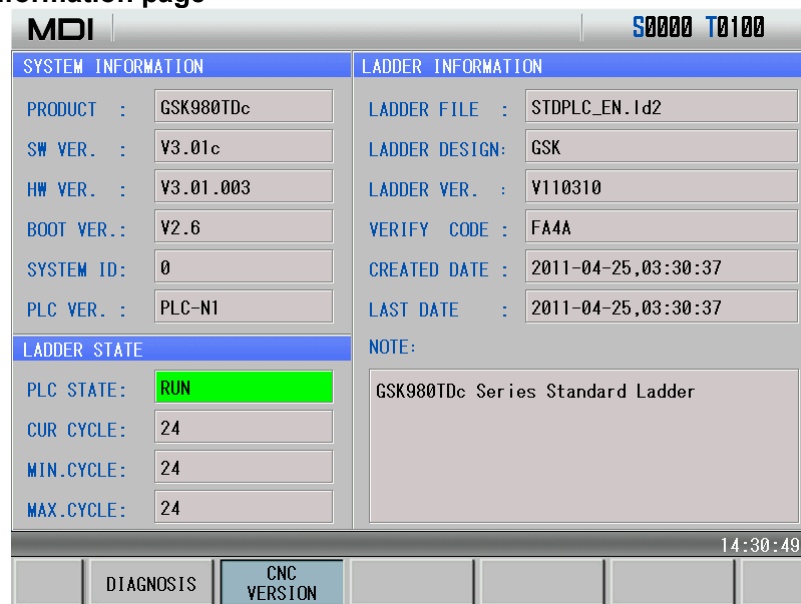

1.3.8 Graph Interface

Press  to enter GRAPH interface. The interface is shown below:

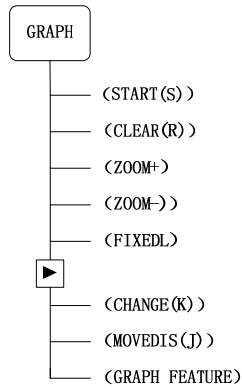

Graph page is shown below:

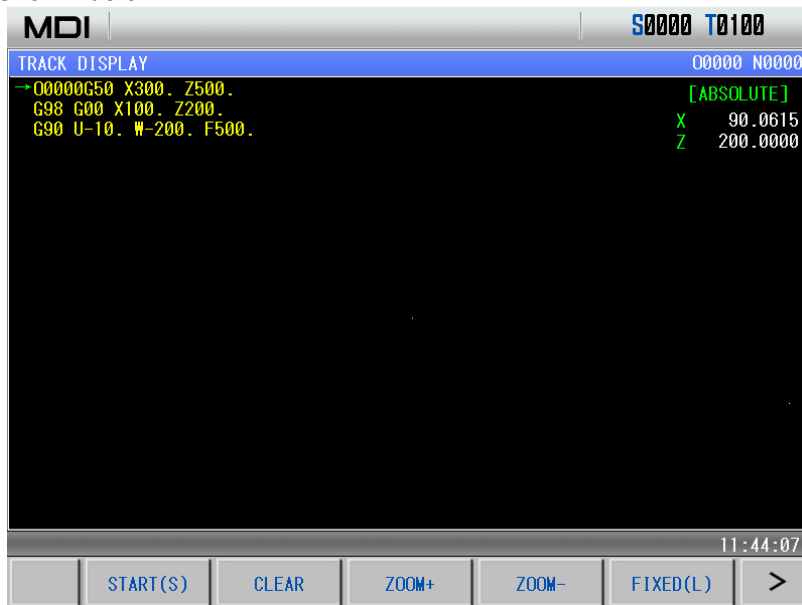

II Operation

### 1.3.9 Ladder Interface

Press **PLC** to enter LADDER interface including pages **I/O STATE**, **MONITOR**, **PLC DATA**, **FILE LIST** which can be switched by pressing repetitively **PLC** or corresponding soft keys. The interface is shown below:

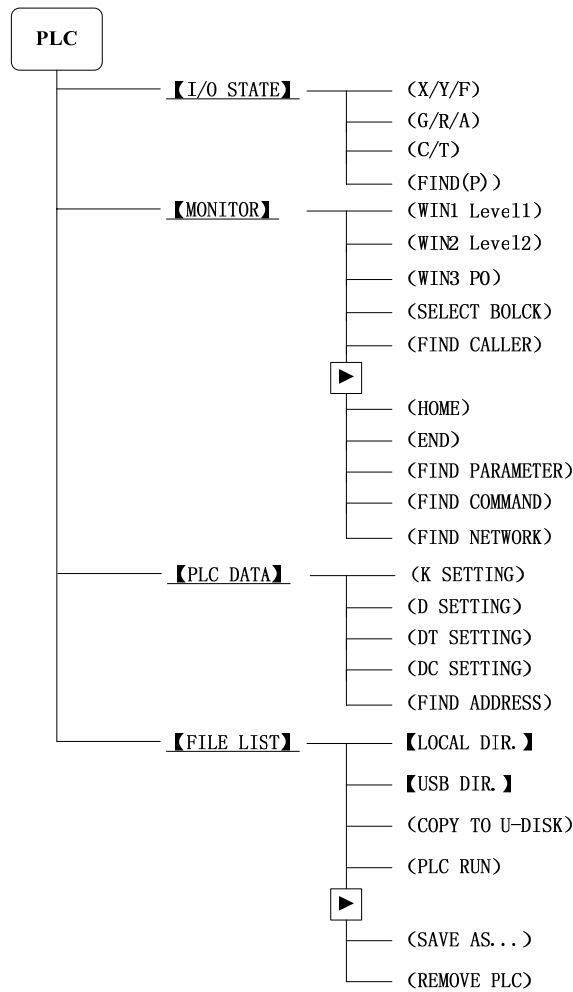

1) PLC I/O state page



The page can display PLC I/o state information.

2) Ladder monitor page

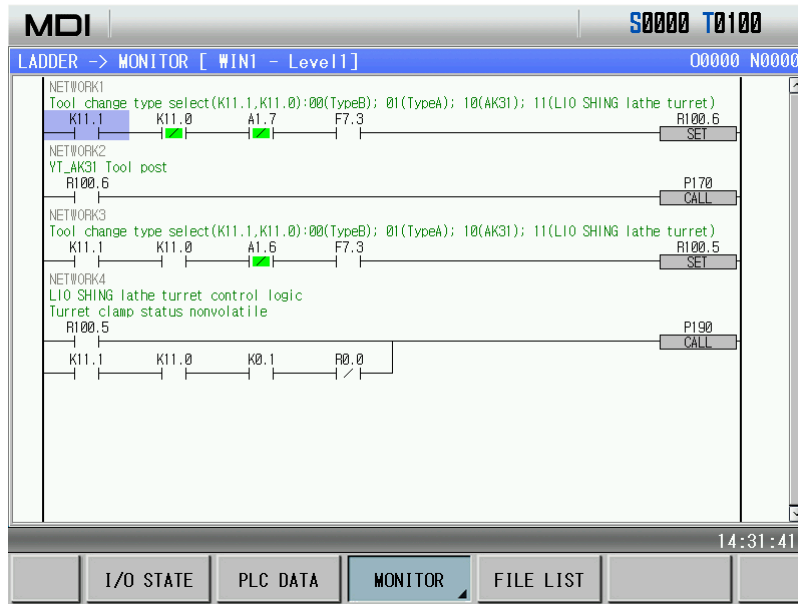

The monitor page can view states of current contact, coil ON/OFF state, values of timer and counter. They are displayed with a green background when they are ON, otherwise, they are the same those of the page background.  $\overline{X0.5}$  means the contact X0.5 is ON,  $Y25.2$  means Y25.2 is OFF.

1. page program view

In MONITOR page, the system can monitor simultaneously three windows, the ladder blocks corresponded to each window can be viewed by separately pressing WIN1  
Level1, WIN2  
Level2, WIN3  
PO, at the moment, the ladder corresponded to the selected block is displayed on the screen.

2. Window block selection

(1) Select the window which needs to select blocks, press respectively WIN1  
Level1, WIN2  
Level2,

WIN3  
PO to select the windows.

(2) Press SELECT  
BLOCK to select the window program. At the moment, the display page is shown

below:

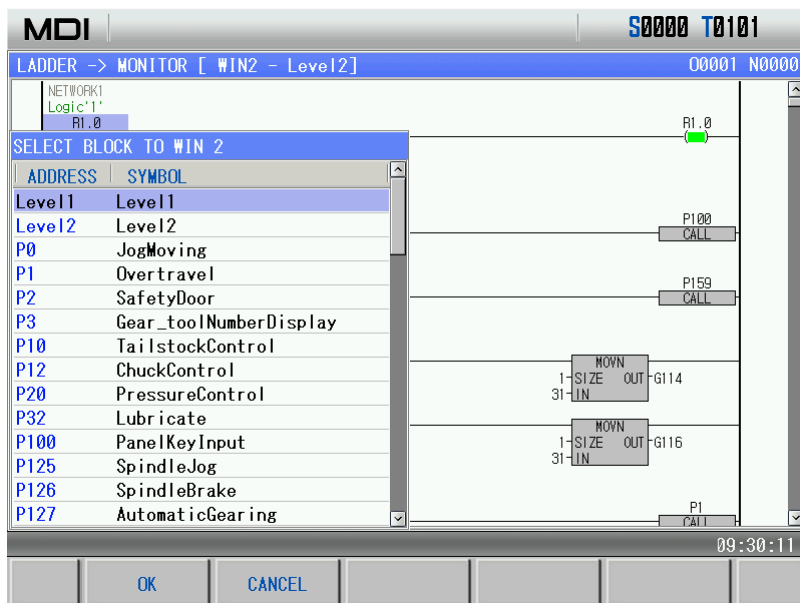

- (3) Move the cursor to select the ladder block for display.
- (4) Press **OK**, and then return the previous menu, press **CANCEL** to cancel the selection operation to return to the previous menu.

3. Find parameters, commands and network

- (1) Select the required block window for finding commands, parameters and network, make the corresponding block display in the window, and find the command, parameters and network in the window.
- (2) Respectively press **FIND PARAMETER**, **FIND COMMAND**, **FIND NETWORK** to find the corresponding parameter, functional command and network in the current displayed block, and move the cursor to the corresponding position.
- (3) Press **HOME**, **END** to locate the cursor to the home or end of the current block.

3) PLC data page

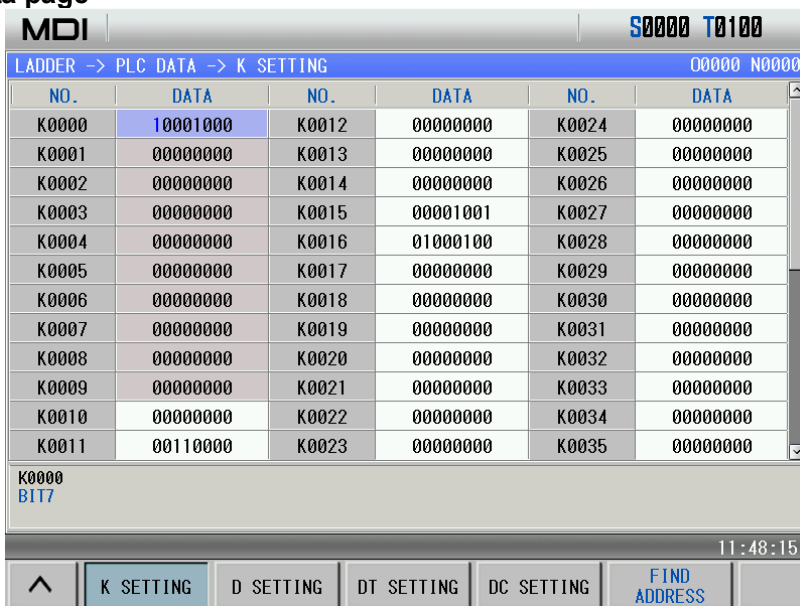

PLC data includes K, D, DT, DC, which can be set in the page.

4) File list page

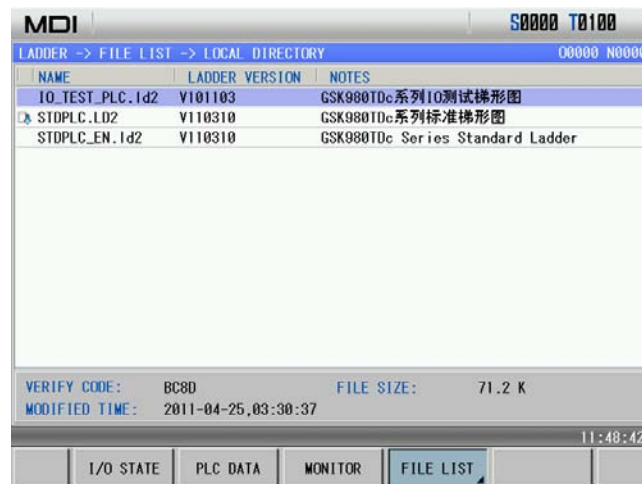

The ladder file list page displays all ladders and their relevant information included in the current system, and the new ladder can run in the page. The program name marked with is the current running ladder.

**Note:** The file list page is displayed when the above 2-level privilege is executed.



## CHAPTER 2 POWER ON/OFF AND PROTECTION

### 2.1 System Power-on

Before GSK980TDc power on, the following items should be confirmed:

1. The machine is in a normal state.
2. The power voltage conforms to the requirement of the machine.
3. The connection is correct and secure.

The following window is displayed after GSK980TDc is turned on:



The current position (ABSOLUTE POS) page is displayed after GSK980TDc automatic detection and initiation are finished.

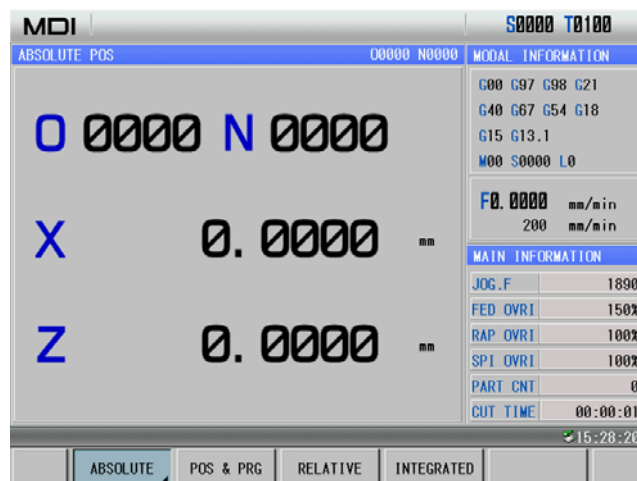

### 2.2 System Power-off

Before power is off, ensure that:

1. The feed axes of the CNC is at stop;
2. Miscellaneous functions (spindle, cooling etc.) are OFF;
3. Cut off CNC power prior to machine power cutting off.

**Note:** Please refer to the machine manufacturer's manual about turn-off the machine's power supply.

## 2.3 Overtravel Protection

Overtravel protection should be used to prevent machine from being damaged due to the overtravel of X, Y, or Z.

### 2.3.1 Hardware overtravel protection

The stroke switches are fixed at the positive and negative maximum travel of the machine X, Z, Y axis respectively, they are connected by the following figure. And the BIT3 of bit parameter No.172 must be set to 0. If the overtravel occurs, the stroke switch acts to make GSK980TDc stop, and the emergency alarm is issued.

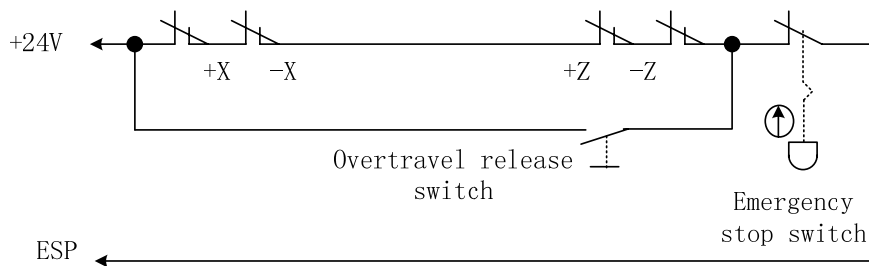

When the hardware overtravel occurs, there will be an “emergency stop” alarm in GSK980TDc. The steps to eliminate this alarm are: press the OVERTRAVEL button to switch to the ALARM page, view the alarm message, and reset the alarm and move the table reversely to detach the stroke switch (for positive overtravel, move negatively; vice versa) .

### 2.3.2 Software Overtravel Protection

When the Bit4 of bit parameter No.172 is set to 0, the software limit is active.

#### 1. X, Z axis

The software strokes are set by data parameter No.045, No.046, they refer to the machine coordinates. As follows figure shows, X, Z are the machine coordinate system axes; No.045 is for X axis positive and negative strokes, No.046 is for Z axis positive and negative strokes, within the broken line is the software stroke scope.

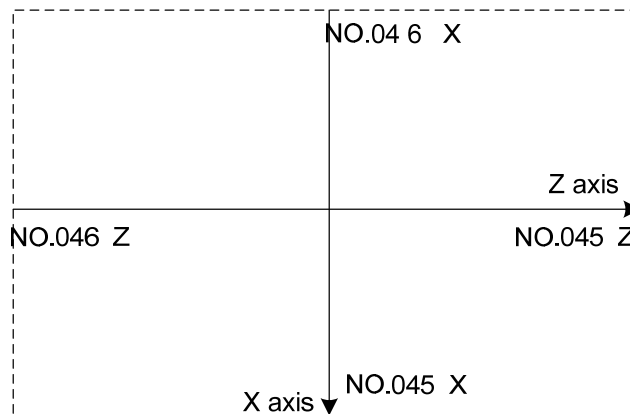

If the machine position (coordinate) exceeds the area within broken line, overtravel alarm will be issued. The steps to eliminate this alarm are: press the overtravel alarm release key to clear the

alarm, then moves reversely (for positive overtravel, move out negatively; vice versa).

## 2. Additional axis

The stroke range setting is the same that of the basic axis. When the additional axis is enabled, No. 045, No.046 displays stroke range parameter of the corresponding additional axis.

## 2.4 Emergency Operation

During the machining, some unexpected incidents may occur because of the user programming, operation and product fault etc. So the GSK980TDc should be stopped immediately for these incidents. This section mainly describes the resolutions that the system is capable of under the emergency situation. Please see the relative explanation on these resolutions under the emergency by machine manufacturer.

### 2.4.1 Reset

Press  key to reset GSK980TDc system when there are abnormal output and axis operations:

- 1 All axes motion stops;
- 2 M, S function output is inactive (the parameter sets whether the system automatically cuts off

signals of spindle rotation, lubricating, cooling by pressing  key, defined by PLC ladder);

- 3 Automatic run ends, modal function and state remain.

### 2.4.2 Emergency stop

During machine running, if the emergency button is pressed under the dangerous or emergent situation (external SP signal active), the CNC system enters into emergency status and the machine movement is stopped immediately. All the outputs such as the spindle running, cooling are cut off. If the emergency button is released, the emergency alarm is cancelled and the CNC resets. Its circuit wiring is shown in **Section 2.3.1** of the Chapter.

**Note 1:** Ensure the fault is eliminated before the emergency alarm is cancelled.

**Note 2:** Pressing down the Emergency button prior to power on or off may alleviate the electric shock to the machine system.

**Note 3:** Re-perform the machine zero return to get the correct position coordinate after the emergency alarm is cancelled (machine zero return is forbidden if there is no machine zero on the machine.).

**Note 4:** Only Bit3 of the bit parameter No.172 is set to 0, is the external emergency stop active.

### 2.4.3 Feed hold

Press  key during the machine running to make the running pause. However, in threading cutting, tapping cycle state, the function cannot stop the running immediately.

### 2.4.4 Power-off

Under the dangerous or emergency situations during the machine running, the machine power

should be cut off immediately to avoid the accidents. But it should be noted that there may be a large error between the CNC coordinates displayed and the actual position. So the toolsetting operation should be performed again.

# CHAPTER 3 MANUAL OPERATION

**Note!**

The key functions of this GSK980TDc machine panel are defined by PLC program (ladders), please refer to the manual from the machine builder for their function significance.

Please note that the following functions for the machine panel keys are described based on the GSK980TDc standard PLC programs!



Press key, it enters Manual mode. In the mode, the system can perform the manual feed, spindle control, override adjustment, tool change etc..

## 3.1 Coordinate Axis Move

In Manual mode, 2 coordinate axes can perform manual feeding and rapid traverse.















### 3.1.1 Manual feed

Press or in and X feeds negatively or positively, and its feeding stops if the key is released; press or and Z axis feeds negatively or positively, and its feeding stops if the key is released; press or , and Y feeds negatively or positively, and its feeding stops if the key is released; press or and the 4<sup>th</sup> axis feeds negatively or positively, and its feeding stops if the key is released; press or and the 5th axis feeds negatively or positively, and its feeding stops if the key is released.

In Manual mode, press key to make the indicator enter the manual rapid traverse mode.

### 3.1.2 Manual rapid traverse

II Operation



Press  in     and the key indicator is ON; press  or  and X feeds negatively or positively, and its feeding stops if the key is released; press  or  and Z axis feeds negatively or positively, and its feeding stops if the key is released; press  or  , and Y feeds negatively or positively, and its feeding stops if the key is released; press  or  and the 4<sup>th</sup> axis feeds negatively or positively, and its feeding stops if the key is released; press  or  and the 5th axis feeds negatively or positively, and its feeding stops if the key is released. The rapid override time-tuning is enabled.

In Manual mode, press  key to make the indicator OFF, and the rapid traverse is disabled and manual feed is executed.

**Note 1:** If no reference point return is performed after power on, as the rapid traverse switch is turned on (rapid indicator ON), the manual feedrate or rapid rate for the traverse is defined by the Bit0 of the bit parameter No.012 of this GSK980TDc system.

**Note 2:** In Edit/MPG mode,  key is inactive.

### 3.1.3 Speed tune

In Manual mode, press    to alter the manual feed override which is divided into 16 steps. The relation of the override and the feedrate is as follows table when data parameter No.031 is set to 1260:

Feedrate override (%)	Feedrate (mm/min)
0	0
10	126
20	252
30	378
40	504
50	630
60	756
70	882
80	1008
90	1134
100	1260
110	1386
120	1512
130	1638

Feedrate override (%)	Feedrate (mm/min)
140	1764
150	1890

**Note :** There is about 2% error for the data in the above table.



In the manual rapid traverse, it can press key to alter the rapid override, and there are 4 steps of F0, 25%, 50%, 100% for the override. (F0 is set by data parameter No.032)

The rapid override is active under the following conditions:

- (1) G00 rapid traverse
- (2) Rapid traverse in canned cycle
- (3) Rapid traverse in G28
- (4) Manual rapid traverse

### 3.2 Other Manual Operations

#### 3.2.1 Spindle CCW, CW, stop control



: In Manual mode, the spindle rotates counterclockwise if pressing this key;



: In Manual mode, the spindle stops if pressing this key;



: In Manual mode, the spindle rotates clockwise if pressing this key.

#### 3.2.2 Spindle jog



: At the moment, the spindle is in JOG state.

Functional description:



Press to enter JOG mode, and the spindle JOG function ON/OFF is executed only when the spindle is in the state of stop.

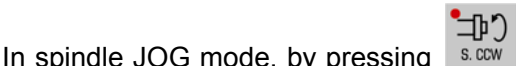

In spindle JOG mode, by pressing key, the spindle rotates counterclockwise for jogging;



by pressing key, the spindle rotates clockwise for jogging. The jog time and speed are set by data parameter No.108 and No.109 respectively.

When the spindle JOG rotates, is pressed to stop the spindle JOG rotation, the spindle brake signal is not output when the JOG rotation stops.

K10.4 is set to 1, the spindle JOG is valid in any mode. In Auto or MDI mode, the spindle is in the JOG rotation state, the program closes the spindle JOG rotation and the JOG function.

**Parameter setting:**

PLC parameter K104 1/0: the spindle JOG is valid in any mode/Manual, MPG, Zero return mode.

Data parameter No.108: spindle JOG time

Data parameter No.109: rotary speed in spindle JOG.

### 3.2.3 Cooling control



: In Manual mode, press this key, the cooling is switched on/off.

Parameter setting: PLC parameter K10.1 1/0: the spindle lubricating and cooling output remains/closes in reset.

### 3.2.4 Lubricating control

#### Function description:

#### 1. Non-automatic lubricating (DT017 =0)

When PLC DT013=0, it is the lubricating turn output. Pressing the  can execute the output. And the lubricating is cancelled by pressing it again. M32 is to execute lubricating output, and M33 is to cancel lubricating output.

When PLC DT013 >1, it is timing lubricating output. Pressing the  can execute the output. And it is cancelled after a setting time by data parameter DT013; M32 is to execute lubricating output and the output is cancelled after a time set by DT013. If the setting time is not yet up, M33 is executed to cancel the lubricating output.

#### 2. Automatic lubricating (DT017>0)

For automatic lubricating, the system executes the lubricating in the time set by DT017 and the stops the output. After lubricating interval time set by DT016, the output is done again, it does repetitively like this. During the automatic lubricating, M32, M33 codes as well as the  key are all active.

#### Parameter setting:

PLC parameter: K10.1 1/0: the spindle lubricating/cooling output remains/closes in reset;

PLC parameter:K16.2 1/0: whether the lubricating outputs in power-on when the automatic lubricating is valid;

PLC data DT005: M execution duration(ms);

PLC data DT013: lubricating start time (0-60000ms)(0:lubricating time is not limited);

PLC data: DT016 automatic lubricating interval time (ms);

PLC data: DT017: automatic lubricating output time (ms).

### 3.2.5 Chuck control



: press it to switch the chuck releasing/clamping in any mode.

#### Function description:

When the chuck control is invalid, the system alarms in executing the chuck control M command;

When the system checks the chuck clamping (K12.1=1), the spindle cannot be started when the chuck is not clamped, and the chuck cannot be released after the spindle is started;

When using the input signal controls the chuck operation, the spindle should stop and delay the time set by DT21, the control is valid.



**Parameter setting:**

PLC parameter: K12.0 1/0: chuck control valid/invalid;

PLC parameter: K12.1 1/0: do not check/check the chuck clamping before the spindle start;

PLC parameter: K12.2 1/0: chuck outer/inner control mode;

PLC parameter: K12.3 1/0: check/not chuck in-position signal;

PLC data: DT018: chuck pulse output width(ms);

PLC data: DT021: spindle stops, chuck operation enabling delays(ms).

**Note: The chuck function is only for GSK980TDc-V CNC system.**

### 3.2.6 Tailstock control



: In any mode, press it to switch the tailstock forward/backward.

**Function description:**

When the tailstock control is invalid, the tailstock control M command alarms;

When the tailstock and the spindle control is interlocked, before the spindle is started, the system check whether the tailstock forward is valid. After the spindle is started, the tailstock backward cannot be executed.

**Parameter setting:**

PLC parameter: K13.0 1/0: tailstock control valid/invalid

PLC parameter: K13.1 1/0: the spindle rotation and the tailstock forward/backward are/not interlocked

**Note: The tailstock function is only for GSK 980TDc-V CNC system.**

### 3.2.7 Hydraulic control



: press it to switch the hydraulic motor ON/OFF in any mode.

**Function description:**

When the hydraulic control function is valid,  is pressed to control HPST output to start the hydraulic motor.

When the system is in non-run, the spindle stops and the speed is zero,  is pressed to close HPST output.

Parameter setting:

PLC parameter: K14.7 1/0: hydraulic control function valid/invalid

**Note: The hydraulic function key is only for GSK980TDc-V CNC system.**



### 3.2.8 Manual tool change



: In Manual mode, pressing the key can manually change tools in sequence (if current tool is No.1, it is changed for No.2 tool by pressing it; if current tool is No.4, it is changed for No.1 tool by pressing it).

### 3.2.9 Spindle override

In Manual mode, if the spindle speed is controlled by analog voltage output, the spindle speed may be overridden.

Pressing   can change the spindle speed in real-time to adjust 8 steps of 50%~120% of the spindle override.

## CHAPTER 4 MPG/STEP OPERATION

In MPG/Step mode, the machine moves by a specified increment.

**Note!**











The key functions of this GSK980TDc machine panel are defined by PLC program (ladders), please refer to the manuals by the machine builder for their significance.

Please note that the following description for the key functions in this chapter is based on the GSK980TDc standard PLC program!

**4.1 Step Feed**







Set the system parameter No.001 Bit3 to 0, and press  key to enter the STEP working mode, it displays as follows:

**4.1.1 Increment selection**

Press     to select the move increment, the increment will be shown in the page. When the BIT7(SINC) of K016 is 1,  step width value is inactive; when the BIT7 is 0,     are all active. For example, to press  key, the window is shown as follows:



### 4.1.2 Moving direction selection

Pressing  or  key once can move X negatively or positively by a step increment; pressing  or  key once can move Z negatively or positively by a step increment; pressing  or  key once can move Y negatively or positively by a step increment.

### 4.2 MPG(handwheel) Feed

Set the BIT3 of the system parameter No.001 to 1, and press  key to enter the MPG mode, it displays as follows:



The MPG figure is shown as follows:

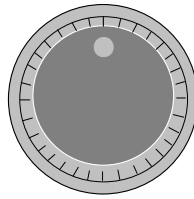

The handwheel (MPG) figure

### 4.2.1 Increment selection

Press key to select the move increment, the increment will be shown in the window. When the BIT7(SINC) of PLC K016 is 1, step is inactive; when BIT7 is 0, are all active. For example, to press key, the window is shown as follows:

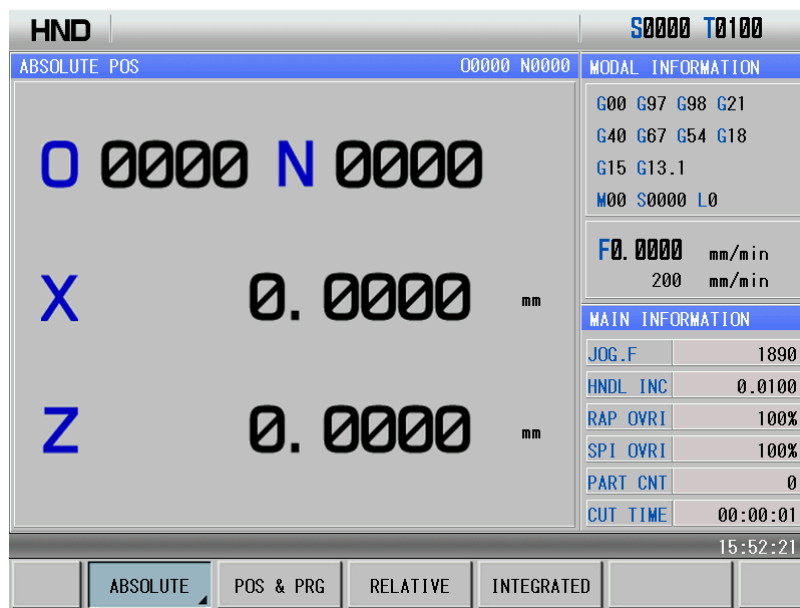

### 4.2.2 Moving axis and direction selection

In MPG mode, press key, the corresponding axis will be selected. For example, press key and the window is shown below:



The MPG feed direction is defined by its rotation direction. Generally, the MPG CW is for positive feed, and CCW for negative feed. In case of that MPG CW is for negative feed, CCW for positive feed, it may exchange the A, B signals of the MPG terminals. Bit0~Bit4 of NO. 013 selects the feed direction of MPG rotation.

### 4.2.3 Other operations

#### 1) Spindle CCW, CW, stop control



: In Manual mode, the spindle rotates counterclockwise if pressing this key;



: In Manual mode, the spindle stops if pressing this key;





: In Manual mode, the spindle rotates clockwise if pressing this key.

#### 2) Spindle Jog



: at the moment, the spindle is in JOG working mode.

In spindle Jog mode, pressing  can rotate counterclockwise for jogging; pressing  can rotate clockwise for jog. The jogging time and speed are set by DT12 and No.109 respectively. Referred to Section 3.2.2.

#### 3) Cooling control

Refer to OPERATION, Section 3.2.3

#### 4) Lubricating control

Refer to OPERATION, Section 3.2.4

#### 5) Chuck control

Refer to OPERATION, Section 3.2.5

#### 6) Tailstock control

Refer to OPERATION, Section 3.2.6

**7) Hydraulic control**

Refer to II OPERATION, Section 3.2.7

**8) Manual tool change**

: In MPG/Step mode, press it to change tools orderly.

**9) Spindle override tune**

In MPG/Step mode, if the spindle speed is controlled by analog voltage output, the spindle speed may be overridden.



Pressing S. OVERRIDE<sup>+</sup>, S. OVERRIDE<sup>-</sup> can change the spindle speed in real-time to adjust 8 steps of 50%~120% of the spindle override

**4.2.4 Explanation items**

The correspondence of the handwheel scale to the machine moving amount is as follows table:

MPG increment	Moving amount of each MPG scale			
	0.001	0.01	0.1	1
Specified coordinate value	0.001mm	0.01mm	0.1mm	1mm

(Taking example of the least input increment 0.001mm)

**Note 1:** The MPG increment is related to the system's current metric/inch input state and the system's least input increment.

**Note 2:** The MPG speed cannot be more than 5r/s, otherwise, the scale value is inconsistent with the movement amount.

## CHAPTER 5 MDI OPERATION

In MDI mode, the operations of parameter setting, code words input and execution can be performed.

### Note!

The key functions of this GSK980TDc machine panel are defined by PLC program (ladders), please refer to the manuals by the machine builder for their significance.

Please note that the following description for the key functions in this chapter is based on the GSK980TDc standard PLC program!

### 5.1 Block Input

Select MDI mode to enter PROGRAM->MDI page, to input an block G50 X50 Z100, the steps are shown below:

- 1) Press  key to enter MDI mode;
- 2) Press , and then press  to enter MDI program page below:



The page is shown as follows after above operations are completed:







## 5.2 Block Execution

After the word is input,  is pressed and the display is as follows:



After the code words are input and  is pressed to display the block,  key is pressed

to execute the input block. During the execution,  and  and Emergency Stop button may be pressed to terminate these code words execution.



**Note:** The subprogram call codes (M98 P\_ ; etc.), compound cutting cycle codes(G70, G71, G72, G73, G12.1, G7.1 and so on) is inactive in MDI mode.

## 5.3 Parameter Setting

In MDI mode, the parameter value can be altered after entering the parameter interface. The

detailed is referred to **OPERATION, Chapter 10.**

## 5.4 Data Alteration



In PRG->MDI page, if there is an error during words inputting before executing the input block,  is pressed to cancel the display to alter the program, or  is pressed to clear all the input, then correct re-inputting is executed.

## 5.5 Other Operations

### 1. Adjusting spindle override





In MDI mode, the spindle speed can be adjusted when the analog voltage output controls the spindle speed.



Pressing ,  can adjust the spindle override to change the spindle speed, which can realize the 8 steps adjustment in real-time from 50%~120%.



### 2. Adjusting rapid override



Pressing , , ,  can execute the rapid traverse, which can realize the 4 steps adjustment in real-time.

### 3. Adjusting feedrate



In MDI mode, pressing , ,  can adjust the feedrate override to change the feedrate, which can realize 16 steps adjustment from 0~150%.

### 4. Feedrate override is available.

## CHAPTER 6 PROGRAM EDIT AND MANAGEMENT

In Edit mode, a program can be created, selected, altered, copied and deleted, and the bidirectional communication of CNC to CNC, or CNC to PC can also be done.



To prevent the program to be altered or deleted accidentally, a program switch is set up for this GSK980TDc system. And it must be turned on before program editing. Please see details in Section 10.1.1 of the part.

The system provides multi-level user permission to facilitate the management. More than 4 levels (4 level, 3 level) can open the program switch to edit programs. See **OPERATION, Section 10.1.2**.

### 6.1 Program Creation

#### 6.1.1 Creating a block number

In the program, a block number can be added or not, the program is executed by the sequence. When the “AUTO SEG” switch in SWITCH SETTING window is OFF, CNC doesn’t generate the block number automatically, but the blocks may be numbered manually.

When the “AUTO SEG” switch in SWITCH SETTING window is ON, CNC generates the block number automatically, it automatically generates the next block number by pressing  or  in editing. The block number increment is set by the CNC data parameter No.042. (See details in **Section 10.1.1** of this part.)

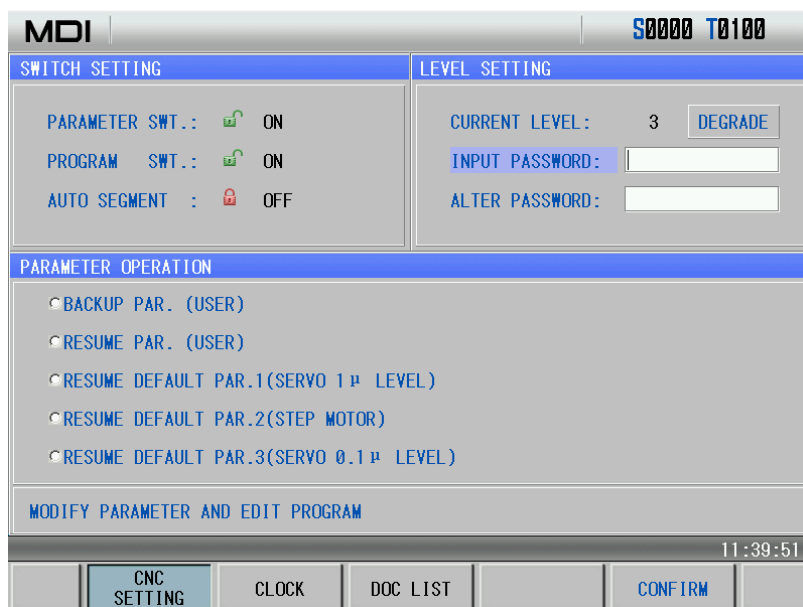

#### 6.1.2 Inputting a program

Press  to enter the Edit mode. Press  to enter the Program interface, create a machining program before inputting a machining program. The creating method is shown below:  
Method 1:

- 1) Press address key  , number key  ,  ,  and  key by sequence (e.g. taking an example of creating program O0001, the leading 0 can be omitted when its name is input). Its display is shown below:

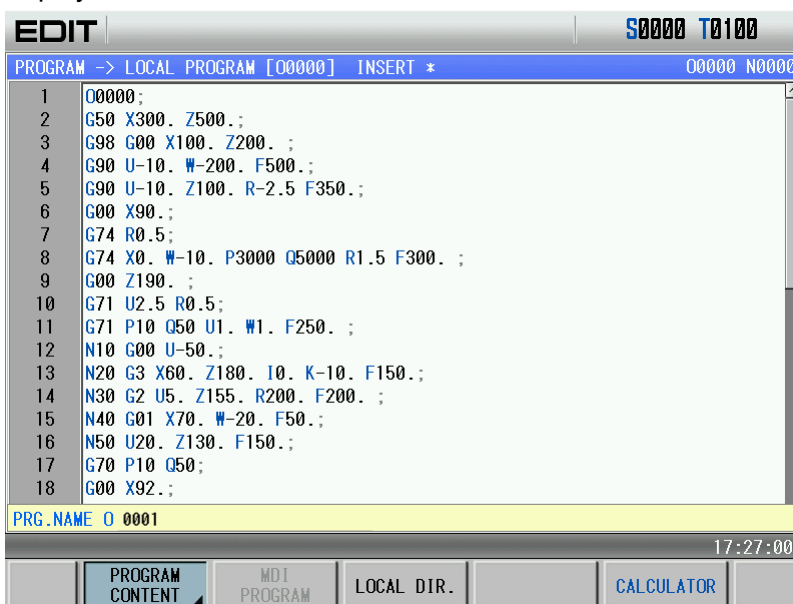

- 2) Press  (or ) to create the new program. The display is shown below:

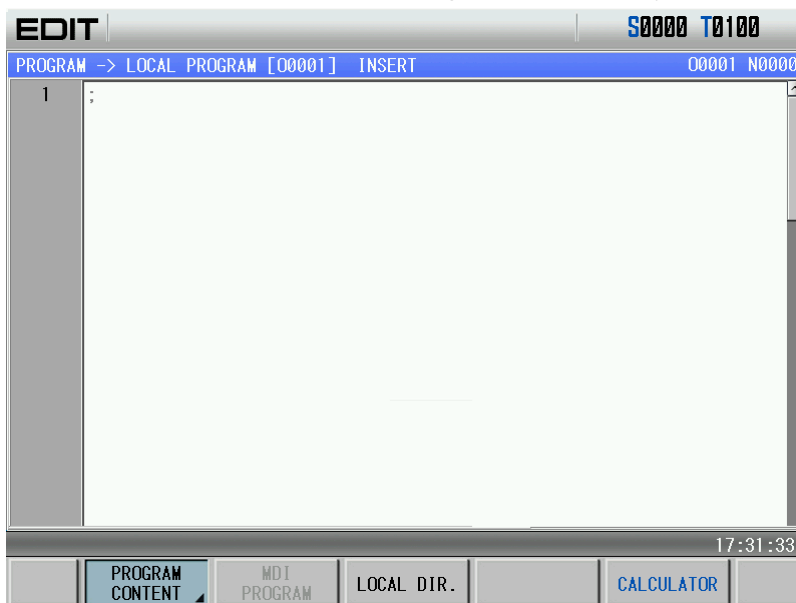

Method 2:

- 1) Press  (continuously press it twice when other page is displayed) to enter the local directory page. The display is shown below:



- 2) Press **NEW&OPEN**, input orderly , , ,  in the pop-up dialog box (taking example of creating O0001, the leading zero can be omitted when it is input) . It display is shown below:

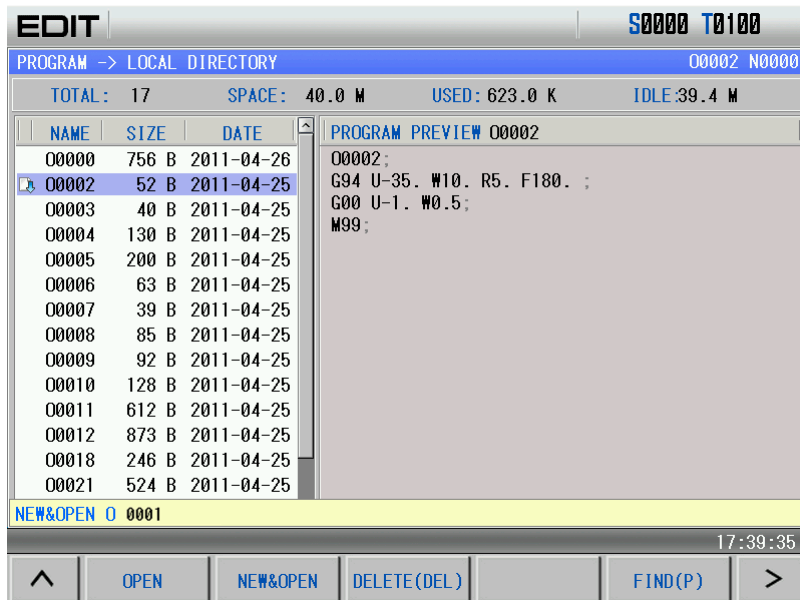

- 3) Press **EOB** (or **DATA INPUT**) to create the new program. The current page is automatically switched into the program content page. Its display is shown below:

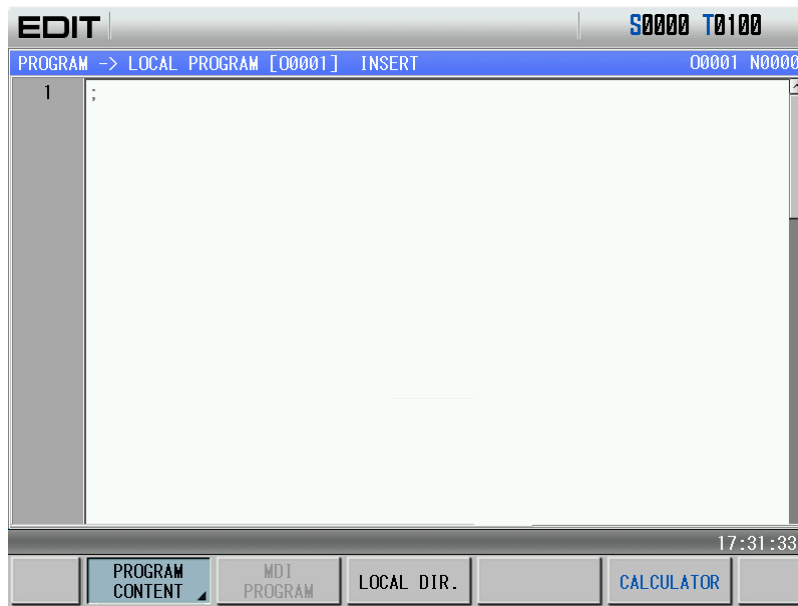

**Note:** When a program is needed to create, the input program name exists, the system opens the file, otherwise, it automatically create a new one.



Input the edited part program one by one, the character will be displayed on the screen immediately as it is input(as for compound key, press this key repeatedly for alternate input),



after a block is finished, press  or  to terminate it.



**Note:** The unexpected power-off when the program is input, the program being edited cannot be saved.

### 6.1.3 Searching a character

#### 1. Scanning: To scan the character one by one by cursor

1) Press  key to enter the Edit mode, then press  key to enter the PRG CONTENT window;

2) Press  key, the cursor shifts a row upward; if the number of the column where the cursor locates is over the total columns of the previous row, the cursor moves to the previous block end (at “;” sign) after  key is pressed;

3) Press  key, the cursor shifts a row downward; if the number of the column where the cursor locates is over the total columns of the next row, the cursor moves to the next block end (at “;” sign) after the  key is pressed;

4) Press  key, the cursor shifts a column to the right; if the cursor locates at the row end, it moves to the head of the next block;

5) Press  key, the cursor shifts a column to the left; if the cursor locates at the row head, it moves to the end of the next block;



6) Press  key to window upward, the cursor moves to the 1<sup>st</sup> row and 1<sup>st</sup> column of the

previous window, if it windows to the head of the program, the cursor moves to the 2<sup>nd</sup> row and 1<sup>st</sup> column;



7) Press  key to window downward, the cursor moves to the 1st row and 1st column of the next window, if it windows to the end of the program, the cursor moves to the last row and 1st column of the program;

## 2. Finding: To search for the specified character upward or downward from the cursor current location

The steps of finding is as follows:

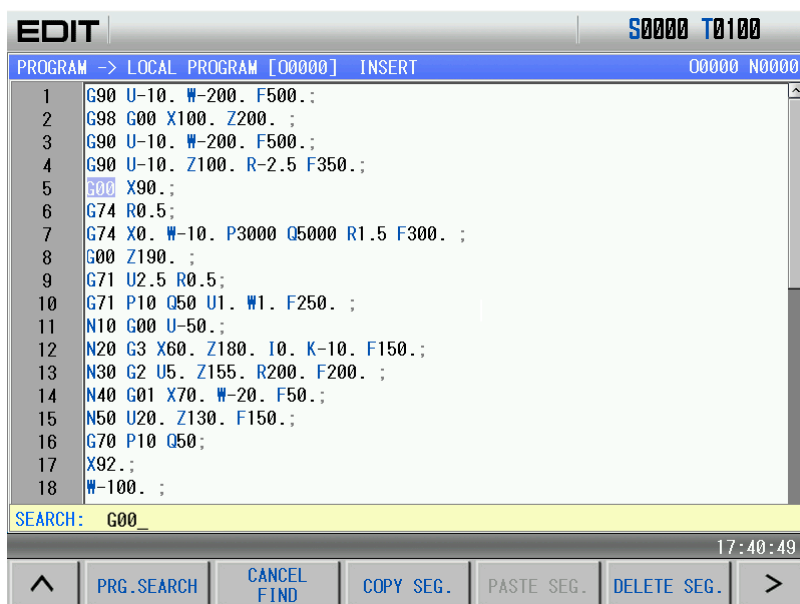
- 1) Press  to enter Edit mode, and press  key to enter the PRG CONTENT window;
- 2) Press , and input the required characters to be searched(can input one block). For example, finding "G00" page is shown below:



- 4) Press  key ( or ) is determined by the location of the character searched to the character where the cursor locates), it displays as follows:

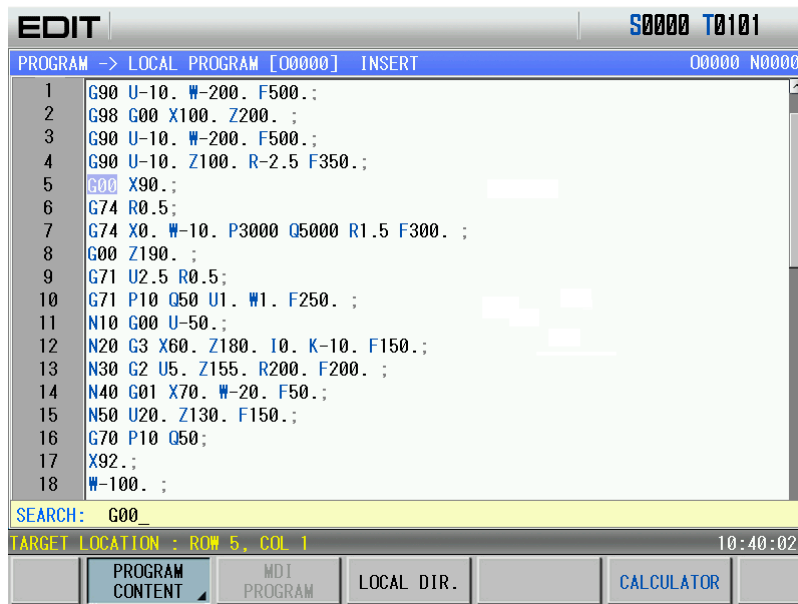

- 4) After the finding, the CNC system is still in FIND state, press or key again, the next character can be found. Or press key to exit the FIND state.
- 5) If the character is not found, the prompt of "Search fail" will be displayed.

**Note :** During the searching, it doesn't search the characters in the called subprogram, and the character in subprogram is searched in subprogram.

### 3. Positioning the cursor to the specified line

- 1) Press to enter Edit mode, and press to enter the PRG CONTENT page.
- 2) Press , and input the line number (the line number of block is the left of one row label). For example, the cursor positions to the 10<sup>th</sup> line, the display is shown below:

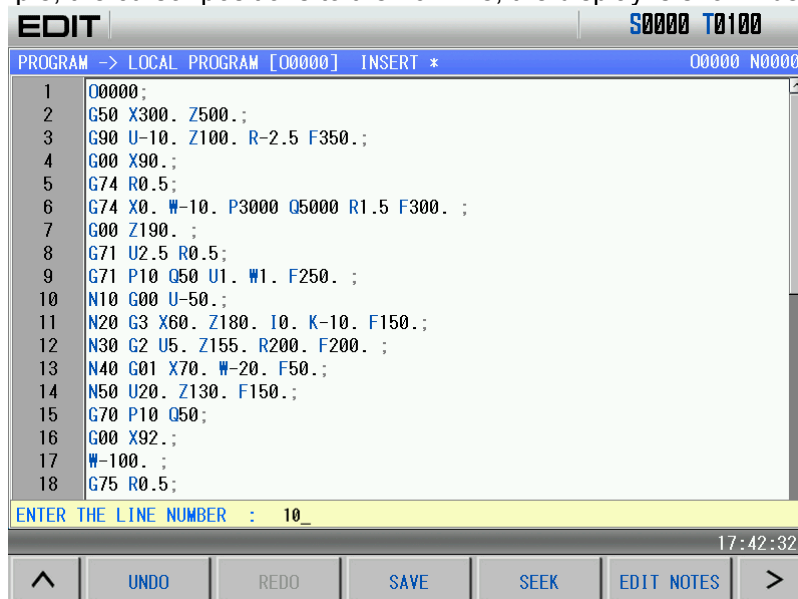

- 3) Press (or ), and the display page is shown below:



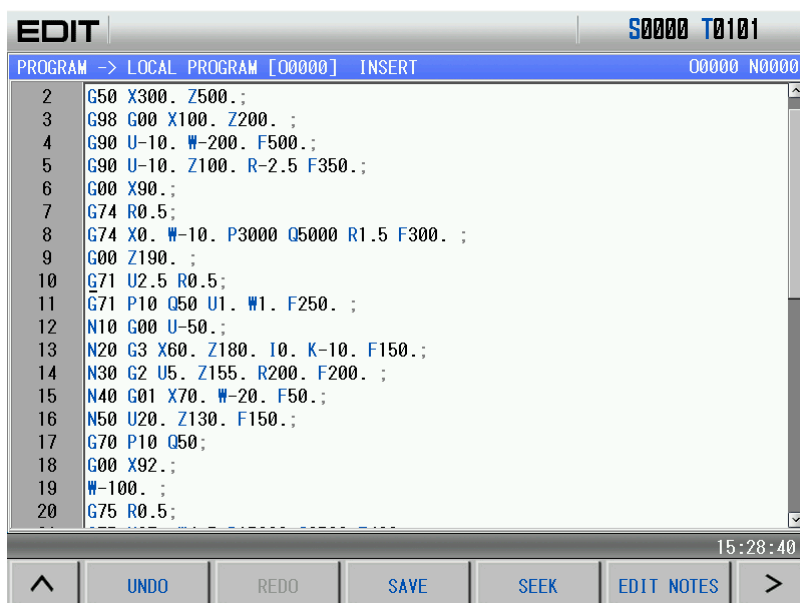



#### 4. The method to return to the program head



- 1) In Program interface of the Edit mode, press  key, the cursor returns to the program head;
- 2) Search the program head character by the methods in OPERATION, Section 6.1.3.

#### 6.1.4 Inserting a character

Steps:

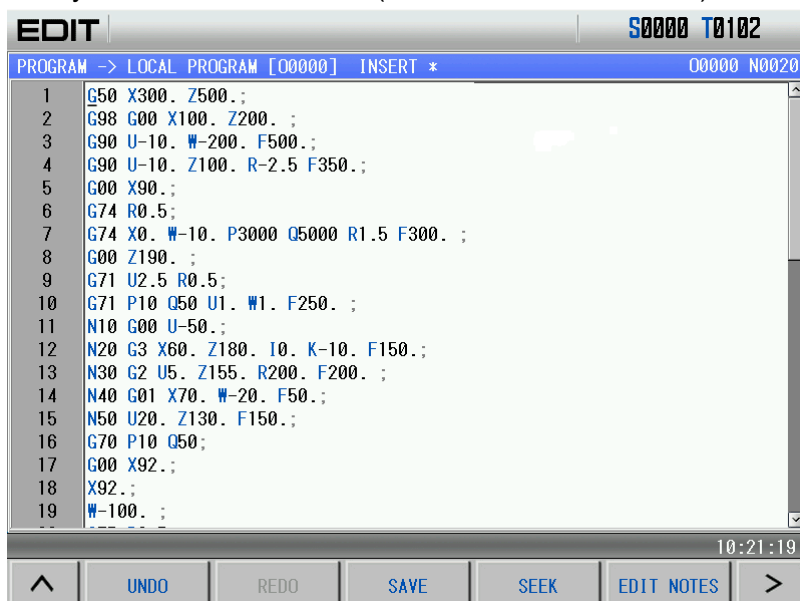
- 1) Press  to enter PRG CONTENT page in Edit mode;
- 2) Press  key to enter the INS mode (the cursor is an underline), the window is as follows:



- 3) Input the character to be inserted (to insert G98 code before G50 in the above figure, input , , ); it displays as follows:

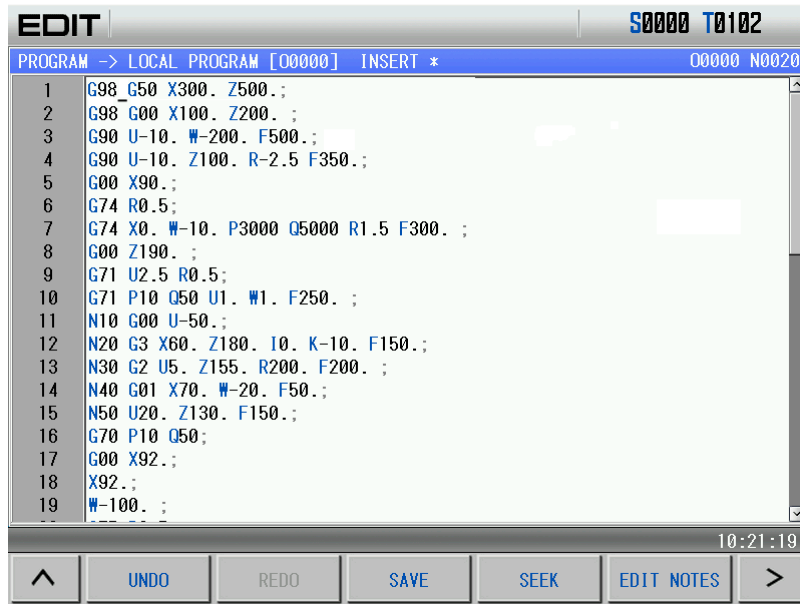

**Note 1:** In the Insert mode, if the cursor is not located at the row head, a space will be automatically generated when inserting the code address; if the cursor is located at the row head, the space will not be generated, and it should be inserted manually.

**Note 2:** In the Insert mode, if the previous bit before the cursor is a decimal point and the cursor is not located at the row end, input an address word, the "0" will be added automatically following the decimal point.

**Note 3:** In the Insert state, if the previous bit before the cursor is a decimal point and the cursor is not located at the row end, the "0" will be added automatically following the decimal point by pressing

**EOB** key.

### 6.1.5 Deleting a character

Steps:

- 1) Press **PROGRAM** to enter PRG CONTENT page in Edit mode;
- 2) Press **CANCEL** key to delete the character before the cursor; press **DELETE** key to delete the character where the cursor locates.

### 6.1.6 Altering a character

There are 2 methods for the character alteration:

**Insertion:** First delete the character altered by the methods in Section 6.1.5, then insert the character required by the methods in Section 6.1.5 of this part.

**Direct alteration:**

- 1) Select the PRG CONTENT page in Edit mode;
- 2) Press **INSERT ALTER** key to enter the ALT state (the cursor is a backlight rectangle), the display page is as follows:

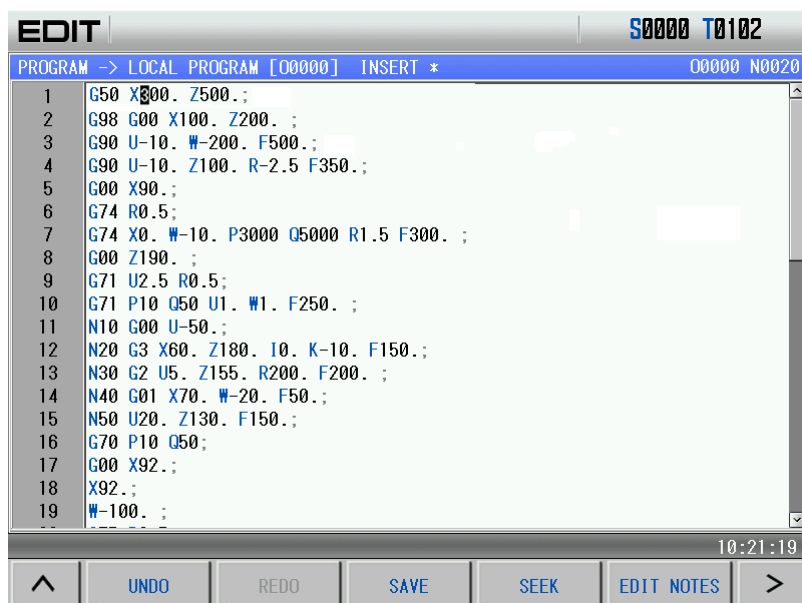

- 3) Input the modified character(as the above figure, alter X300 to X250, input , , ) , it displays as follows:

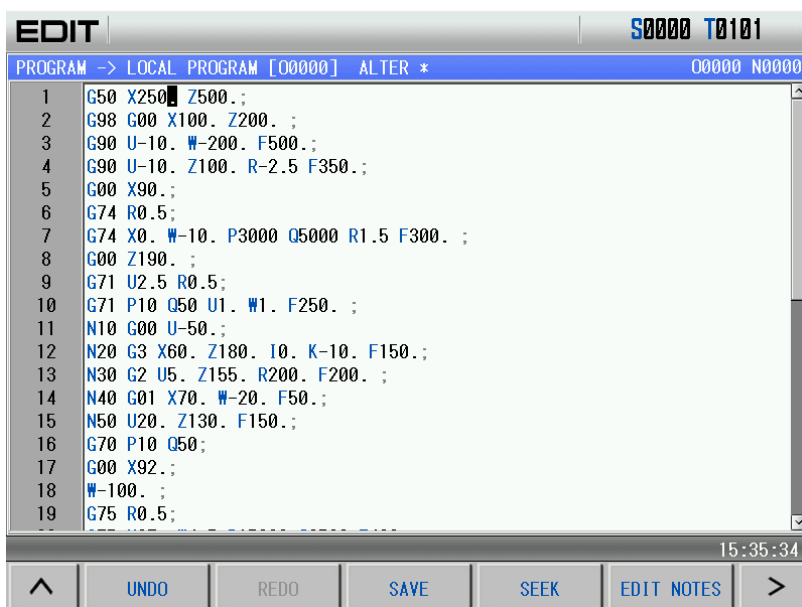

- Note 1:** In ALTER state, the current character where the cursor locates is altered for the input one, and the cursor moves a byte forward;
- Note 2:** In ALTER state, if the cursor is located at the “;” sign, the input character will substitute this sign, and the next block will shift upward a row.

### 6.1.7 Deleting a single block

Steps:

1) Press **PROGRAM** in Edit mode to enter program interface, and press **PROGRAM CONTENT** to enter program content page.

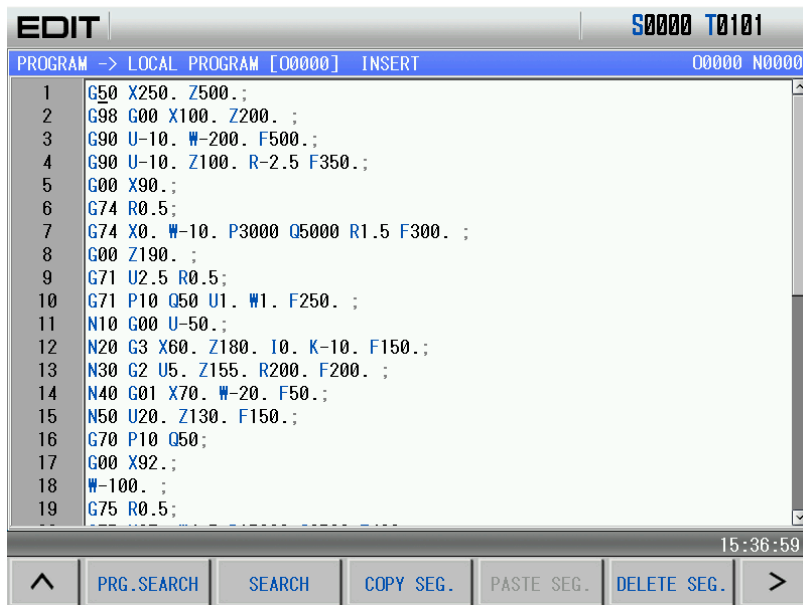

2) Move the cursor to the head of the block to be deleted, then press **DELETE** key.

### 6.1.8 Copying and pasting a block

Steps:

- 1) Select Edit mode, and the program content page is displayed;
- 2) Move the cursor to the required copy block, press **COPY SEG.**, and the current block is copied;
- 3) Move the cursor to the required paste position, press **PASTE SEG.**, and the copied block is pasted.

### 6.1.9 Canceling and recovering a program

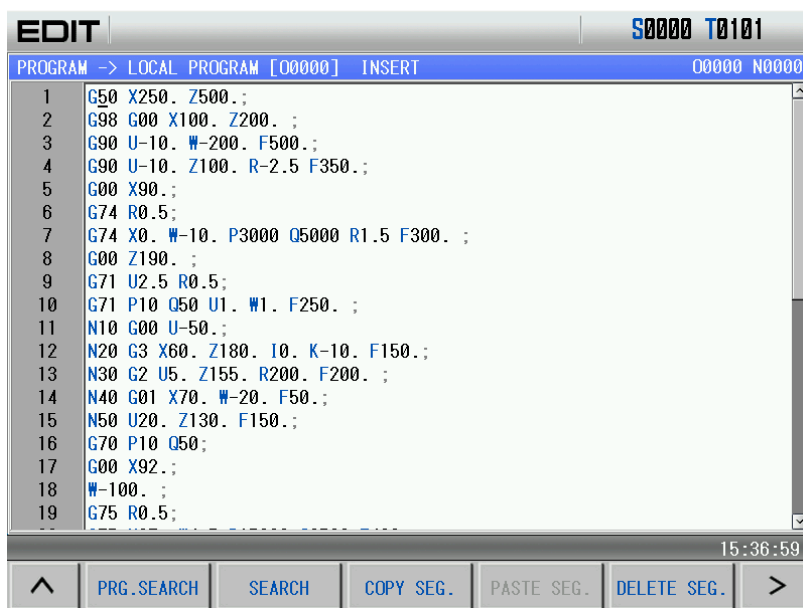

Steps:

- 1) Select Edit mode, the program content page is shown below:

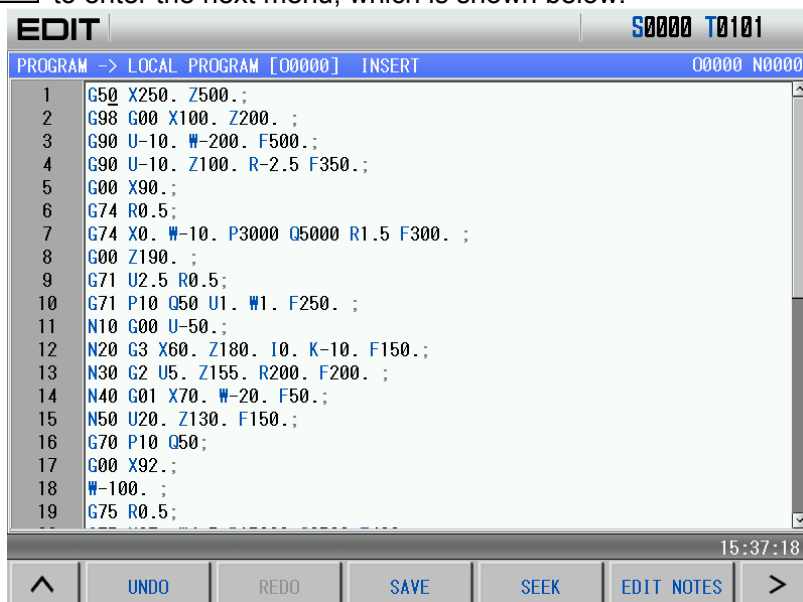

- 2) Press  to enter the next menu, which is shown below:





- 3) When the current content is changed(after modification, copy or deletion),  is pressed to recover the previous content before the copy;
- 4) Recover and cancel are matched. Press ,  to cancel the previous operation.

### 6.1.10 Program save

In Edit mode, after the program is edited or modified, although the system automatically save programs at regular time, the operator can select the operation to save the current program, which method is shown below:

Method 1:

In the program content page, press  to enter the next menu, press  to save the program into the CNC.

Method 2:

Switch the current display page and the CNC will automatically save the current program.

Note: “\*” in the title bar is displayed when the program is not saved.

### 6.1.11 Macro program edit

Press **INSERT** / **ALTER** key repeatedly, it enters MACRO state, as the following window shows:

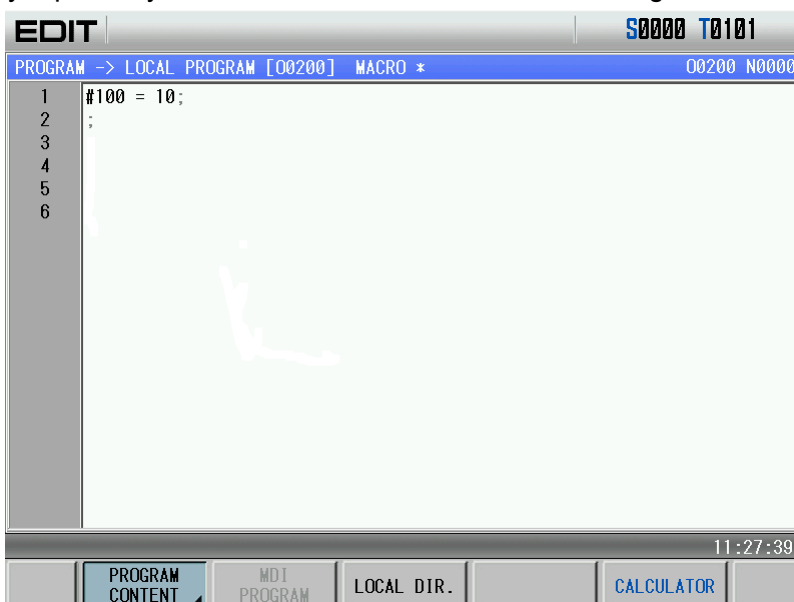

Then it may input some special characters ( [ , ] , = , > , < , + , \* ).

e.g. To input character “ [”, it may press **M<sub>[</sub>** key repeatedly.

**Note: The system cannot execute the program search and the scan in macro program edit state.**

### 6.1.12 Creating and modifying a program annotation

GSK980Tdc can add annotation to each line, and its steps are shown below:

- 1) Select Edit mode, press **CHANGE** to enter program interface, press **PROGRAM CONTENT** to enter the program content page;
- 2) Press **EDIT NOTES** and the CNC automatically insert “( )” into the end of line where the cursor is, and the display page is shown below:

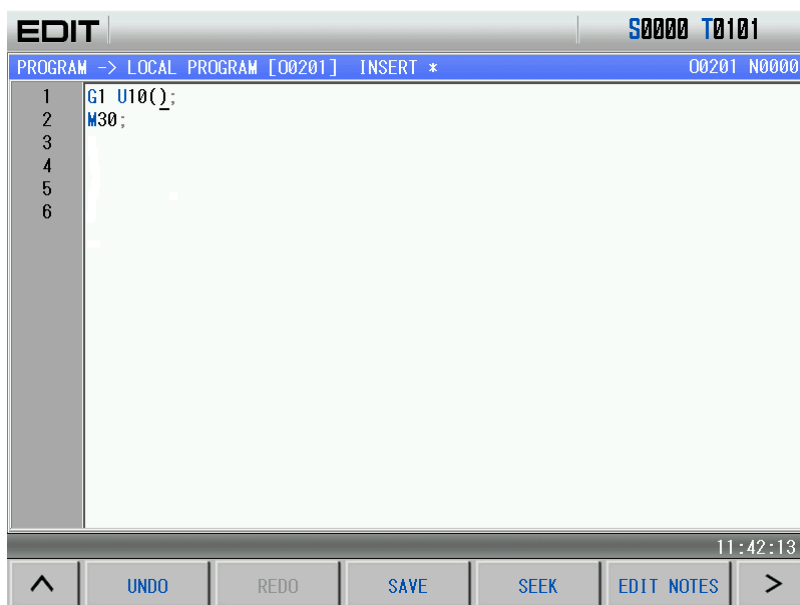

- 3) Input annotation character into "( ). For example, input "KUAI" character string, and the display page is shown below:

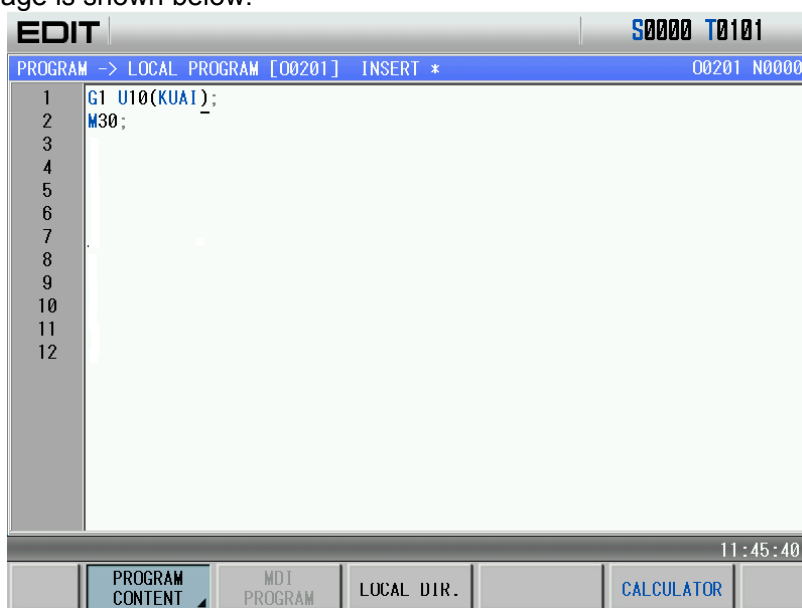



- 4) The modification of annotation is the same that of program content.

**Note :** The annotation added to the CNC could only be character. Actually, the CNC takes all content in "( )" as annotation, so, adding other annotation can be executed by using PC editing, and then be transmitted to the CNC.

## 6.2 Deleting Programs

### 6.2.1 Deleting a program

Steps:

- 1) Select Edit mode, press  to enter program interface, press  to enter program content page;

- 2) Press address key , number key , , , **1** by sequence (taking example of O0001);

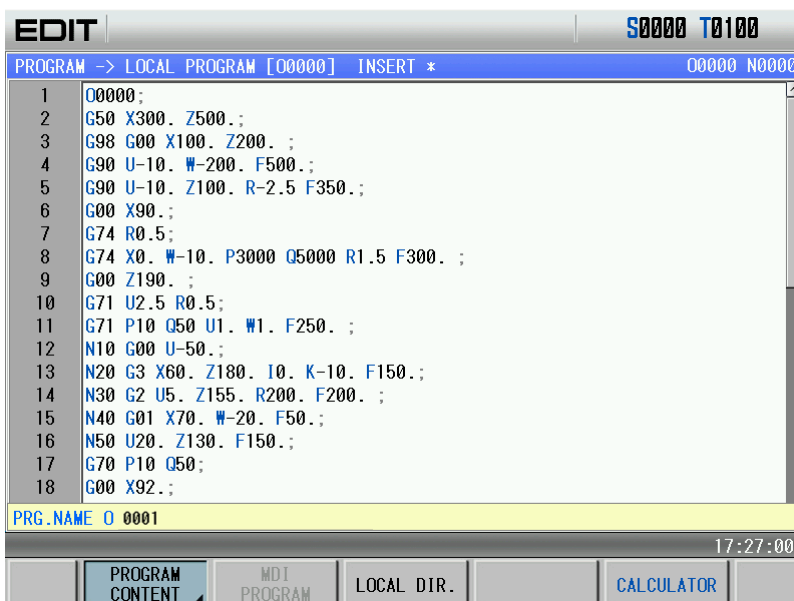

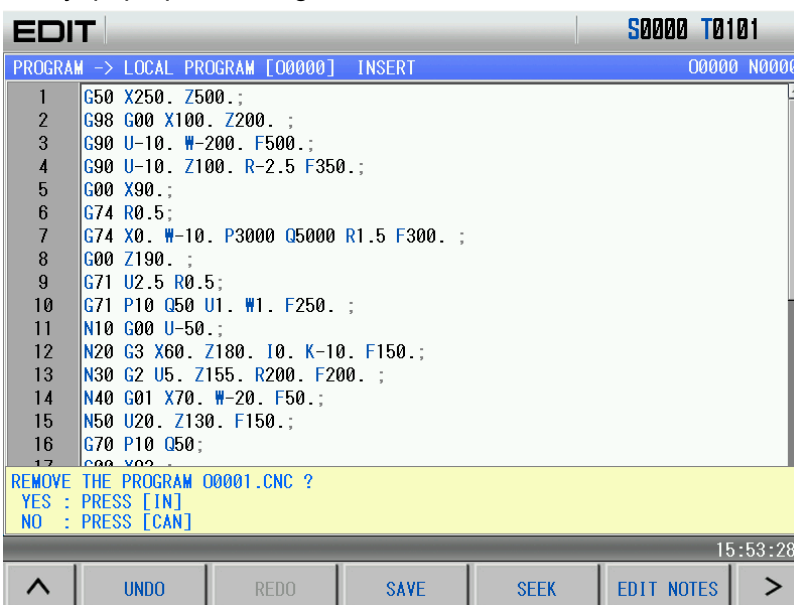

- 3) Press  key, pop-up the dialog box as follows:



- 4) Press  and O0001 program is deleted; press  and the deletion is cancelled.

Method 2:

- 1) Select Edit mode, press  to enter program interface, press to enter the local program page;

- 2) Press  or  to select the required deleted program. For example, select O0001 program and the display is shown below:



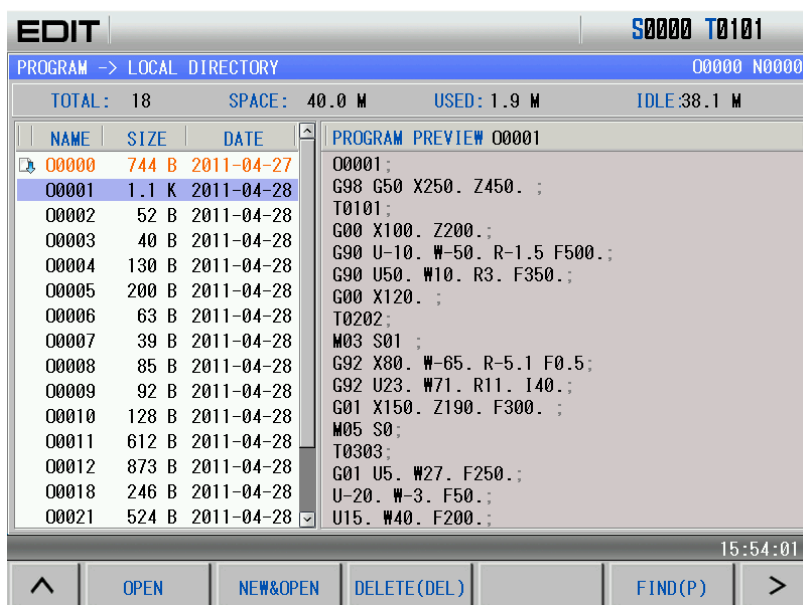

- 3) Press **DELETE** key, pop-up the dialog box as follows:

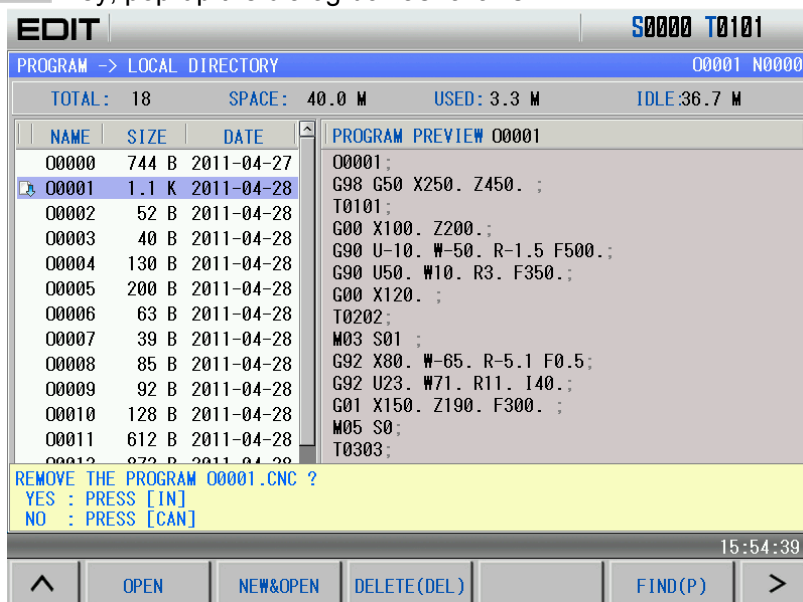

- 4) Press **DATA INPUT** and 00001 program is deleted; press **CANCEL** and the deletion is cancelled.

## 6.2.2 Deleting all programs

Steps:

- 1) Refer to Section 6.2.1, Method 2 to enter the local program page;
- 2) Press  to enter the next menu and the display is shown below:

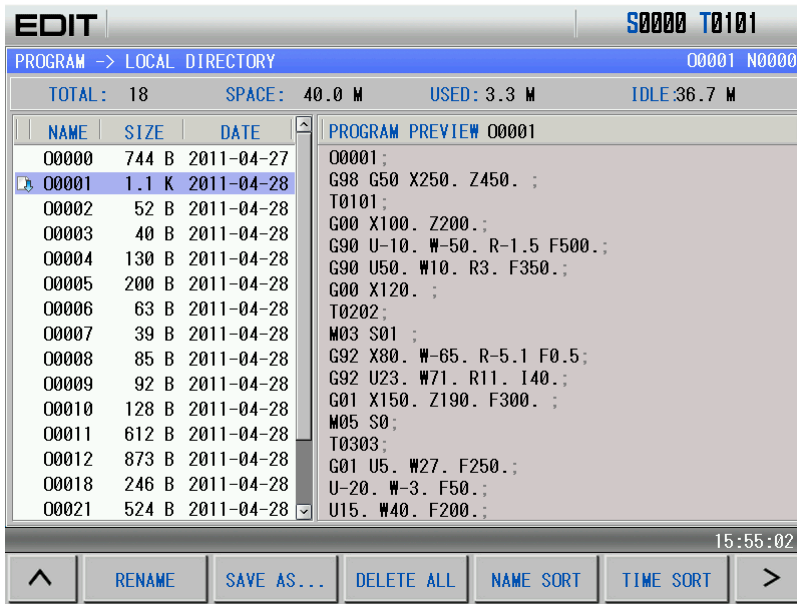

3) Press **DELETE ALL**, and then press **DATA INPUT**, the all program are deleted.

### 6.3 Selecting a Program

When there are multiple programs in CNC system, a program can be selected by searching, scanning and direct confirmation.

#### 6.3.1 Searching

- 1) Select Edit or Auto mode;
- 2) Press **PROGRAM**, **PROGRAM CONTENT** (the short key is ) and the display is shown below:

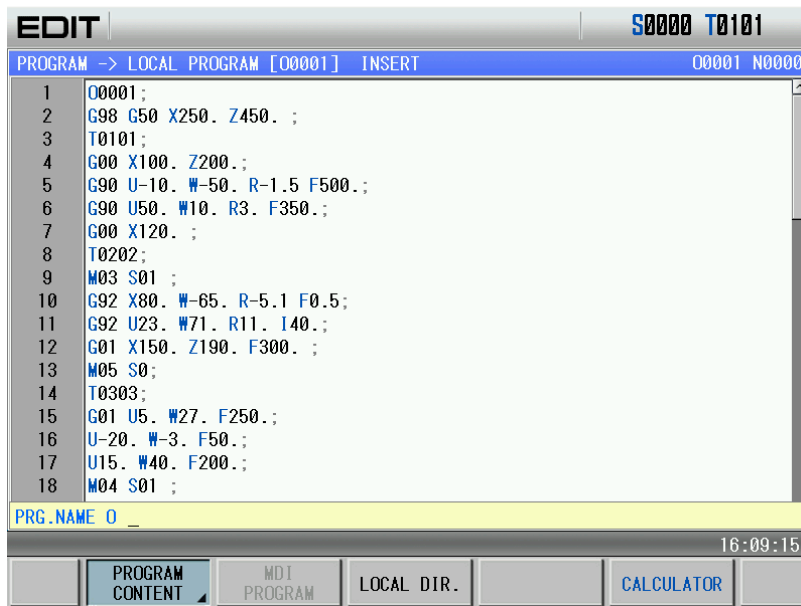

- 3) Press **PRG.SEARCH**, input the program number in the pop-up dialogue box. For example, search 00001 program (the leading zero can be omitted when the program name is input) and the display is shown below:

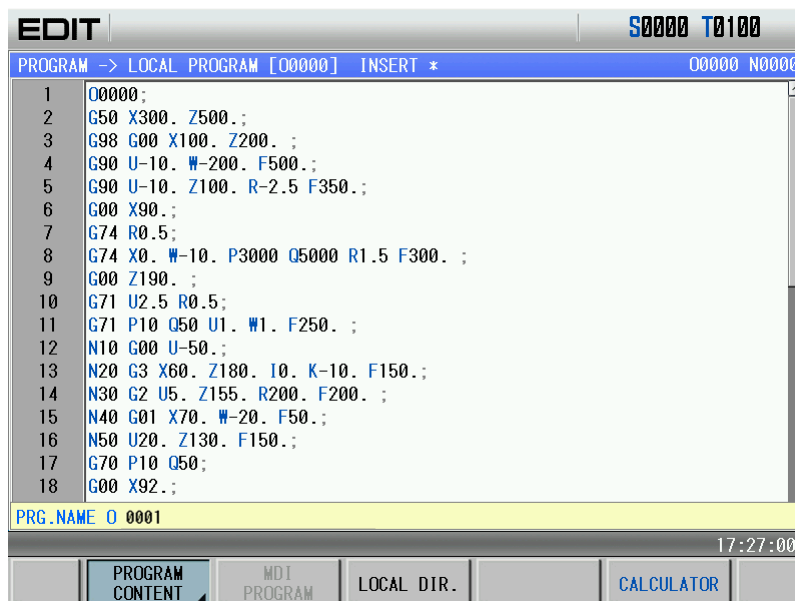

- 4) Press (or , , ), the searched program will be displayed. If the program does not exist, the CNC prompts “File does not exist”.

**Note:** In Edit mode, press or to search programs. When there is no programs, the CNC automatically creates programs; press or to execute the search, and the CNC prompts “The file does not exist” when there is not the program.

### 6.3.2 Scanning

- 1) Select Edit or Auto mode;
- 2) Press to enter the program display page;
- 3) Press ;
- 4) Press or to display the next or previous program;
- 5) Repeat step 3 and 4 to display the saved programs one by one.



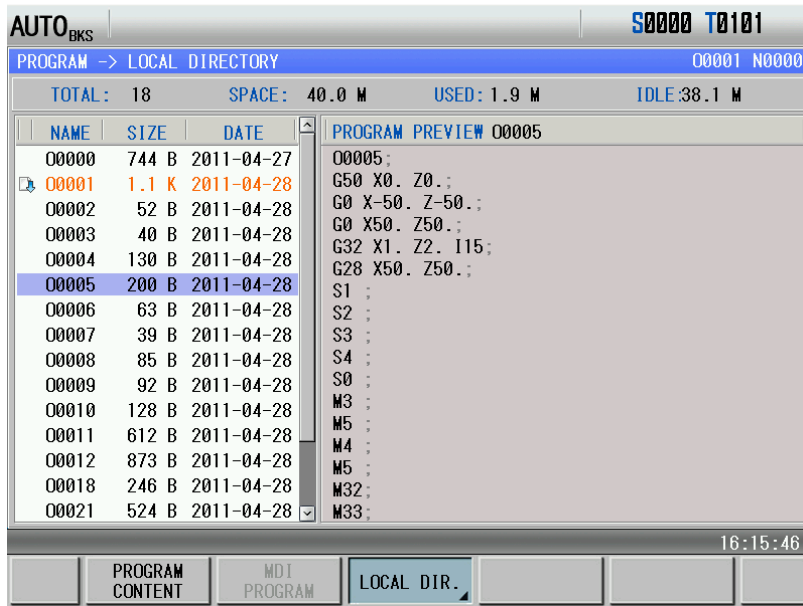

### 6.3.3 Direct confirmation

- 1) Select Edit or Auto mode (must be in non-run state);
- 2) Press to enter the program interface. When the system is not in “Local Directory” , is pressed, which displays is shown below:

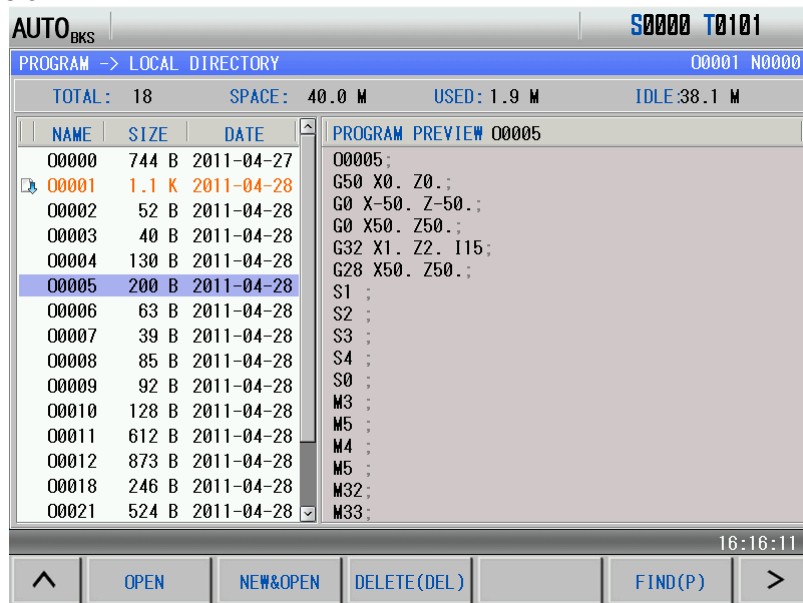

- 3) Pressing  can enter the subordinate menu, which can be omitted. The display is shown below:



- 4) Press ,  to move the cursor to the program name which is to be selected.
- 5) Refer to the above Step 3) to enter the subordinate menu, at the moment, press directly  to open it. The step can be omitted to execute the Step 6).
- 6) Press  or , and the selected program is opened and the CNC skips to “PRG. CONTENT” page.

Note: when the CNC is connected with the U disk, the above similar method is referred to open the program in the U disk.

## 6.4 Executing a Program

After the program to be executed is selected by the method in OPERATION, Section 6.3, select the

Auto mode, then press  key (or external cycle start key), the program will be executed

automatically.

## 6.5 Renaming a Program

Methods of renaming a program is divided into two:

Method 1:

- 1) Select Edit mode, press **PROGRAM** to enter the program interface, and in necessity press **PROGRAM CONTENT** to enter PRG CONTENT page (must be in Insert, Alter state):

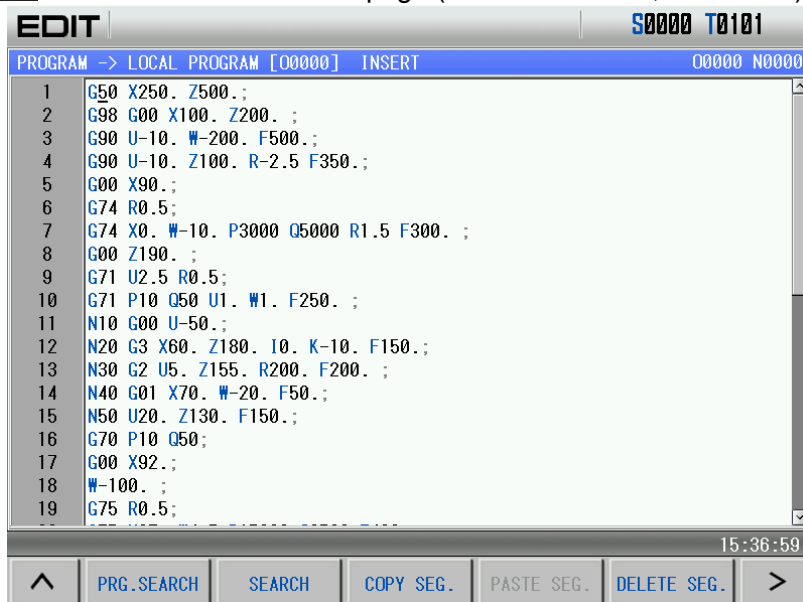



- 2) Press **□** to input a new program name;

- 3) Press **INSERT ALTER**.

Method 2:

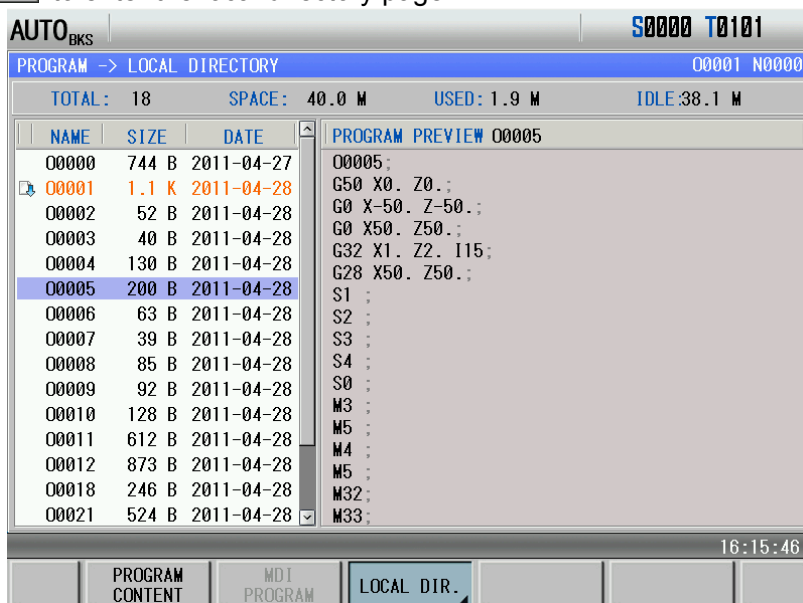
- 1) Select Edit mode, press **PROGRAM** to enter the program interface, and in necessity press **LOCAL DIR.** to enter the local directory page:



- 2) Press **LOCAL DIR.** again to enter the subordinate menu, and press  to open it:

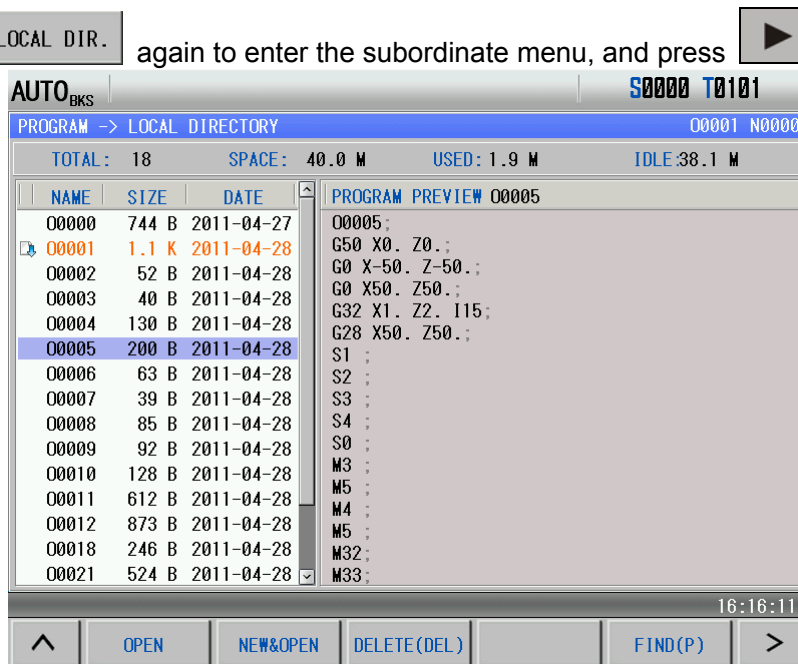

- 3) Move the cursor to the program which is to be modified, press **RENAME** and input a new program name in the pop-up dialog box, and at last press **DATA INPUT**.

Note: the method 1 is only used to the current program, and the method 2 is used to any programs.

## 6.6 Copying a Program

Methods of copying a program is divided into two:

Method 1:

- 1) Select Edit mode, press **PROGRAM** to enter the program interface, and in necessity press **PROGRAM CONTENT** to enter PRG CONTENT page (must be in Insert, Alter state):

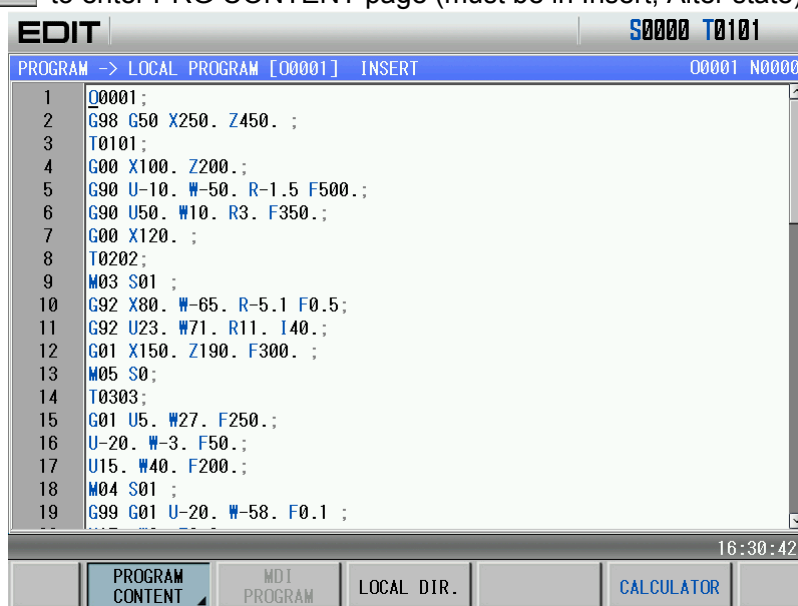

- 2) Press  to input a new program name;
- 3) Press **CHANGE**.

Method 2:

- 1) Select Edit mode, press **PROGRAM** to enter the program interface, and in necessity press **LOCAL DIR.** to enter the local directory page:

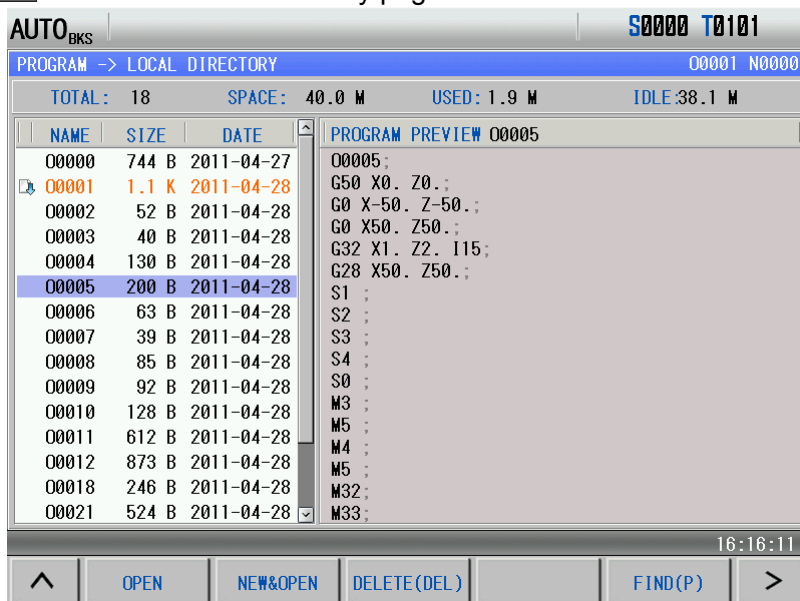

- 2) Press **LOCAL DIR.** again to enter the subordinate menu, and press **▶** to open it:

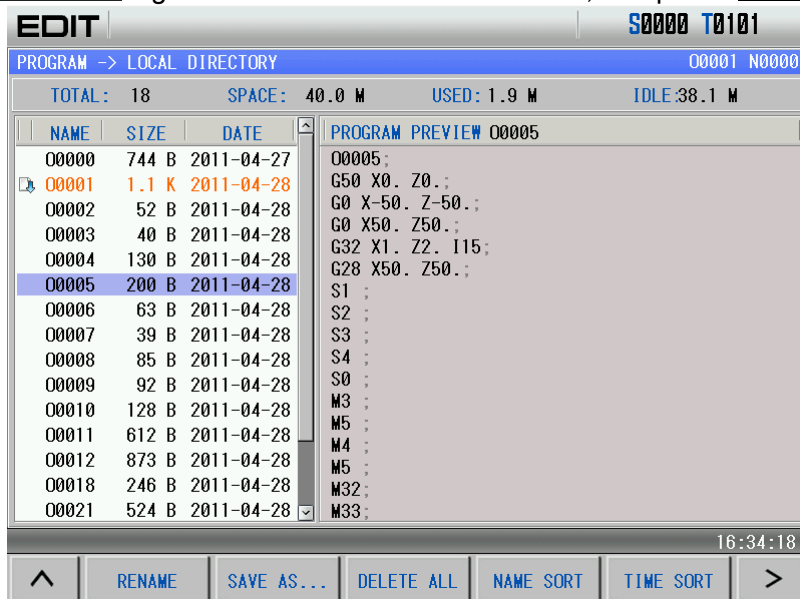



- 3) Move the cursor to the program which is to be modified, press **SAVE AS...** and input a new program name in the pop-up dialog box, and at last press **DATA INPUT**.

**Note:** the method 1 is only used to the current program, and the method 2 is used to any programs.

## 6.7 Program Management

### 6.7.1 Program list

Press **PROGRAM**, and then press **LOCAL DIR.** to enter the local program display page. In the page, it lists the program names saved in CNC system, and it can display up to 18 names in a page. When the saved exceed 18 programs, it may press  or  to display the next page.

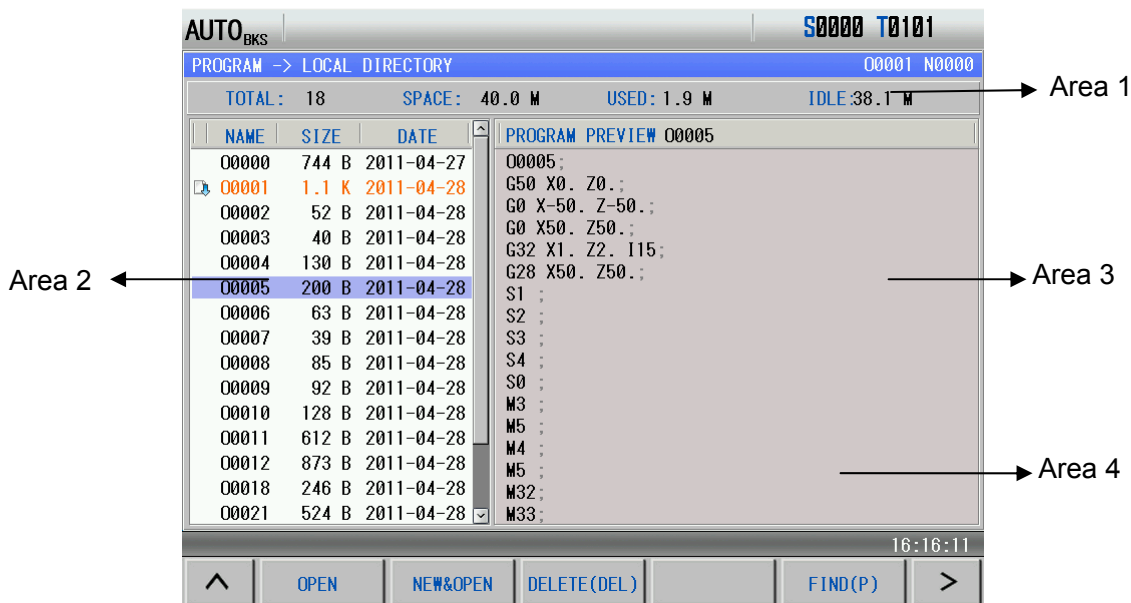





Explanations:

- 1) The area 1 is used to display the saved programs, the total memory capacity, the used capacity and the left;
- 2) The area is used to display the current program list;
- 3) The area 3 is used to preview the content of program where the current cursor is in the area 2;
- 4) The area 4 belongs to the soft function menu position. Pressing **NAME SORT** or **TIME SORT** can display in order programs located at the area 2.







## 6.8 Other Operations Available in Edit Mode

The operations by this GSK980TDc machine panel allowed in Edit mode are defined by ladders, please refer to the materials by the machine builder.

Please note that the following functions are described based on the 980TDc standard PLC programs!

- 1) Spindle override can be adjusted by pressing  or ;
- 2) Feedrate override can be adjusted by pressing  or ;
- 3) CNC can be reset by pressing **RESET** key;



- 4) The operation mode is switched by pressing any of the keys among  ,  ,  ,  ,  or  ;
- 5) The data transmission
- 6) Refer to II OPERATION, Chapter 12
- 7) Cooling control  
Refer to II Operation, Section 3.2.3
- 8) Lubricating control  
Refer to II Operation, Section 3.2.4
- 9) Chuck control  
Refer to II Operation, Section 3.2.5
- 10) Tailstock control
- 11) Refer to II Operation, Section 3.2.6
- 12) Hydraulic control  
Refer to II Operation, Section 3.2.7

## CHAPTER 7 TOOL OFFSET AND SETTING

The actual location of tool can be overlooked in programming for simplifying programming. Three methods including positioning toolsetting, trial toolsetting and machine zero toolsetting are available in this GSK980TDc system. The tool offset data are obtained from this toolsetting operation.

### 7.1 Tool Positioning Setting

Steps:

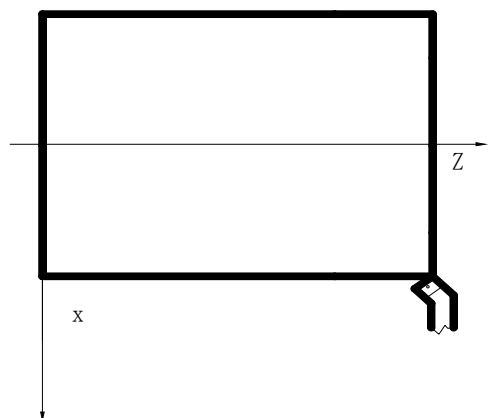

Fig. A

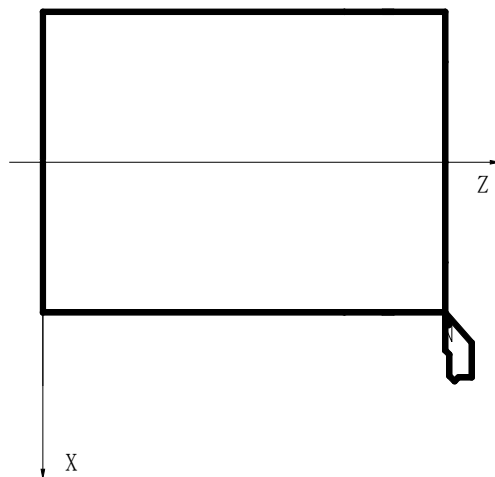





Fig. B

1. Firstly determine if the offset values are zero in X, Z, if not, clear all the tool number offset values;
2. Set the offset No. for 00 (i.e. T0100,T0300), as for the offset value: (method: execute a move code or perform the machine zero return in T0100 state, then clear the offset value automatically as returning to the machine zero);
3. Select a tool by random (usually the 1<sup>st</sup> tool, this tool will be used as the reference tool);
4. Position the tool nose of the reference tool to a point (toolsetting point), as shown in Fig. A;
5. In PRG STATE page of the MDI mode, set up the workpiece coordinate system by the command G50 X\_\_ Z\_\_;
6. Clear the relative coordinate (U, W), see details in APPENDIX;
7. After the tool is moved to a safety height, select another tool and move it to the setting point, as shown in Fig. B;
8. Press **OFFSET** key and move the cursor by ,  key to select the corresponding offset number of that tool;
9. Press address key , then press **DATA INPUT** key to input the tool offset value of X axis into the corresponding offset number;
10. Press address key , then press **DATA INPUT** key to input the tool offset value of Z axis into the corresponding offset number;
11. Repeat the steps from 7 to 10 to perform the toolsetting operation for other tools.

**Note:** For the fixed toolsetting, the original system tool offset should be cleared, input the new offset one time instead of many times by pressing **U**, **W**. Refer to II OPERATION, Section 7.5.4 about the tool compensation clearing method.

## 7.2 Trial Toolsetting

Whether the method of trial toolsetting is inactive is defined by the system parameter No.012 Bit5.

Steps (workpiece coordinate system by part end surface):

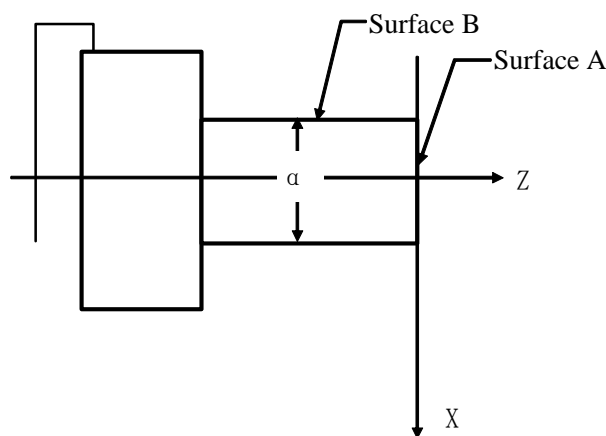

- 1) Select a tool by random and make it cut on Surface A;
- 2) Retract the tool along X axis without Z axis moving and stop the spindle; directly press **RECORD POSITION**, and the CNC records the absolute values of the position, at the moment, directly move the tool;

Press **OFFSET** key to enter the Offset interface, select the TOOL OFFSET page, then move

- 3) the cursor by pressing **↑**, **↓** key to select the corresponding offset number;
- 4) Key in by sequence the address key **Z**, number key **0** and **DATA INPUT** key;
- 5) Make the tool cut along Surface B;
- 6) Retract the tool along Z axis without the movement of X axis, and stop the spindle; directly press **RECORD POSITION**, and the CNC records the absolute values of the position, at the moment, directly move the tool;
- 7) Measure the diameter " $\alpha$ " (supposing  $\alpha=15$ );
- 8) Press **OFFSET** key to enter the Offset interface, select the TOOL OFFSET window, then move the cursor by pressing **↑**, **↓** key to select the corresponding offset number;
- 9) Key in the address key **X** by sequence, number key **1**, **5** and **DATA INPUT** key;
- 10) Move the tool to a safety height to change for another tool;

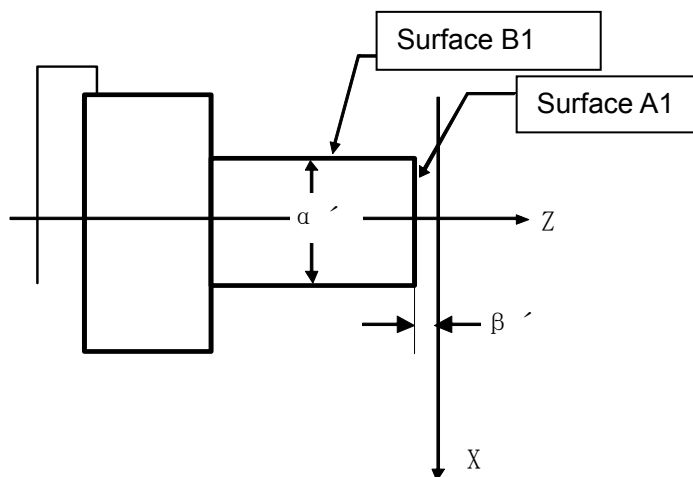

- 11) Make the tool to cut on Surface A1;
- 12) Retract the tool along X axis without Z axis moving and stop the spindle;
- 13) Measure the distance " $\beta'$ " between the Surface A1 and the workpiece coordinate origin (supposing  $\beta' = 1$ );
- 14) Press **OFFSET** key to enter the Offset interface, select the TOOL OFFSET page, then move the cursor by pressing **↑**, **↓** to select the corresponding offset number;
- 15) Key in by sequence the address key **Z**, sign key **-+**, number key **1**, and **DATA INPUT** key;
- 16) Make the tool to cut on Surface B1;
- 17) Retract the tool along Z axis without the movement of X axis, and stop the spindle;
- 18) Measure the distance " $\alpha'$ " (supposing  $\alpha' = 10$ );
- 19) Press **OFFSET** key to enter the Offset interface, select the TOOL OFFSET window, then move the cursor by pressing **↑**, **↓** to select the corresponding offset number;
- 20) Press orderly the address key **X**, number key **1**, **□** and **DATA INPUT** key;
- 21) Repeat the execution from Step 10 to Step 20 to perform the toolsetting operation for other tools.









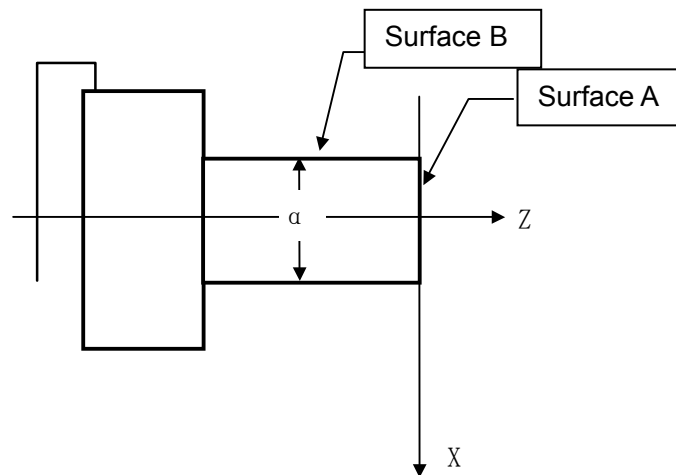





**Note:** The offset value may be large by this toolsetting method, so the tool compensation should be done by the coordinate offset by the CNC system. (set the BIT4 of the CNC parameter No.003 to 1). Moreover, the tool lengths compensation should be performed by using the T code in the 1st block, or the 1st move block should contain the T code for the tool length compensation.

### 7.3 Toolsetting by Machine Zero Return

There is no reference tool in this toolsetting methods, when the tool is worn or to be adjusted, it only needs to be set again, and a machine zero return should be done before the toolsetting. The machining could be continued by performing a machine zero return at power on after power-off, which is very convenient for the operation.

Steps (workpiece coordinate system by part end surface):



- 1) Press  key to enter Machine Zero mode, move axes to machine zero;
- 2) Select a tool by random and set the offset number of the tool to 00 (e.g. T0100, T0300) ;
- 3) Make the tool to cut on Surface A;
- 4) Retract the tool along X axis without the movement of Z axis, and stop the spindle; directly press , and the CNC records the absolute values of the position, at the moment, directly move the tool;
- 5) Press  key to enter the Offset interface, select the TOOL OFFSET window, then move the cursor by pressing ,  key to select the corresponding offset number;
- 6) Key in by sequence the address key , number key  and  key to set the offset value of Z axis;
- 7) Make the tool cut along Surface B;
- 8) Retract the tool along Z axis without the movement of X axis, and stop the spindle;
- 9) Measure the distance "α"(supposing α=15);
- 10) Press  key to enter the Offset interface, select the TOOL OFFSET window, then move the cursor by pressing ,  to select the corresponding offset number;
- 11) Key in by sequence the address key , number key ,  and  key to set the offset value of X axis;
- 12) Move the tool to a safety height for tool change;
- 13) Change for another tool, and set the tool offset number to 00 (i.e. T0100, T0300);

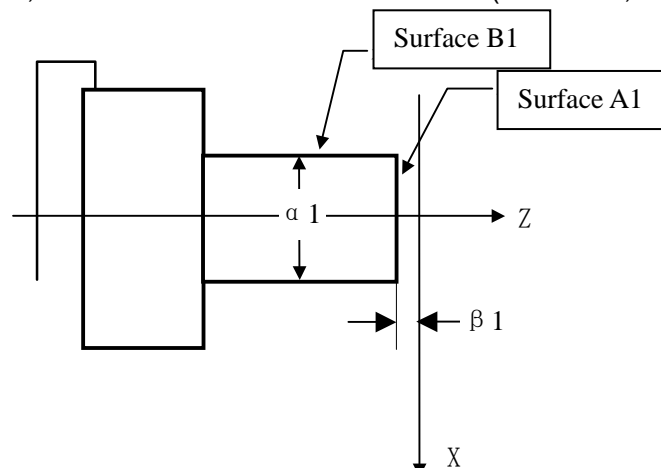

- 14) Make the tool to cut on Surface A1;
- 15) Retract the tool along X axis without Z axis moving and stop the spindle; measure the distance "β1" between the Surface A1 and the workpiece coordinate system origin (supposing β1=1);
- 16) Press **OFFSET** key to enter the Offset interface, select the TOOL OFFSET window, then move the cursor by pressing **↑**, **↓** to select the corresponding offset number;
- 17) Key in by sequence the address key **Z**, sign key **-**, number key **1**, and **DATA INPUT** key to set Z offset value;
- 18) Make the tool to cut on Surface B1;
- 19) Retract the tool along Z axis without the movement of X axis, and stop the spindle;
- 20) Measure the distance "α1" (supposing α1=10);
- 21) Press **OFFSET** key to enter the Offset interface, select the TOOL OFFSET window, then move the cursor by pressing **↑**, **↓** key to select the corresponding offset number;
- 22) Key in by sequence the address key **X**, number key **1**, **□** and **DATA INPUT** key to set X offset value;
- 23) Move the tool to a safety position;
- 24) Repeat the execution from Step 12 to Step 23 to perform the toolsetting operation for other tools.

- Note 1:** Machine zero switch must be fixed for the toolsetting operation by machine zero return.
- Note 2:** The workpiece coordinate system setting can't be done by G50 code after toolsetting by machine zero return.
- Note 3:** The tool compensation should be done by coordinate offset by the CNC system (the system parameter No.003 Bit4 is set to 1), further more, the tool lengths compensation should be performed by using the T code in the 1st block, or the 1st move block should contain the T code for the tool length compensation.
- Note 4:** The corresponding parameters should be set as follows:  
 Bit7=0 of the system parameter No.004;  
 Bit5=1 of the system parameter No.012;  
 Bit7=1 of the system parameter No.012.
- Note 5:** The setting values of the system parameter No.047 should be close to the absolute coordinate values of machine zero in workpiece coordinate system XOZ, as is shown in the following figure:

As shown below:

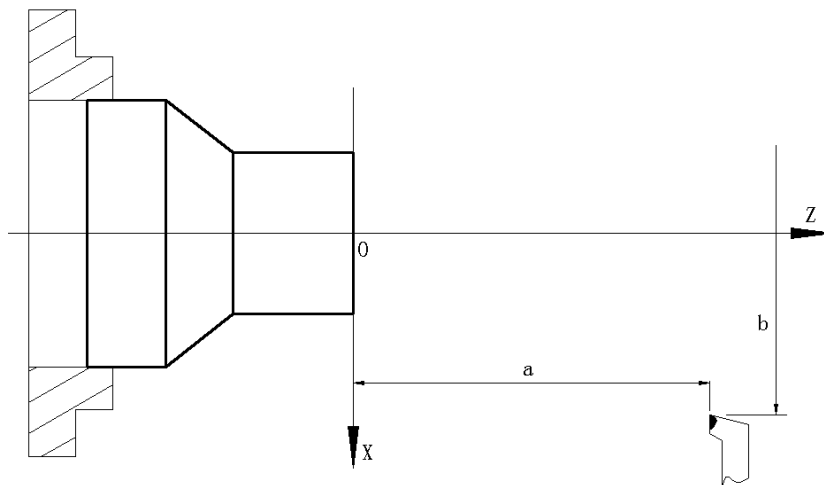

Example: After machine zero returning, when the absolute coordinate of the tool in workpiece

coordinate system is (a,b), the setting value of system parameter No.047 should be close to a,b.

### 7.4 Coordinates Record

When the trail-cut toolsetting or machine zero return toolsetting is executed, the coordinates record function can be used to get the convenient toolsetting operation.

When the toolsetting is executed and after the tool cuts along X (or Z), the following steps are executed to directly move the tool to the safety position as follows:

- 1) Press **OFFSET** to enter the tool offset interface, and then press **OFFSET&WEAR** to enter the tool offset page as follows:

EDIT						S0000 T0101	
TOOL -> OFFSET & WEAR						COORDINATES	
NO.		X	Z	R	T		
00	OFT	0.0000	0.0000	0.0000	0	[RELATIVE]	
	WEAR	0.0000	0.0000	0.0000	0	U	190.0000
01	OFT	0.0000	0.0000	0.0000	0	W	160.0200
	WEAR	0.0000	0.0000	0.0000	0	[ABSOLUTE]	
02	OFT	0.0000	0.0000	0.0000	0	X	190.0000
	WEAR	0.0000	0.0000	0.0000	0	Z	160.0200
03	OFT	0.0000	0.0000	0.0000	0		
	WEAR	0.0000	0.0000	0.0000	0		
04	OFT	0.0000	0.0000	0.0000	0		
	WEAR	0.0000	0.0000	0.0000	0		
05	OFT	0.0000	0.0000	0.0000	0		
	WEAR	0.0000	0.0000	0.0000	0		
06	OFT	0.0000	0.0000	0.0000	0		
	WEAR	0.0000	0.0000	0.0000	0		

16:49:48

RECORD X POSITION
RECORD Z POSITION
CLEAR ALL RECORD
FIND(P)

- 2) Press **RECORD POSITION**, absolute coordinates of X and Z (without including current tool offset values) are recorded in the CNC. After the absolute values are recorded correctly, there is a flash “Record coordinates” in the upper of the screen, and there is a prompt “Current Absolute coordinates have been recorded” in the bottom of the screen as follows:

MDI						S0000 T0101	
TOOL -> OFFSET & WEAR						COORDINATES	
NO.		X	Z	R	T		
00	OFT	0.0000	0.0000	0.0000	0	[RECORD POS]	
	WEAR	0.0000	0.0000	0.0000	0	X	250.0000
01	OFT	0.0000	0.0000	0.0000	0	[ABSOLUTE]	
	WEAR	0.0000	0.0000	0.0000	0	X	250.0000
02	OFT	0.0000	0.0000	0.0000	0	Z	450.0000
	WEAR	0.0000	0.0000	0.0000	0	A	0.0000
03	OFT	0.0000	0.0000	0.0000	0	B	0.0000
	WEAR	0.0000	0.0000	0.0000	0	C	0.0000
04	OFT	0.0000	0.0000	0.0000	0		
	WEAR	0.0000	0.0000	0.0000	0		
05	OFT	0.0000	0.0000	0.0000	0		
	WEAR	0.0000	0.0000	0.0000	0		
06	OFT	0.0000	0.0000	0.0000	0		
	WEAR	0.0000	0.0000	0.0000	0		



09:47:02

CLEAR X RECORD
RECORD Z POSITION
CLEAR ALL RECORD
CHANGE PAGE
FIND(P)

- 3) Retract the tool to the safety position, and stop the spindle. When the diameter is measured for the outer circle and the distance from the reference plane to it is done, the measured value is input in the tool offset page; the system counts the new tool offset value and sets it

to the selected tool offset number according to the input value and the previous recorded absolute coordinates.



Use the following methods to clear the recorded coordinates when the above methods are used to execute the toolsetting:

- 1) In the tool offset page, after the absolute coordinates are input in some tool offset(for example: Z0 is input in the No.01 tool offset number) and then the axis moves, the recorded coordinates are cleared;
- 2) Press  +  simultaneously, and the recorded coordinates are cleared;
- 3) Press  in the tool offset page and the recorded coordinates are cleared.

## 7.5 Setting and Altering the Offset Value





Refer to Section 1.3.3 about methods of entering the offset setting page.



### 7.5.1 Offset setting

- 1) Press  key to enter the offset setting page, select the desired window by pressing the  ,  ;
- 2) Move the cursor to the location of the tool offset, wear number to be input.

Scanning: Press  ,  to move the cursor in sequent

Searching: use the following press keys to directly move the cursor to the input position:

Press  + offset number +  or  and input the offset number in the pop-up dialogue box, press  and the cursor directly positions the target offset number.

- 3) After pressing the address key  or  , the numerical number may be keyed in (decimal point allowed);
- 4) Press  and the CNC calculates the offset value automatically and displays the result in the window.

### 7.5.2 Offset alteration

- 1) Refer to OPERATION, Section 7.5.1, and move the cursor to the location of the offset number that is to be altered;
- 2) If the offset value of X axis is to be altered, key in U; as for that of Z axis, key in W;;
- 3) Then key in the incremental value;
- 4) Press  to add the current offset value to the value keyed in, the operation result will be displayed as a new offset value.

Example: The set X axis offset value is 5.678



The increment keyed in is U 1.5

Then the new offset value is 7.178 (=5.678+1.5)

### 7.5.3 Offset alteration in communication mode

For the alteration and setting of the offset value in the communication, please see Chapter 12 of this part for its operations.

**Note 1:** While changing the offset value, the new offset value takes effect after the T code is executed.

**Note 2:** If the actual workpiece dimensions doesn't conform to that of the part drawing, subtract the error from the original offset value for the oversize workpiece, add the error to the original offset value for the undersize workpiece.

Example: The external diameter of the workpiece to be machined is  $\Phi 55.382$ , and the No.01 offset value is applied in the machining. Before machining, the values in No.01 are shown as follows table:

No.	X	Z	T	R
00	0	0	0	0
01	16.380	-24.562	0	0



In machining, the actual external diameter measured of workpiece is  $\Phi 55.561$ , so the offset value of No.01 can be altered as follows table:

No.	X	Z	T	R
00	0	0	0	0
01	16.201	-24.562	0	0

$$\longrightarrow 16.380 - (55.561 - 55.382)$$

**Note:** To backup and restore the tool offset values, the relevant operations may be performed on PC via communication.

### 7.5.4 Clearing the offset values

- 1) Move the cursor to the offset number to be cleared;
- 2) When the offset value of X axis is to be cleared,  is pressed, then  is done, the offset will be cleared. Other axis clearing is done like that;

**Note:** The offset clearing in the tool offset page doesn't mean that the system is under the state with no offsetting, if the system is needed to be in this state, the offsetting is required to be executed, which is shown as follows:

Execute a positioning command in T0100 state or perform a machine zero return. After the offsetting is finished, the "□□" in "T□□□" shown at the right bottom of the screen will not be backlighted.

### 7.5.5 Setting and altering the tool wear

To prevent the mistaken operation of the setting and alteration of the offset value (decimal point missed, mislocated etc.), which may cause the tool collision by oversize offset value, for the visual judgement for the tool wear by the operator, the TOOL WEAR window is set in this GSK980TDc system. When the offset value is needed to be altered due to the inaccurate dimensions by the tool wear, it may set or alter the wear value. The wear input range is defined by the data parameter No.140, and they are saved even at power down.

The setting and alteration methods for the tool wear are approximately identical to that of the tool offset, and the wear value is input by U(X axis), W(Z axis), V(Y axis).

### 7.5.6 Locking and unlocking the offset value

In order to protect the offset value to be operated by mistaken, the offset values can be put into lock, the operation steps are as follows:

- 1) Move the cursor to the location of the offset number to be locked;
- 2) Press the **CHANGE** key, the current offset value will be backlighted for locking, which is forbidden to alter, press the **CHANGE** key again, the locking may be cancelled. No.1 tool offset is locked as follows:

EDIT						S0000 T0100	
TOOL -> OFFSET & WEAR						O0000 N0000	
NO.		X	Z	R	T	COORDINATES	
00	OFT	0.0000	0.0000	0.0000	0	[RELATIVE]	
		-----	-----	-----			
01	OFT	0.0000	0.0000	0.0000	0	U	0.0000
	WEAR	0.0000	0.0000	0.0000	0	W	0.0000
02	OFT	0.0000	0.0000	0.0000	0	[ABSOLUTE]	
	WEAR	0.0000	0.0000	0.0000	0		
03	OFT	0.0000	0.0000	0.0000	0	X	0.0000
	WEAR	0.0000	0.0000	0.0000	0	Z	0.0000
04	OFT	0.0000	0.0000	0.0000	0		
	WEAR	0.0000	0.0000	0.0000	0		
05	OFT	0.0000	0.0000	0.0000	0		
	WEAR	0.0000	0.0000	0.0000	0		
06	OFT	0.0000	0.0000	0.0000	0		
	WEAR	0.0000	0.0000	0.0000	0		

11:01:26

**Note:** The tool wear values can't be locked.

### 7.5.7 No.0 tool offset moving workpiece coordinate system

When No.012 Bit 6 is set to 1, No. 0 tool offset moving workpiece coordinate system is valid.

After the value is input in No. 0 tool offset, the workpiece coordinate system executes the offset based on the input value.

MDI						S0000 T0101	
TOOL -> OFFSET & WEAR						O0002 N0000	
NO.		X	Z	R	T	COORDINATES	
00	OFT	0.0000	0.0000	0.0000	0	[RELATIVE]	
		-----	-----	-----			
01	OFT	0.0000	0.0000	0.0000	0	U	90.0000
	WEAR	0.0000	0.0000	0.0000	0	W	60.0200
02	OFT	0.0000	0.0000	0.0000	0		
	WEAR	0.0000	0.0000	0.0000	0		
03	OFT	0.0000	0.0000	0.0000	0	[ABSOLUTE]	
	WEAR	0.0000	0.0000	0.0000	0	X	90.0000
04	OFT	0.0000	0.0000	0.0000	0	Z	60.0200
	WEAR	0.0000	0.0000	0.0000	0		
05	OFT	0.0000	0.0000	0.0000	0		
	WEAR	0.0000	0.0000	0.0000	0		
06	OFT	0.0000	0.0000	0.0000	0		
	WEAR	0.0000	0.0000	0.0000	0		

11:56:45

OFFSET&WEAR    MACRO VAR.    OFFSET CD.    FIND(P)

Before inputting No.0 tool offset

MDI						S0000 T0101	
TOOL -> OFFSET & WEAR						O0002 N0000	
NO.		X	Z	R	T	COORDINATES	
00	OFT	100.0000	100.0000	0.0000	0	[RELATIVE]	
		-----	-----	-----			
01	OFT	0.0000	0.0000	0.0000	0	U	190.0000
	WEAR	0.0000	0.0000	0.0000	0	W	160.0200
02	OFT	0.0000	0.0000	0.0000	0		
	WEAR	0.0000	0.0000	0.0000	0		
03	OFT	0.0000	0.0000	0.0000	0	[ABSOLUTE]	
	WEAR	0.0000	0.0000	0.0000	0	X	190.0000
04	OFT	0.0000	0.0000	0.0000	0	Z	160.0200
	WEAR	0.0000	0.0000	0.0000	0		
05	OFT	0.0000	0.0000	0.0000	0		
	WEAR	0.0000	0.0000	0.0000	0		
06	OFT	0.0000	0.0000	0.0000	0		
	WEAR	0.0000	0.0000	0.0000	0		

12:01:11

OFFSET&WEAR    MACRO VAR.    OFFSET CD.    FIND(P)

After inputting No.0 tool offset

As the above figure, after X100, Z100 in No.0 tool offset is input, the workpiece coordinate system offsets X100, Z100.

**Note:** When No. 0 offset modification is valid real-time, No. 0 tool offset must be set before the system runs a program, otherwise, the run path will offset.

## CHAPTER 8 AUTO OPERATION

### Note!

The key functions of GSK980TDc machine panel are defined by PLC program (ladders), please refer to the materials by the machine builder for their significance.



Please note that the following description for the keys function in this chapter is based on GSK980TDc standard PLC program!

### 8.1 Automatic Run

#### 8.1.1 Selection of a program running

Refer to Section 6.3.

#### 8.1.2 Start of automatic run

1. Press  to select the Auto mode;
2. Press  to start the program, and the program automatically runs.

**Note:** Since the program execution begins from the block where the cursor locates, before pressing the

, make a check whether the cursor is located at the block to be executed.

#### 8.1.3 Stop of automatic run

##### ● Stop by code (M00)

1. M00

After the block containing M00 is executed, the auto run is stopped. So the modal function and state are all reserved. Press the  or the external run key, the program execution continues.

2. M01

Press  and the optional stop indicator is ON and the function is valid. After the block with M01 is executed, the system stops the automatic run, the modal function and the state are saved.

Press  or the external run key, and the program continuously runs.

##### ● Stop by a relevant key

1. In Auto run, by pressing  or external pause key, the machine keeps the following state:
  - (1) The machine feed slows down to stop;
  - (2) The modal function and state are reserved;

(3) The program execution continues after pressing the  key.

## 2. Stop by Reset key



(1) All axes movement is stopped.

(2) M, S function output is inactive (the automatic cut-off of signals such as spindle CCW/CW,

lubricating, cooling by pressing  key can be set by the parameters)

(3) Modal function and state is held on after the auto run.

## 3. Stop by Emergency stop button

If the external emergency button (external emergency signal active) is pressed under the dangerous or emergent situation during the machine running, the CNC system enters into emergency state, and the machine moving is stopped immediately, all the output (such as spindle rotation, cooling) are all cut off. If the Emergency button is released, the alarm is cancelled and CNC system enters into reset mode.

## 4. Switching operation mode

When Auto mode is switched to the Machine zero, MPG/Step, Manual, Program zero mode, the current block “dwells” immediately; when the Auto mode is switched to the Edit, MDI mode in Auto mode, the “dwell” is not displayed till the current block is executed.

**Note 1:** Ensure that the fault has been resolved before cancelling the emergency alarm.

**Note 2:** The electric shock to the device may be decreased by pressing the Emergency button before power on and off.

**Note 3:** The Machine zero return operation should be performed again after the emergency alarm is cancelled to ensure the correctness of the position coordinates (but this operation is forbidden if there is no machine zero in the machine).

**Note 4:** Only the BIT3 (MESP) of the bit parameter No.172 is set to 0, could the external emergency stop be active.



### 8.1.4 Automatic run from an arbitrary block

Press  key to enter the Edit mode, press  key to enter the program content page;

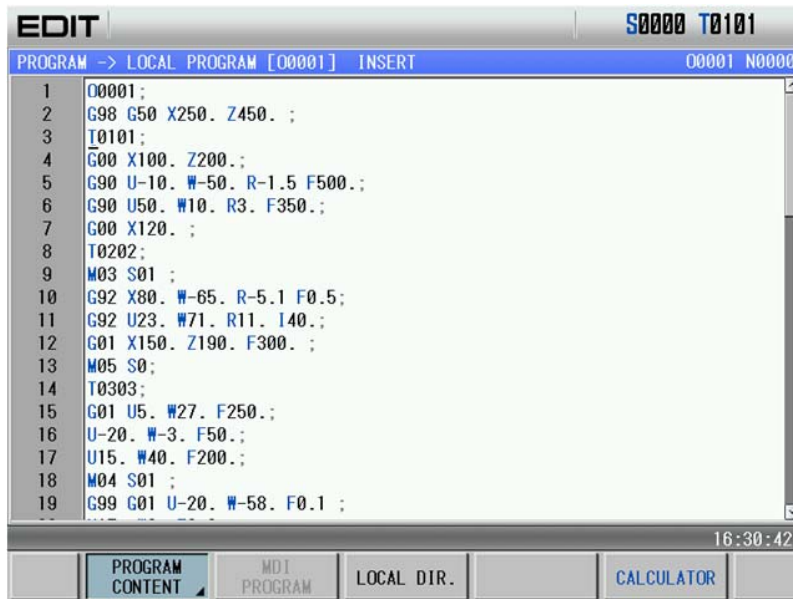
1) Move the cursor to the block to be executed (for example, move the cursor to the 3<sup>rd</sup> row head if it executes from the 3<sup>rd</sup> row);





2) If the mode (G, M, T, F code) of the current block where the cursor locates is defaulted and inconsistent with the running mode of this block, the corresponding modal function should be executed to continue next step.

3) Press  key to enter the Auto mode, then press  key to start the execution.

### 8.1.5 Adjustment of the feedrate, rapid rate

In Auto mode, the running speed can be changed by adjusting the feedrate override, rapid override. It doesn't need to change the settings of the program and parameter.

#### ● Adjustment of the feedrate override





Press    F. OVERRIDE, F. OVERRIDE, F. OVERRIDE 16-level real time feedrate can be obtained.

Note 1: The actual feedrate value is specified by F in feedrate override adjustment;

Note 2: Actual feedrate= value specified by F× feedrate override

#### ● Adjustment of rapid override

It can realize the F0, 25%, 50%, 100% 4-level real time rapid override adjustment by

pressing    .

Note 1: The rapid traverse speeds of X, Z axis are set by the system parameter No.022, No.023



X axis actual rapid traverse rate = value set by parameter No.022X×rapid override

Z axis actual rapid traverse rate = value set by parameter No.022Z×rapid override

Note 2: When the rapid override is F0, the min. rapid traverse rate is set by bit parameter No.032.

### 8.1.6 Spindle speed adjustment

While the spindle speed is controlled by the analog voltage output in Auto mode, it can be adjusted by spindle override.



Press   S. OVERRIDE, S. OVERRIDE to adjust the spindle override for the spindle speed, it can realize 8-level real-time override adjustment between 50%~120%.

**Note :** The actual output analog voltage = analog voltage by parameter × spindle override.

## 8.2 Running State

### 8.2.1 Single block execution

When a program is executed firstly, the system selects the single block run mode to avoid the program error to cause the unexpected.

Press  to select the single block run function in Auto mode; in single block mode, after the current block is executed, the CNC stops run; press  to execute the next block. Such repetition is executed till the program is done.

**Note 1:** The single block stops at the mid point of G28 code.

**Note 2:** For the single block state in the execution of canned cycle codes G90, G92, G94, G70~G76, refer to the 1st part PROGRAMMING.

**Note 3:** While the subprogram calling (M98\_\_ ), or subprogram calling return (M99) is being executed, the single block is inactive. But it is active except for N, O, P addresses in the block that contains M98 or M99 code.

### 8.2.2 Dry run

Before the program is to be executed automatically, in order to avoid the programming errors, it may select the Dry run mode to check the program.

In Auto mode, press  to enter the dry run state; in Dry run state, the machine feed and miscellaneous functions are both active (as machine lock, MST lock are both OFF), that means the dry run switch has nothing to do with the machine feeding, MST functions, so the feedrate by program is inactive and the CNC system runs at the speed described in the following table:

	Program command	
	Rapid traverse	Cutting feed
Rapid traverse switch ON	Rapid traverse	Max. manual feedrate
Rapid traverse switch OFF	Manual feedrate or rapid traverse(see note)	Manual feedrate

**Note 1:** The rate by manual feedrate or rapid rate is set by the BIT6 of the CNC system parameter No.004.

**Note 2:** The shift of rapid switch in Dry run mode doesn't affect the rate of the current block being executed, but that of the next block.

**Note 3:** The switch operation of Dry run is inactive if the ladder of this GSK980TDc is defined to be in auto running state (Auto, MDI mode).

### 8.2.3 Machine lock

In Auto mode, press  to enter the machine lock; the machine lock and MST lock are usually used together to check the program. While the machine is in the lock run state:

1. The machine carriage doesn't move, the "MACHINE" in the INTEGRATED POS window of the

Position interface doesn't vary too. The RELATIVE POS and ABSOLUTE POS, DIST TO GO are refreshed continuously, which is the same as that the machine lock switch is OFF.

2. M, S, T commands can be executed normally.

## 8.2.4 MST lock



In Auto mode, press  to enter the miscellaneous function lock state; The machine carriage moves without the M, S, T code being executed. The machine lock and MST lock are usually used together to check the program.

**Note:** When the MST lock is active, it takes no effect to the execution of M00, M29, M30, M98, M99.

## 8.2.5 Block skip

When a block in program is not needed to be executed and not to be deleted, this block skip function can be used. When the block is headed with “/” sign and Block skip indicator lights up (panel key active or external skip input active), this block is skipped without execution in Auto mode.



mode, press  to enter the state that the program skip is valid.

**Note:** While the block skip switch is off, the blocks headed with “/” signs are executed normally in Auto mode.

## 8.3 MPG Trial-cut

The user can use MPG trial-cut function after editing part programs, check the run path of program. In MPG trial-cut function, rotating MPG controls the execution speed of program, which can easily check the program error conveniently.

### 8.3.1 Switching MPG trial-cut mode



Press  to enter the MPG trial-cut mode after a machining program is selected as follows:



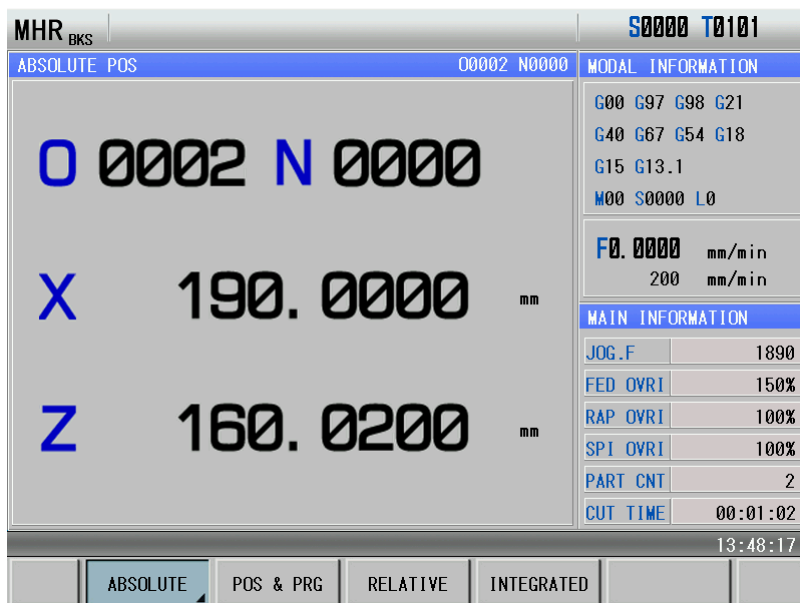

At the moment, press  and the display is shown below:

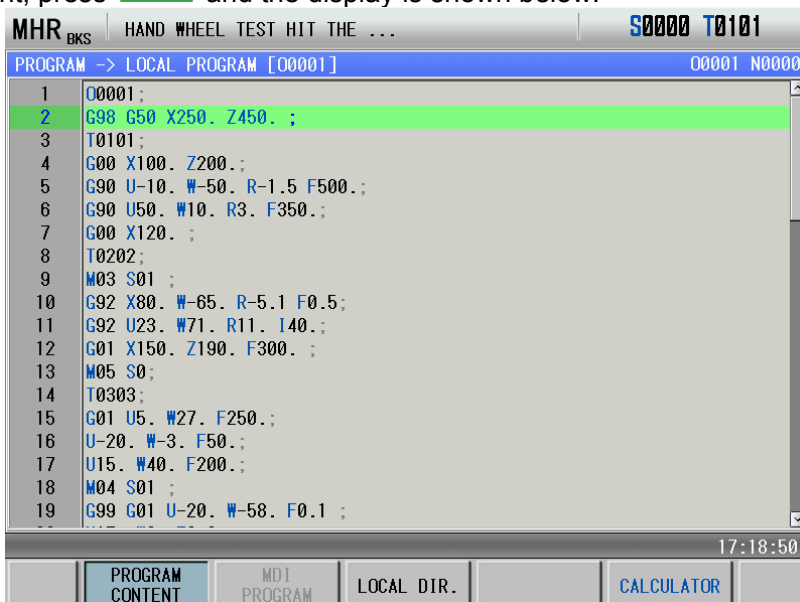

At the moment, rotating MPG makes the program start running. When the execution speed of program is proportional to MPG speed, execution speed of program fastens as soon as the MPG rapidly rotates; the execution speed slows down as soon as the MPG slowly rotates. Movement amount of one pulse can be adjusted by rapid override.

When the system is in the MPG trial-cut mode, it returns to Auto mode after  is pressed. All operations in MPG trial-cut mode are the same those of Auto mode.

### 8.3.2 Command speed in MPG trial-cut mode

#### 1) Cutting feedrate

Cutting command speed in MPG trial-cut mode is determined by No. 241 and rapid override. The command speed during actually rotating MPG is executed by the following:

$$[\text{Command speed}] \times [\text{MPG pulse amount per 1 second}] \times \lambda \times ([\text{the parameter setting value}] / 100) \times$$

(8/1000) (mm/min or inch/min)。

$\lambda$  value is determined by the current rapid override, and their relationship is:

Rapid override	$\lambda$ value	Rapid override	$\lambda$ value
F0	1	25%	10
50%	100	100%	100

Rapid traverse speed is clamped at 100% speed when it exceeds 100%, i.e.:

$$[\text{MPG pulse amount per 1 second}] \times \lambda \times ([\text{No.241 setting value}] / 100) \times (8/1000) \leq 1$$

2) Rapid traverse speed

Rapid traverse speed is clamped at the speed set by No.240, i.e.:

$$[\text{Rapid traverse speed}] = [\text{rapid traverse speed of each axis}] \times ([\text{No.240 setting value}] / 100) \times [\text{MPG pulse amount per 1 second}] \times \lambda \times ([\text{No.241 setting value}] / 100) \times (8/1000)$$

At the moment, when the speed by rapidly rotating MPG exceeds the clamped, the rapid traverse speed is clamped at the setting value by parameter, i.e.:

$$[\text{MPG pulse amount per 1 second}] \times \lambda \times ([\text{No.241 setting value}] / 100) \times (8/1000) \leq 1$$

### 8.3.3 Notes in MPG trial-cut mode

Pay more attention to the followings when the system is in MPG trial-cut mode:

- 1) Press  in Auto mode and the CNC does not switch to MPG trial-cut mode; when the CNC is in MPG trial-cut mode, it escapes the MPG trial-cut mode from the next block by pressing the mode switch key;
- 2) When the system executes the MPG trial-cut control, the single block signal and the feed hold signal are valid. When the single block or feed hold stops, the program execution state is recovered to the MPG trial-cut control after the cycle start key is pressed.
- 3) Execution speed of blocks for movement and pause can be controlled by rotating MPG. Their speed of blocks with M, S, T, F, i.e. without movement or pause cannot be controlled(except for executing the tool offset in traverse mode) by rotating MPG which only controls whether they are executed.
- 4) The spindle speed is not related to the MPG pulse. The spindle rotates with the commanded speed even if the system is in the MPG trial-cut mode. For feed per rotation, reading the current spindle speed is switched to the execution after feed per minute.

### 8.3.4 Temporarily invalid in MPG trial-cut mode

- 1) Executing screw cutting commands  
In the course of executing screw cutting blocks (G32, G32.1, G33, G34, G76, G84, G88, G92), the MPG trial-cut function is temporarily invalid with the speed under the override 100%, and is valid in the next block again. The MPG control is invalid when the screw cutting is executed actually, and it is valid in others.
- 2) Executing from the middle point to machine zero  
In the course of executing the block (G28, G30) from the middle point to machine, the MPG trial-cut is invalid temporarily and the block is executed with the speed under the override 100%, and the next block is valid again.
- 3) Measuring related G commands execution with the override 100%  
When the system measures the related G commands, the MPG trial-cut is invalid temporarily, is executed with the speed under the override 100%, at the moment, execution of

the next block is valid again. The related G commands include:  
G31, G36, G37

### 8.4 Other Operations

1. In Auto mode, press  key to switch on/off the cooling;

2. Press any of the  ,  ,  ,  ,  ,  ,  keys to switch the operation modes;

3. Press the  key to reset this CNC system.

4. Automatic lubricating operation (Refer to **OPERATION, Chapter 3**).

## CHAPTER 9 ZERO RETURN OPERATION

### Note!

The key functions of this GSK980TDc machine panel are defined by PLC program (ladders), please refer to the manuals by the machine builder for their significance.

Please note that the following description for the panel key functions in this chapter is based on the GSK980TDc standard PLC program!

### 9.1 Program Zero Return

#### 9.1.1 Program Zero

While the part is fixed on the machine, absolute coordinate of current tool position may be set by G50 code according to the relative position between the tool and the part, so a workpiece coordinate system is setup. The tool current position is called **program zero**, and this is the program zero return position.

#### 9.1.2 Program zero return steps

1. Press  key, it enters the Program zero return mode, the bottom line of the window displays "P. ZERO":



2. Press the direction key of X, Z, Y, 4<sup>th</sup>, C axis, it returns to the program zero of X, Z, Y, 4<sup>th</sup> or C axis;
3. The machine axis moves toward the program zero return, and the axis stops with the program zero return completion indicator ON after the axis returns to the program zero.

**Note 1:** The tool offset is not changed for the program zero return operation, if there is offset, the return position is the point set by G50.

**Note 2:** Whether the key is held on at program zero return is defined by the bit parameter No.011 BIT2 (zero return is locked automatically).

## 9.2 Machine Zero Return

### 9.2.1 Machine Zero

The **machine coordinate system** is a reference coordinate system for CNC coordinate operation. It is an inherent coordinate system of the machine. The origin of the machine coordinate system is called machine zero (or machine reference point). It is defined by the zero or zero return switch fixed on the machine. Usually this switch is fixed at the positive stroke point of each axis.

### 9.2.2 Machine Zero return steps

1. Press  key, it enters the Machine zero mode, the bottom line of the window displays "REF":



2. Press , , ,  or  key to return to the machine zero of X, Z, Y, 4th or C axis;

3. The machine axis returns to the machine zero via the deceleration signal, zero signal detection. At the machine zero, the axis stops, and the corresponding machine zero return completion indicator lights up.

**Note 1:** If there is no machine zero on the machine, the machine zero operation is forbidden;

**Note 2:** The machine zero finish indicator is gone out on condition that: 1)The axis is moved out from machine zero; 2) CNC is powered off.

**Note 3:** After the machine zero operation, the tool length compensation is cancelled by CNC;

**Note 4:** Parameters related to machine zero return are referred to INSTALLATION and CONNECTION.

**Note 5:** After the machine zero return is executed, the original workpiece coordinate system is set again with G50.

### 9.3 Other Operations in Zero Return

- 1) The spindle rotates (CW, CCW), stops.
- 2) The cooling is ON or OFF.
- 3) The lubricating control.
- 4) Manual relative tool change.
- 5) The spindle override tuning.
- 6) Rapid override tuning.
- 7) Feedrate override tuning.
- 8) Hydraulic chuck control (be applied to only GSK980TDc-V);
- 9) Hydraulic tailstock control (be applied to only GSK980TDc-V).

## CHAPTER 10 DATA SETTING

## 10.1 Data Setting

Press **SETTING** and then **CNC SETTING** to enter the CNC setting page which includes the switch setting, level setting and parameter operation function as follows:

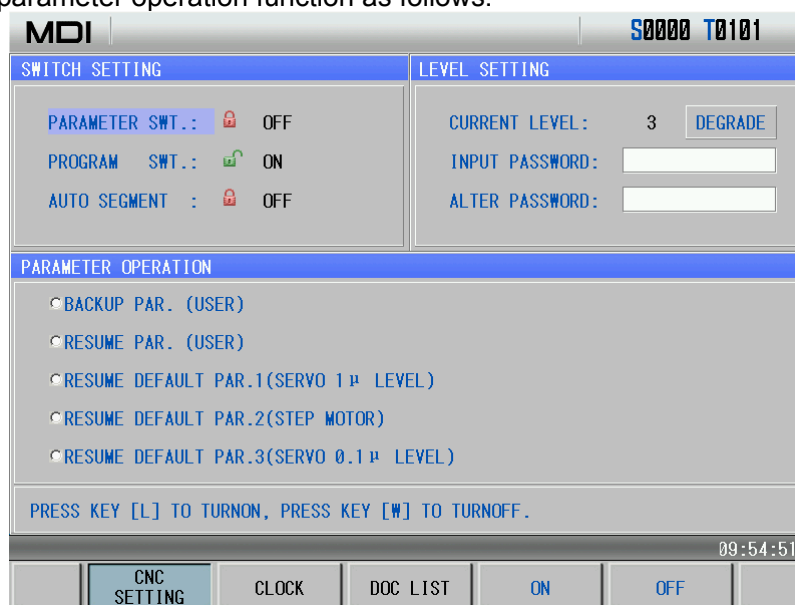

## 10.1.1 Switch setting

When the cursor is in the switch set column, the system can set parameters, programs, automatic sequence number ON/OFF state.

## 1) Switch explanation:

Parameter switch: parameters can be modified when the parameter switch is ON; they are forbidden to alter when it is OFF.

Program switch: programs can be edited when the program switch is ON; they are forbidden to edit when it is OFF.

Automatic block number: the block number is automatically generated when the automatic sequence number switch is ON and a program is edited; when the switch is OFF, the block number is input manually instead of being automatically generated.

## 2) Switch setting method:

a) Move the cursor to the setting item;

b) Press **ON** (or **L**) to open the switch, press **OFF** (or **W**) to close it;

**Note:** When the parameter switch is shifted from “OFF” to “ON”, an alarm will be issued by CNC system. The

alarm can be cancelled by pressing **RESET**. If the PARM SWT is shifted again, no alarm is issued. For security it should set the PARM SWT for “OFF” after the parameter alteration is finished.

## 10.1.2 Level setting

To prevent programs, CNC parameters from being modified at will, GSK980TDc provides the level setting function, and its password grade is divided into five, from high to low grade: 2<sup>nd</sup> grade (machine manufacturer), 3<sup>rd</sup> grade (device management), 4<sup>th</sup> grade (engineer), 5<sup>th</sup> grade (machining

operation), 6<sup>th</sup> grade(operation limit). The current operation grade is displayed in “Current Level: \_” in the level setting page.

2<sup>nd</sup> grade: it is for the machine manufacturer, which permits the machine manufacturer to alter the state parameters, data parameters, pitch compensation data, tool compensation data, to edit programs, to transmit PLC and so on.

3<sup>rd</sup> grade: it permits to alter state parameters, data parameters, tool compensation data and to edit programs.

4<sup>th</sup> grade: it permits to alter tool compensation data (toolsetting operation), macro variables, to edit programs, but not to alter state parameters, data parameters and pitch compensation data.

5<sup>th</sup> grade: it permits to alter tool compensation data, not to select and edit programs, and not to alter state programs, data programs and pitch compensation data.

6<sup>th</sup> grade: it has no level to operate only the machine operation panel, not to alter tool compensation data, not select and edit programs, not to alter state parameters, data parameter and pitch compensation data.

**1) Operation grade entry**

- a) Move the cursor to the line “INPUT PASSWORD” in the CNC setting page;
- b) Input the operation password(the system displays one “\*” as soon as a number is input);
- c) Press  and the operator can enter the corresponding grade operation;
- d) After the operator enters the corresponding operation grade page, the prompt column prompts the system’s current grade, and the corresponding operations as follows:

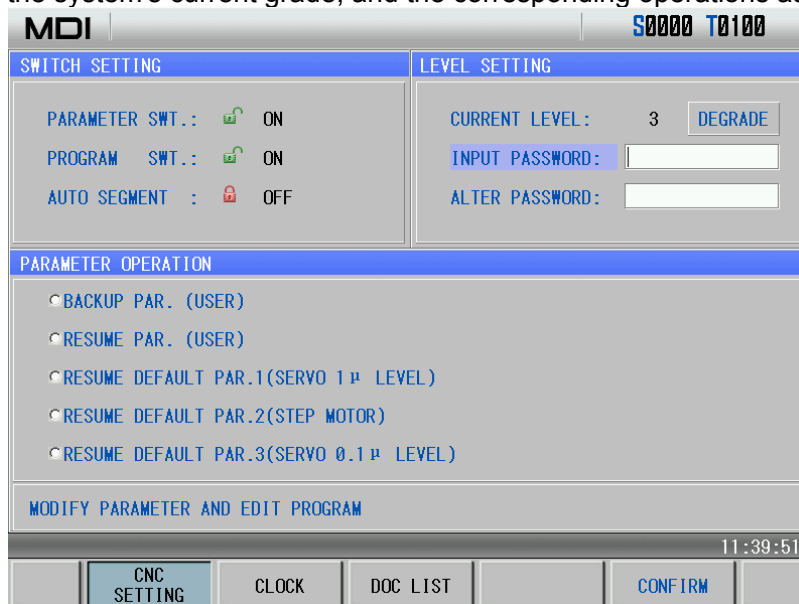

**Note 1:** The defined password length corresponds to the operation grade, and the user cannot increase or reduce the length at will, which is shown below:

Operation grade	Length	Initial password
3 <sup>rd</sup> grade	5 digits	12345
4 <sup>th</sup> grade	4 digits	1234
5 <sup>th</sup> grade	3 digits	123
6 <sup>th</sup> grade	None	None



**Note 2:** When the operation level is less than or equal to the 3<sup>rd</sup> grade ( 3<sup>rd</sup>, 4<sup>th</sup>, 5<sup>th</sup> or 6<sup>th</sup> grade) and the system is turned on again, the operation level does not change. When the level is the 2<sup>nd</sup> grade and the system is turned on again, the operation level defaults to the 3<sup>rd</sup> grade.

**2) Password modification**

Steps:

- a) The operator enters the grade to alter the password according to the method “Operation grade entry” after the system enters the setting page;
- b) Move the cursor to the line “ALATER PASSWORD”;



- c) Input the new password, and then press  ;
- d) The CNC prompts “ Input the new password again”;
- e) Input the new password again and then press  . When the two input passwords are identical, the CNC prompts “Password has been altered, please save the new password.” The password alteration is done successfully.

**Note:** The system prompts “ The new password is not identical with the confirmation” when the two input passwords are not identical. At the moment, input the new password again.



**3) Operation grade degradation**

The degradation is to degrade from the high to the low, and its steps are shown below:

- a) Input the password according the method of “Operation grade entry” after the system enters the setting page;

- b) Move the cursor to the line “CURRENT LEVEL” and the system pops up  as follows:



- c) Press  (or  ), and the CNC prompts “Password degrades one grade” as follows:

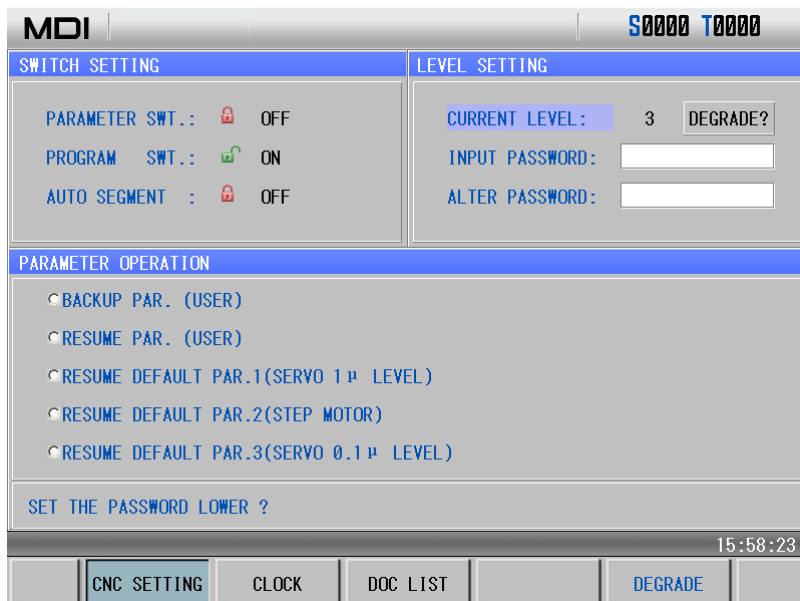

d) Press **DEGRADE** (or **DATA INPUT**) again, and the degradation is done successfully as follows:



**Note 1:** The degradation operation cannot be executed when the current level is the 6<sup>th</sup> grade.

**Note 2:** The current password can be altered after degradation. When the system is in the high level, the degradation can be executed to set to the low-level password.

### 10.1.3 Parameter operation

The parameter data (state parameter, data parameter) can be backup (stored) and recovered (read). Programs can be stored in the CNC when the backup or recovery is executed. The display is shown below:

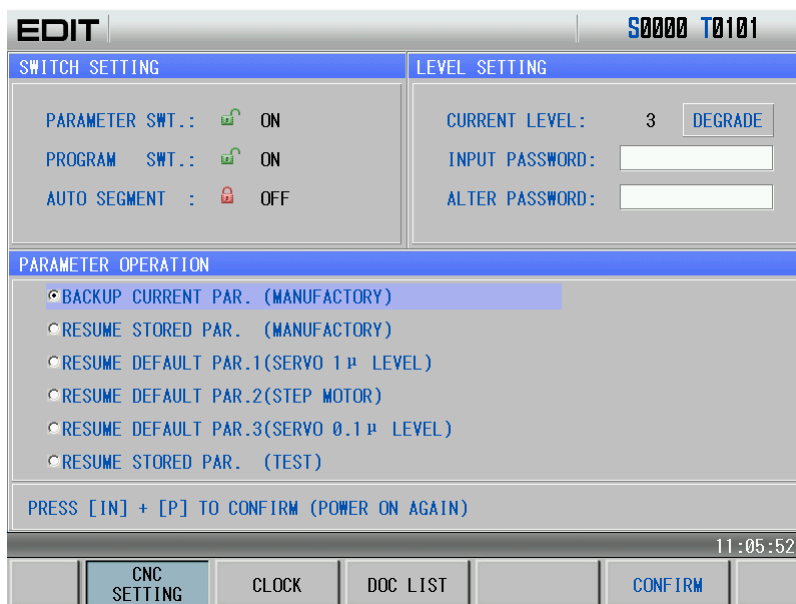

**1) Option explanation:**

Backup current parameters (user): the user to backup the CNC data (store)

Resume backup parameters(user): the user resumes the backup data (read)

Resume parameter 1(servo 1u level): the user reads the original parameter data matched

with the servo drive with the precision 1um

Resume parameter 2(stepper 1u level): the user reads the original parameter data matched with the stepper drive



Resume parameter 3(servo 0.1u level): the user reads the original parameter data matched with the servo drive with the precision 0.1um



**Note:** When the level is the 2<sup>nd</sup> grade, the backuping current parameters (user ) and resuming backup parameters (user) become backuping current parameters (machine manufacturer) and resuming backup parameters (machine manufacturer), which is used to backup and resume the manufacturer's data.

**2) Operation methods:**

a) Open the parameter switch;



b) Press  to enter the MDI mode, move the cursor the required item;

c) Press  (or simultaneously press  ,  ), and the system prompts whether to confirm the current operation.





d) Press  again (or  ), and the system prompts the backup or resume is done successfully. When the recovery is done, the system prompts power-on again.

**Note:** Don't turn off the system and execute other operations when the backup or resuming is executed.

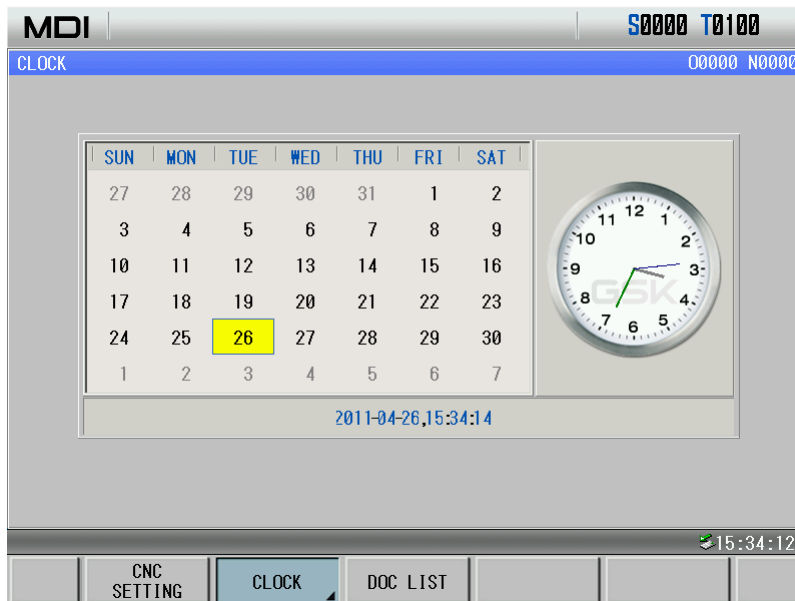
**10.2 Clock Setting**

Press  and then  to enter the system clock page. The operator can alter the current data and time as follows:



Press  to enter the alteration mode, press  ,  to move the cursor to the required modification (Year/Month/Date/Minute/Second), input directly numbers, and press  , then  to escape from the alteration mode.

### 10.3 Graphic Display



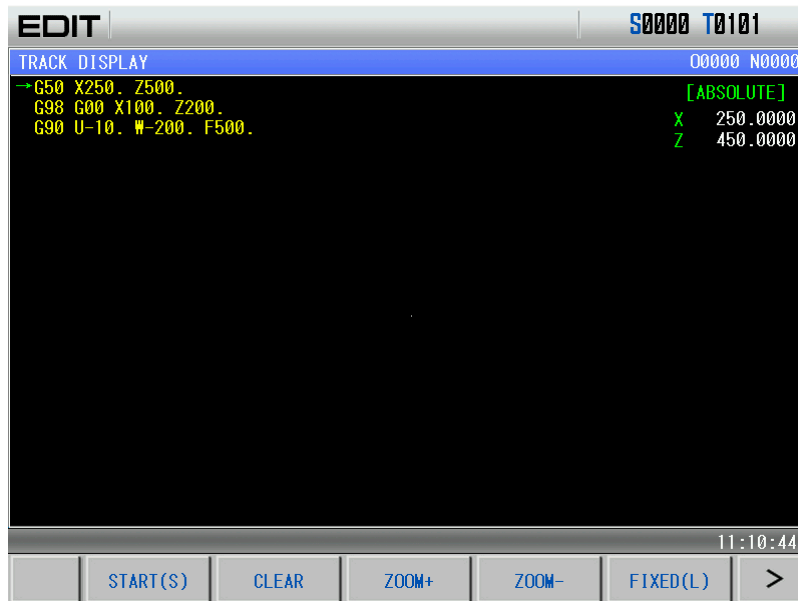

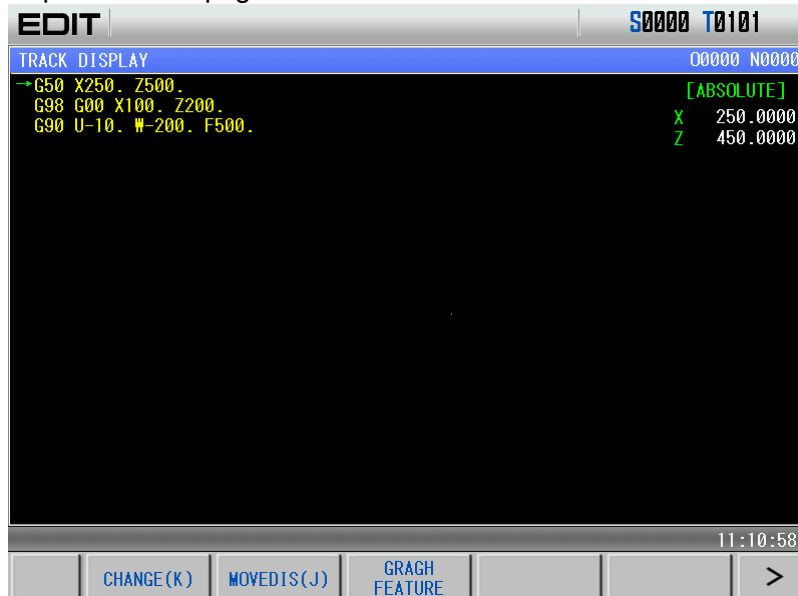

Press  key to enter the path page as follows:





Press  to open the next page menu as follows:



#### 1) The START, STOP and CLEAR of the graphic path

In the path display page, press the  (or ) and the system starts the drawing; press  (or ) , it stops drawing; press  (or ) , it clears the current graphic path.

When the path exceeds the display range during automatic graph, the system regulate the graphic center following the tool nose position in real time. Press  (or ) and the display area is locked, the system does not regulate the graphic center on when the path

exceeds the display area. Press **FLOAT(L)** (or **L**) and the system releases the lock.

**2) Scaling up and down**

In the path display page, press **ZOOM+** (or **I**), **ZOOM-** (or **M**), the system scales up/down the path in real time. Press **ZOOM+** (or **I**) each time, the graphic path is scaled up  $\sqrt{2}$  fold, press **ZOOM-** (or **M**) each time, the graphic path is scaled down  $\sqrt{2}$  fold.

**3) Path display moving**

In the graph display page, press the cursor movement key to move the graphic path. Press **SWITCHING** (or **J**) to adjust mobile intervals.

**4) Graphic attribution display**

In the path display page, press **GRAGH FEATURE** (or **G**) to display the graphic attribution window, including the current coordinate system, translation position, scaling and mobile interval. It is shown below:

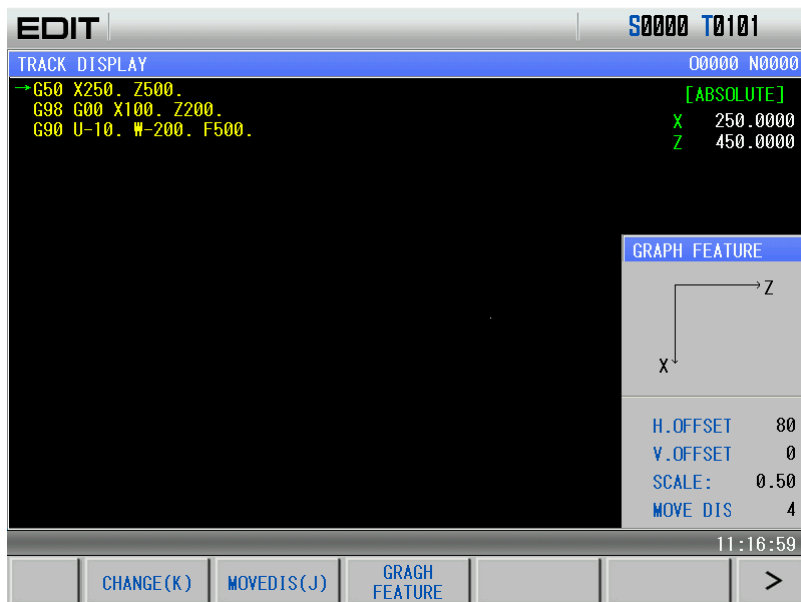

Press **GRAGH FEATURE** (or **G**) again to close the graph attribution window.

**5) Graphic parameter meaning**

Coordinate system setting: 8 types of graphic paths can be displayed in this GSK980TDc CNC system according to the front or rear tool post coordinate system, and there is 4 kinds of path as follows: (switch X, Z axis by pressing **SWITCHING** or **K**)

<b>Bit parameter No.175</b>		<b>Graphic path coordinate display</b>
<b>Bit1</b>	<b>Bit0</b>	

Bit parameter No.175		Graphic path coordinate display
Bit1	Bit0	
0	0	
0	1	
1	0	

Bit parameter No.175		Graphic path coordinate display
Bit1	Bit0	
1	1	

### 10.4 Parameter Setting

Parameter setting can adjust related characteristics of the drive unit and machine.

Press **PROGRAM** to enter Parameter interface which includes **BIT PARA.**, **DATA PARA.**, **OFTEN USED**, **PITCH COMP** as follows:

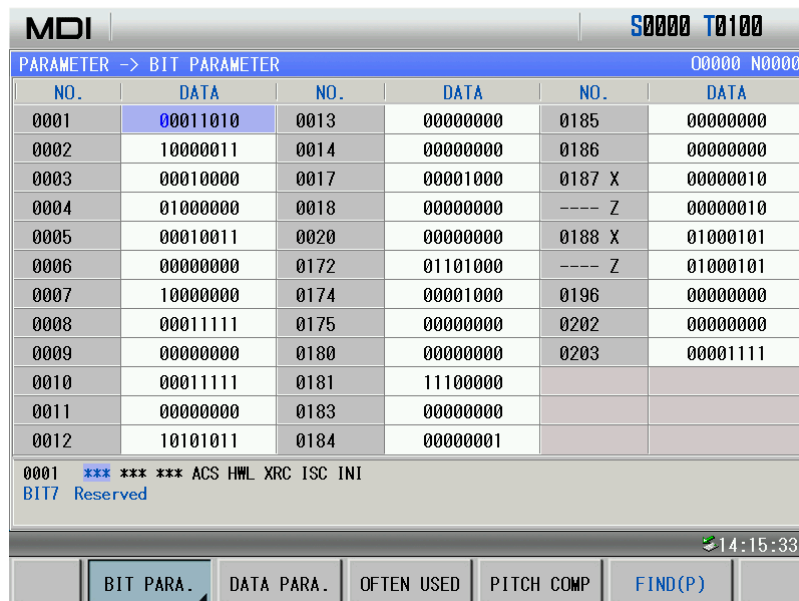

MDI						S0000 T0100
PARAMETER -> BIT PARAMETER						00000 N0000
NO.	DATA	NO.	DATA	NO.	DATA	
0001	00011010	0013	00000000	0185	00000000	
0002	10000011	0014	00000000	0186	00000000	
0003	00010000	0017	00001000	0187 X	00000010	
0004	01000000	0018	00000000	---- Z	00000010	
0005	00010011	0020	00000000	0188 X	01000101	
0006	00000000	0172	01101000	---- Z	01000101	
0007	10000000	0174	00001000	0196	00000000	
0008	00011111	0175	00000000	0202	00000000	
0009	00000000	0180	00000000	0203	00001111	
0010	00011111	0181	11100000			
0011	00000000	0183	00000000			
0012	10101011	0184	00000001			



0001 \*\*\* \*\* ACS HML XRC ISC INI  
BIT7 Reserved



14:15:33

BIT PARA. DATA PARA. OFTEN USED PITCH COMP FIND(P)

#### 10.4.1 State parameter

- 1) Byte alteration:
  - a) Turn on the parameter switch;
  - b) Enter the MDI mode;
  - c) Move the cursor to the parameter number to be set:

Method 1: Press  or to enter the page containing the parameter to be set, press  or  key to move the cursor to the parameter number to be set;

Method 2: Press  (or ), and input the parameter number in the pop-up dialogue box, at last, press .

- 4) Key in a new parameter value;
- 5) Press  key, the parameter value is entered and displayed.
- 6) For security, the PARM SWT needs to be set to OFF after all parameter settings are finished.

Example:

Set the bit parameter No.001 Bit 3(STEP/MPG) to 1, and the other bits remain unchanged. Move the cursor to No.001, input 00011000 by sequence according to the above steps. The display is shown below:

MDI		S0000 T0101			
PARAMETER -> BIT PARAMETER					00000 N0000
NO.	DATA	NO.	DATA	NO.	DATA
0001	00011010	0013	00000000	0185	00000000
0002	10000010	0014	00011111	0186	00000000
0003	00010000	0017	00001000	0187 X	00000010
0004	01000000	0018	00000000	---- Z	00000010
0005	00010011	0020	00000000	---- A	00000000
0006	00000000	0172	00101000	---- B	00000000
0007	10000000	0174	00001000	---- C	00000011
0008	00011111	0175	00000011	0188 X	01000101
0009	00000000	0180	00000000	---- Z	01000101
0010	00011111	0181	11100000	---- A	01000101
0011	00000000	0183	00000000	---- B	01000101
0012	10101011	0184	00000001	---- C	01000101

0001 \*\*\* \*\* XRC ISC INI  
BIT2 X axis programming mode in 0:diameter 1:radius

11:36:57

BIT PARA. DATA PARA. OFTEN USED PITCH COMP FIND(P)

Press  to finish the parameter alteration. The page is shown below:



MDI		S0000 T0101			
PARAMETER -> BIT PARAMETER					O0000 N0000
NO.	DATA	NO.	DATA	NO.	DATA
0001	00011010	0013	00000000	0185	00000000
0002	10000010	0014	00011111	0186	00000000
0003	00010000	0017	00001000	0187 X	00000010
0004	01000000	0018	00000000	---- Z	00000010
0005	00010011	0020	00000000	---- A	00000000
0006	00000000	0172	00101000	---- B	00000000
0007	10000000	0174	00001000	---- C	00000011
0008	00011111	0175	00000011	0188 X	01000101
0009	00000000	0180	00000000	---- Z	01000101
0010	00011111	0181	11100000	---- A	01000101
0011	00000000	0183	00000000	---- B	01000101
0012	10101011	0184	00000001	---- C	01000101



0001 \*\*\* \*\* XRC ISC INI  
BIT2 X axis programming mode in 0:diameter 1:radius

11:37:21

BIT PARA. DATA PARA. OFTEN USED PITCH COMP FIND(P)

## 2) Alteration by bit:

- a) Turn on the parameter switch;
- b) Enter the MDI mode;
- c) Move the cursor to the parameter number to be set (the method is referred to Section 10.4.1 Step c) ;

d) Press  to enter the bit alteration mode, at the moment, some bit of the parameter is backlighted. Press  or  to move the cursor to the bit to be altered, then key in 0 or 1;

e) After all parameters setting is finished, the PARM SWT needs to be set to OFF for security.

**Note:** After the system enters some bit of the parameter,  is pressed to escape from the alteration mode, and the cursor stops the parameter number .

Example:

Set the Bit3 of the bit parameter No.001 to 1, and the other bits remains unchanged.

Move the cursor to No.001 according to the above steps, press  to skip to some bit of the parameter, and move the cursor to Bit3. The display is shown below:

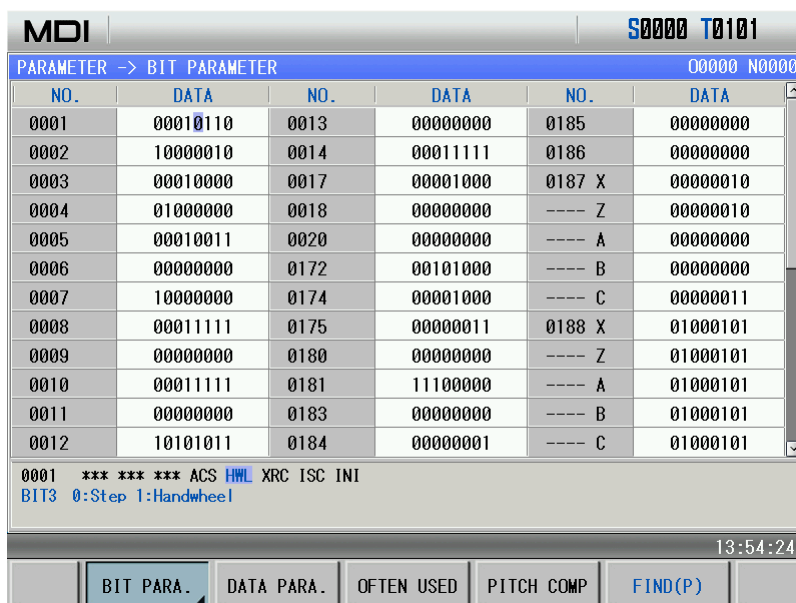

Input 1, and the parameter alteration is done.

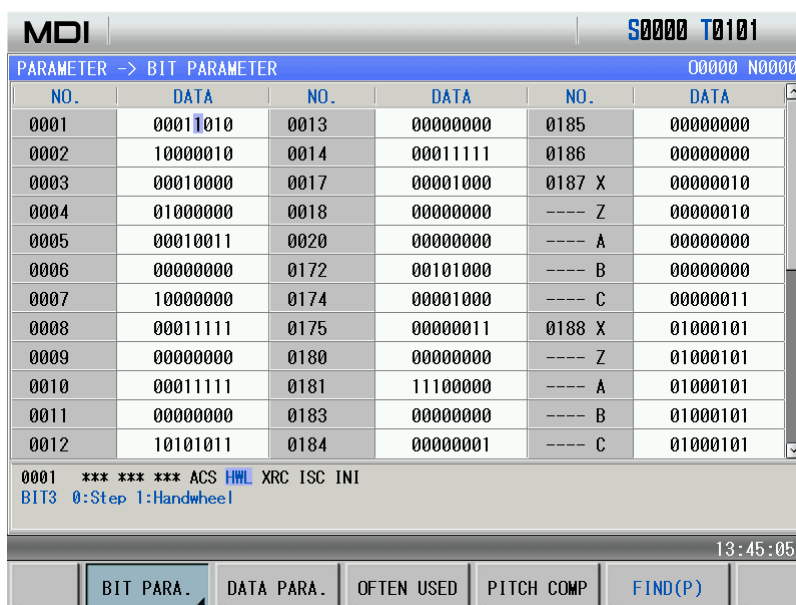

### 10.4.2 Data parameter, pitch compensation

- 1) Turn on the parameter switch;
  - 2) Enter the MDI mode;
  - 3) Move the cursor to the No. of the parameter to be set;
  - 4) Key in the new parameter value;
  - 5) Press  key, the value is entered and displayed;
  - 6) After all parameters setting is finished, the PARM SWT needs to be set to OFF for security.
- Explanation:** The screw-pitch parameter can only be altered under the 2 level password authority.

Example 1: set the data parameter No.027 to 7600.

Move the cursor to No.027 by the steps above, key in 7600 by sequence as follows:

MDI		S0000 T0101			
PARAMETER → DATA PARAMETER				O0000 N0000	
NO.	DATA	NO.	DATA	NO.	DATA
0015 X	1	0021 S2	0	0025	0
---- Z	1	0022 X	4000	0026	100
---- A	1	---- Z	7600	0027	8000
---- B	1	---- A	8000	0028	200
---- C	1	---- B	8000	0029	100
0016 X	1	---- C	180000	0030	200
---- Z	1	0023 X	100	0031	1260
---- A	1	---- Z	100	0032 X	200
---- B	1	---- A	100	---- Z	400
---- C	1	---- B	100	---- A	400
0019	5	---- C	100	---- B	400
0021 S1	0	0024	0	---- C	400
0022 Max.speed of rapid traverse(mm/min)					
13:55:03					
BIT PARA.		DATA PARA.		OFTEN USED	
				PITCH COMP	
				FIND(P)	

Press  to finish the alteration. The display is shown below:

MDI		S0000 T0101			
PARAMETER → DATA PARAMETER				O0000 N0000	
NO.	DATA	NO.	DATA	NO.	DATA
0015 X	1	0021 S2	0	0025	0
---- Z	1	0022 X	4000	0026	100
---- A	1	---- Z	7600	0027	8000
---- B	1	---- A	8000	0028	200
---- C	1	---- B	8000	0029	100
0016 X	1	---- C	180000	0030	200
---- Z	1	0023 X	100	0031	1260
---- A	1	---- Z	100	0032 X	200
---- B	1	---- A	100	---- Z	400
---- C	1	---- B	100	---- A	400
0019	5	---- C	100	---- B	400
0021 S1	0	0024	0	---- C	400
0022 Max.speed of rapid traverse(mm/min)					
13:55:33					
BIT PARA.		DATA PARA.		OFTEN USED	
				PITCH COMP	
				FIND(P)	

Example 2: set X value of the screw-pitch parameter No.000 to 12.

Move the cursor to screw-pitch parameter No.000 by the steps above, key in 12 in order as follows:

MDI		S0000 T0101									
PARAMETER -> SCREW-PITCH COMPENSATION										00000 N0000	
AXIS X		AXIS Z		AXIS A		AXIS B		AXIS C			
NO.	VALUE	NO.	VALUE	NO.	VALUE	NO.	VALUE	NO.	VALUE		
0000	12	0200	0	0400	0	0600	0	0800	0		
0001	0	0201	0	0401	0	0601	0	0801	0		
0002	0	0202	0	0402	0	0602	0	0802	0		
0003	0	0203	0	0403	0	0603	0	0803	0		
0004	0	0204	0	0404	0	0604	0	0804	0		
0005	0	0205	0	0405	0	0605	0	0805	0		
0006	0	0206	0	0406	0	0606	0	0806	0		
0007	0	0207	0	0407	0	0607	0	0807	0		
0008	0	0208	0	0408	0	0608	0	0808	0		
0009	0	0209	0	0409	0	0609	0	0809	0		
0010	0	0210	0	0410	0	0610	0	0810	0		
0011	0	0211	0	0411	0	0611	0	0811	0		
0012	0	0212	0	0412	0	0612	0	0812	0		
0013	0	0213	0	0413	0	0613	0	0813	0		

14:06:06

BIT PARA. DATA PARA. OFTEN USED PITCH COMP FIND(P)

Press **DATA INPUT** key to finish the alteration. The display page is shown below:

MDI		S0000 T0101									
PARAMETER -> SCREW-PITCH COMPENSATION										00000 N0000	
AXIS X		AXIS Z		AXIS A		AXIS B		AXIS C			
NO.	VALUE	NO.	VALUE	NO.	VALUE	NO.	VALUE	NO.	VALUE		
0000	12	0200	0	0400	0	0600	0	0800	0		
0001	0	0201	0	0401	0	0601	0	0801	0		
0002	0	0202	0	0402	0	0602	0	0802	0		
0003	0	0203	0	0403	0	0603	0	0803	0		
0004	0	0204	0	0404	0	0604	0	0804	0		
0005	0	0205	0	0405	0	0605	0	0805	0		
0006	0	0206	0	0406	0	0606	0	0806	0		
0007	0	0207	0	0407	0	0607	0	0807	0		
0008	0	0208	0	0408	0	0608	0	0808	0		
0009	0	0209	0	0409	0	0609	0	0809	0		
0010	0	0210	0	0410	0	0610	0	0810	0		
0011	0	0211	0	0411	0	0611	0	0811	0		
0012	0	0212	0	0412	0	0612	0	0812	0		
0013	0	0213	0	0413	0	0613	0	0813	0		

14:06:06

BIT PARA. DATA PARA. OFTEN USED PITCH COMP FIND(P)

### 10.4.3 Often used parameters

Press **PARAMETER** to enter parameter interface, and press **OFTEN USED** to enter the often used parameter page. The page is shown below:

MDI		S0000 T0100			
PARAMETER -> OFTEN USED PARAMETER				O0000 N0000	
NO.	DATA	NO.	DATA	NO.	DATA
0001	00011010	0016 X	1	0030	200
0004	01000000	---- Z	1	0031	1260
0006	00000000	0021 S1	0	0032 X	200
0007	10000000	---- S2	0	---- Z	400
0008	00011111	0022 X	4000	0033 X	100
0009	00000000	---- Z	8000	---- Z	200
0010	00011111	0023 X	100	0034 X	0
0011	00000000	---- Z	100	---- Z	0
0013	00000000	0026	100	0036 S1	0
0014	00000000	0027	8000	---- S2	0
0015 X	1	0028	200	0037 S1	9999
---- Z	1	0029	100	---- S2	9999

0001 \*\*\* \*\* ACS HWL XRC ISC INI  
BIT7 Reserved

11:42:00

BIT PARA. DATA PARA. OFTEN USED PITCH COMP FIND(P)

The user can add the often used state parameter, data parameters to the often used parameters to get the convenient search and alteration.

1) Adding often used parameters

a) In the state parameter page, press **BIT PARA.** to enter the state parameter menu. The page is shown below:

MDI		S0000 T0101			
PARAMETER -> BIT PARAMETER				O0000 N0000	
NO.	DATA	NO.	DATA	NO.	DATA
0001	00010110	0013	00000000	0185	00000000
0002	10000010	0014	00011111	0186	00000000
0003	00010000	0017	00001000	0187 X	00000010
0004	01000000	0018	00000000	---- Z	00000010
0005	00010011	0020	00000000	---- A	00000000
0006	00000000	0172	00101000	---- B	00000000
0007	10000000	0174	00001000	---- C	00000011
0008	00011111	0175	00000011	0188 X	01000101
0009	00000000	0180	00000000	---- Z	01000101
0010	00011111	0181	11100000	---- A	01000101
0011	00000000	0183	00000000	---- B	01000101
0012	10101011	0184	00000001	---- C	01000101

0001 \*\*\* \*\* ACS HWL XRC ISC INI  
BIT2 X axis programming mode in 0:diameter 1:radius

14:10:10

ADD TO OFTEN USED FIND(P)

b) Move the cursor to the required addition parameter number (taking example of No.003), press **ADD TO OFTEN USED**, and the current parameter becomes the often used. The added is automatically sorted in the last line. The page is shown below:

II Operation

MDI		S0000 T0101			
PARAMETER -> OFTEN USED PARAMETER					O0000 N0000
NO.	DATA	NO.	DATA	NO.	DATA
0188 B	01000101	0225 A	65	0230 C	0
---- C	01000101	---- B	66	0235	0
0196	00000000	---- C	67	0236	4
0202	00000000	0226 X	1	0001	00010110
0203	00001111	---- Z	2		
0216 X	3600000	---- A	3		
---- Z	3600000	---- B	4		
---- A	3600000	---- C	5		
---- B	3600000	0230 X	1		
---- C	3600000	---- Z	3		
0225 X	88	---- A	0		
---- Z	90	---- B	0		

0001 \*\*\* \*\* ACS HML XRC ISC INI  
BIT7 Reserved

14:14:34

BIT PARA. DATA PARA. OFTEN USED PITCH COMP FIND(P)

At the moment, pressing **MOVE UP**, **MOVE DOWN**, **AUTO ORDER** can adjust the parameter sorting position.

**Note:** The addition method of data parameter is similar to that of state parameter.

### 2) Sorting often used parameters

Pressing **MOVE UP**, **MOVE DOWN** can move the parameter where the current cursor is. Pressing **AUTO ORDER** sorts all often used parameter in sequence number.

### 3) Removing often used parameters

Move the cursor to the required parameter in the often used parameter page. Press **REMOVE FROM OFTEN USED** and the current often used parameter is removed. Press **REMOVE ALL** and all often used parameters are removed.

### 4) Altering often used parameter

Parameters can be altered directly in the often used parameter page. Its alteration method is the same that of state parameter and data parameter. Its value is also refreshed in the state parameter or data parameter page.

## CHAPTER 11 U OPERATION FUNCTION



### 11.1 File Management Function Introduction

GSK980TDc has the file management function to execute the file copy, data backup, data resume, the system upgrading (2<sup>nd</sup> grade) and so on.

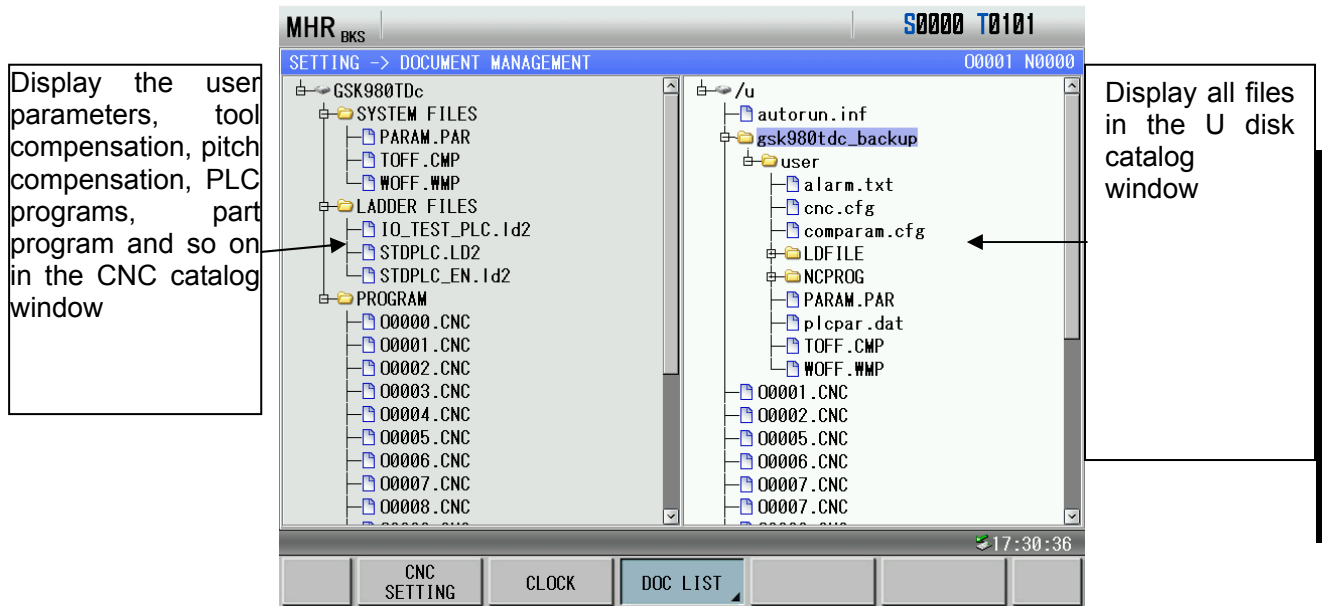
In any states, press **SETTING** to select the setting interface, press **DOC LIST** to enter the file management page. Insert U disk and the system automatically identifies it. The system displays the icon  at the lower right bottom of the system after it successfully identifies the icon as follows:



II Operation

Press the soft key **SWITCHING** (or **CHANGE**) to select the CNC catalog or the U disk catalog, and press ,  to move the line where the current cursor is.

### 11.2 Often Used File Operation Function Introduction

#### 11.2.1 File extension and return

- 1) Move the cursor to the required extension file, press  to extend it as follows:

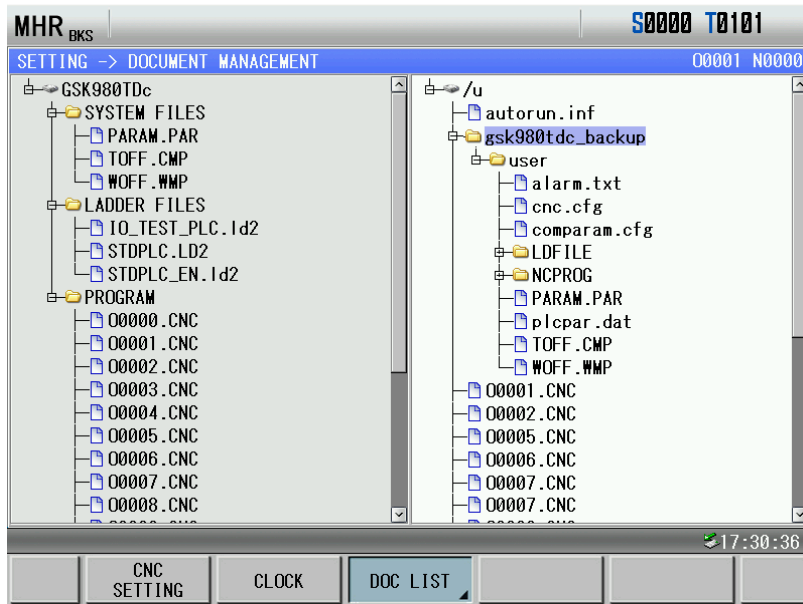

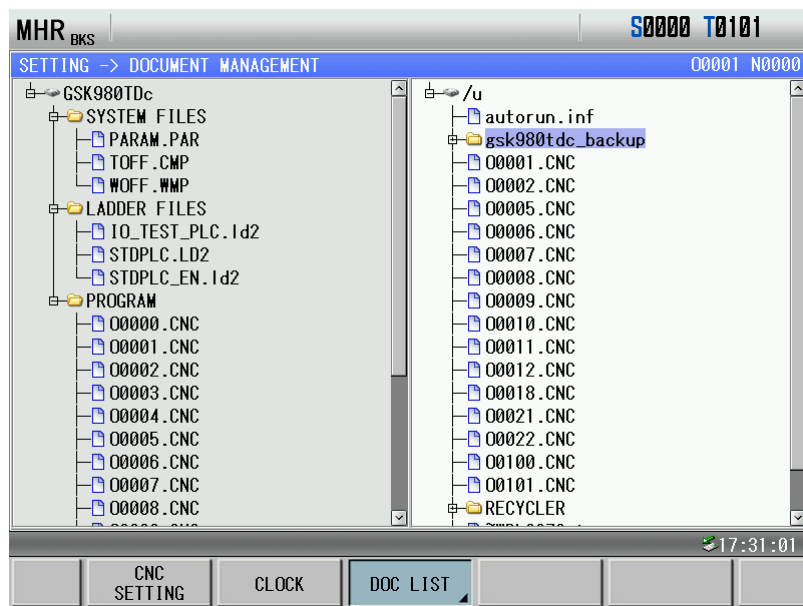

2) Move the cursor to the target file, press  to return the previous catalog of the current file as follow:



### 11.2.2 File selection and cancellation of file selection

Take an example of U:\gsk980tdc\_backup\user\NCPROG\00010.CNC to introduce the selection and cancellation.

- 1) Press  to select setting interface, press  to enter the file management page as follows:



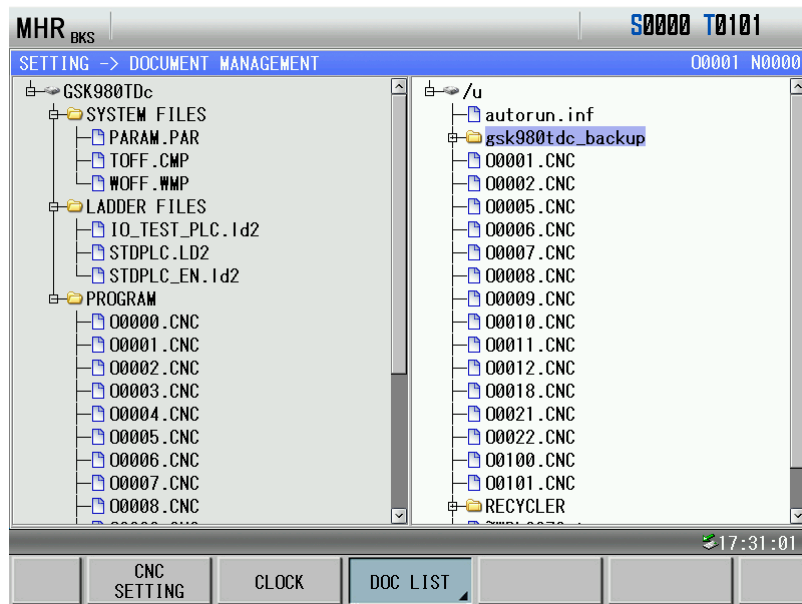

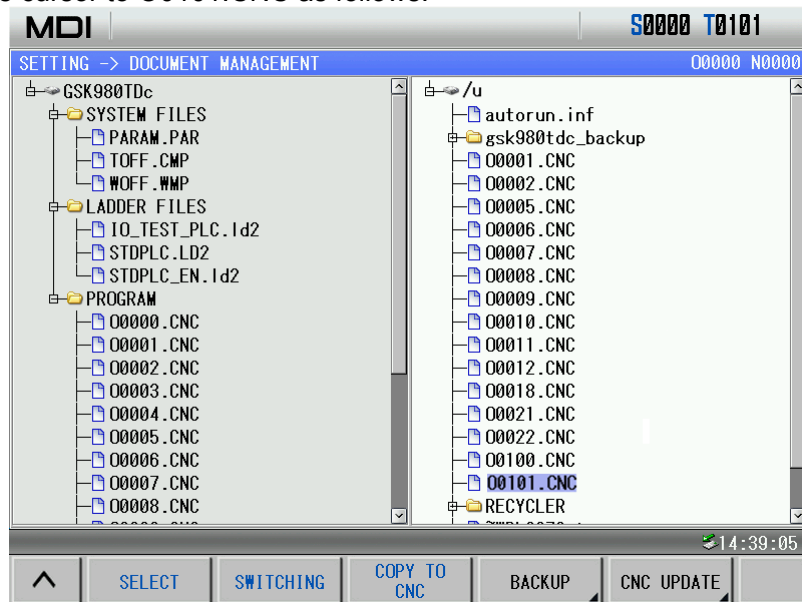

2) Move the cursor to O0101.CNC as follows:



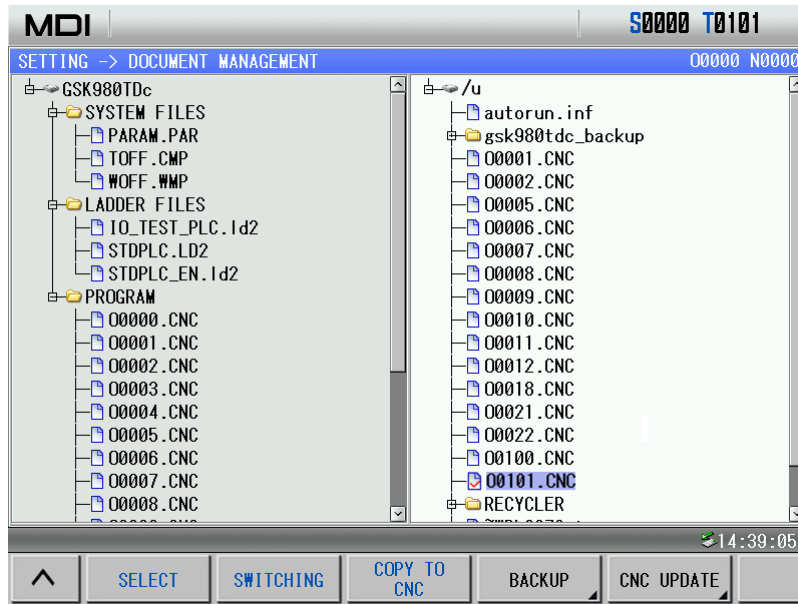

3) Press **SELECT** (or **DATA INPUT**) to select O0101.CNC as follows:



4) Press  (or  again ) to cancel the selection of O0101.CNC.

### 11.2.3 File copy

Refer to Section 11.2.2 to select the file. When the cursor is in the U disk catalog window,  is pressed and the files in the U disk is copied to the CNC; when the cursor is in the CNC catalog window,  is pressed and the file in the CNC is copied to the U disk.

## 11.3 Data Copy and Resume

In the file management page, backup, resume the CNC data (including the system parameters, part parameter, tool compensation, pitch compensation, ladder parameters, ladder, alarm log and so on) via the U disk.

### 11.3.1 Entering backup/restore page

After the system identifies the U disk, it enters the file management page. Press  to enter the backup/restore page as follows:

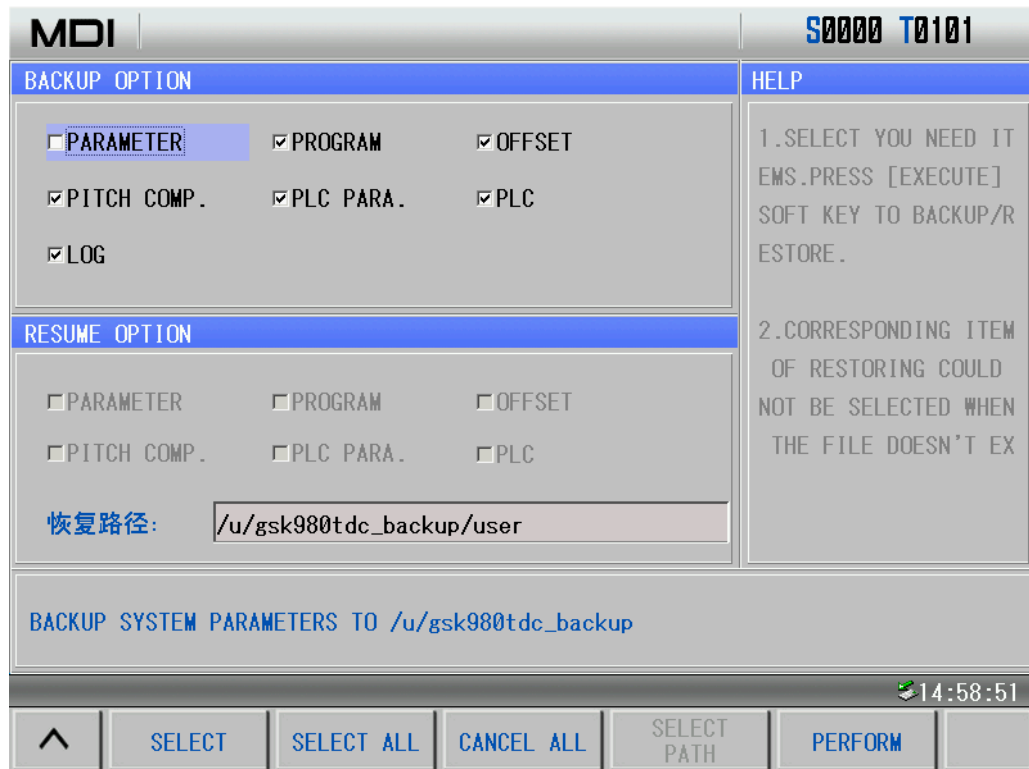

### 11.3.2 Backup/resume operation

- 1) Press , , , to move the cursor to the required option;
- 2) Press (or ) to select the required option to be backup/resumed;
- 3) Press (or ) to cancel the selection when the cursor has been in the selected option;
- 4) Press or to select or cancel all selection;
- 5) Press (or ) to execute the current selected.

**Note 1:** Data which has been backup or has been done to store in the U disk can be resumed.

**Note 2:** When the cursor is in the “BACKUP OPTION” column, all options in the the “RESUME OPTION” column cannot be selected; when the cursor is in the “RESUME OPTOIN”, all options in the “BACKUP OPTION” column cannot be selected;

**Note 3:** Pressing executes operations only in the column where the cursor is. When the cursor is in “BACKUP OPTION” column, the resume operation is executed. The backup, resume cannot be executed simultaneously.

### 11.3.3 Operation path selection

When the user uses the U disk to execute the CNC data backup, the CNC creates a backup file “gsk980tdc\_backup” in the root catalog of the U disk. The backup file includes two backup data “U:\gsk980tdc\_backup\user” and “U:\gsk980tdc\_backup\serial number” (it is created by the system’s serial number). When the user uses one U disk to execute data backup of many CNC systems, the data in “U:\gsk980tdc\_backup\user” is replaced by the new but data in “U:\gsk980tdc\_backup\serial

number” remains unchanged.

For the above reason, the user should execute the operation path selection during resuming data:

Default path : U:\gsk980tdc\_backup\user



Serial number path: U:\gsk980tdc\_backup\serial number

Example: backup/resume data of many CNC systems

When the user backups the system A (serial number CT0000001), the generated file by data backup is “U:\gsk980tdc\_backup\CT0000001” and “U:\gsk980tdc\_backup\user”; When the user backups the system B (serial number CT0000002), the generated file by data backup is “U:\gsk980tdc\_backup\CT0000002”. The “U:\gsk980tdc\_backup\user” generated by A is replaced automatically by the same name of the system B. At the moment, the user can execute the operation path selection when it executes the data resume operation of the system A:

- 1) When the previous data of the system A is resumed, the operation path is : “U:\gsk980tdc\_backup\CT0000001”;
- 2) When the backup data of the system B is copied to the system A, the operation path is: “U:\gsk980tdc\_backup\CT0000002” or default path;

Press **SELECT PATH** and appear the dialog box of operation path selection, and then select the

operation path by   when the cursor is in the resume column. Taking an example of selecting the default path, the display is shown below:

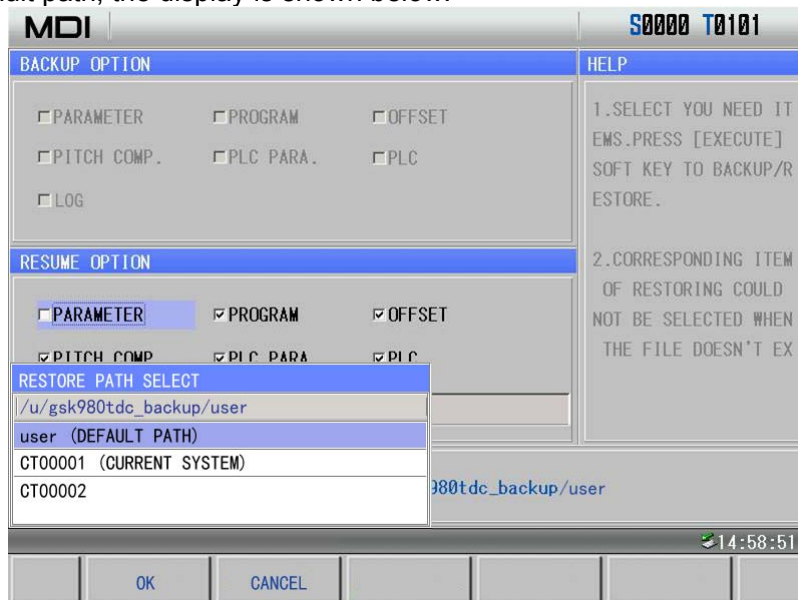

### 11.3.4 Format of data backup/resume file

	File	Extension name	Content
Parameter file	PARAM	.PAR	State parameters, data parameters
Tool compensation data	TOFF	.CMP	Tool offset, tool wear
Pitch compensation	WOFF	.WMP	Pitch compensation

Alarm log	Alarm.his	.his	Alarm log
PLC program	No requirements	.ld2	PLC programs
PLC parameter	plcpar	.dat	K, D, DT, DC parameters
Part program	O0000~O9999	.CNC	Part programs

### 11.3.5 Level explanation of data backup/resume operation

Backup operation	System parameters	More than the 5 <sup>th</sup> grade password
	Tool compensation data	More than 5 <sup>th</sup> grade(including the 5 <sup>th</sup> grade) password
	Pitch compensation	More than 5 <sup>th</sup> grade(including the 5 <sup>th</sup> grade) password
	Alarm log	More than 5 <sup>th</sup> grade(including the 5 <sup>th</sup> grade) password
	PLC programs	More than 5 <sup>th</sup> grade(including the 5 <sup>th</sup> grade) password
	PLC programs	More than 5 <sup>th</sup> grade(including the 5 <sup>th</sup> grade) password
	Part programs	More than 5 <sup>th</sup> grade(including the 5 <sup>th</sup> grade) password
Resume operation	System parameters	More than 3 <sup>rd</sup> grade(including the 3 <sup>rd</sup> grade) password
	Tool compensation data	More than 5 <sup>th</sup> grade(including the 5 <sup>th</sup> grade) password
	Pitch compensation	More than 2 <sup>nd</sup> grade(including the 2 <sup>nd</sup> grade) password
	PLC programs	More than 5 <sup>th</sup> grade(including the 5 <sup>th</sup> grade) password
	PLC parameters	More than 2 <sup>nd</sup> grade(including the 2 <sup>nd</sup> grade) password
	Part programs	More than 4 <sup>th</sup> grade(including the 4 <sup>th</sup> grade) password

## 11.4 Notes

The user should pay more attention to the followings during executing the data backup/resume operation:

- 1) Need more than the 2<sup>nd</sup> grade password(including the 2<sup>nd</sup> grade) to resume more than (including be equal to) 9000 part programs;
- 2) Backup/resume operation must be in MDI mode;
- 3) When the user executes the data backup operation, the system automatically replaces all files in "U:\gsk980tdc\_backup\user", the user should save them as when they cannot be replaced;
- 4) Stop part programs running before data backup/resume;
- 5) They must not stop unless the data backup/resume operation is completed;
- 6) The system is turned on again after the data resume is done.

## CHAPTER 12 COMMUNICATION

### 12.1 GSK980TDc Communication Software GSKComm

GSKComm is an allocated project administrator. It can execute the upload/download between PC and CNC, conveniently transmit batch with easy operation, high communication efficiency and reliability.

The followings introduce communication transmission and setting between GSK980TDc and GSKComm. Refer to GSKComm explanations about GSKComm communication software functions.

#### 12.1.1 GSKComm's system (PC) requirements

Hardware: general PC with RS232 serial port, serial communication cable (3-wire)

Operation system: Microsoft Windows 98/2000/XP/2003

#### 12.1.2 Software interface

Interface after GSKComm's initial run:

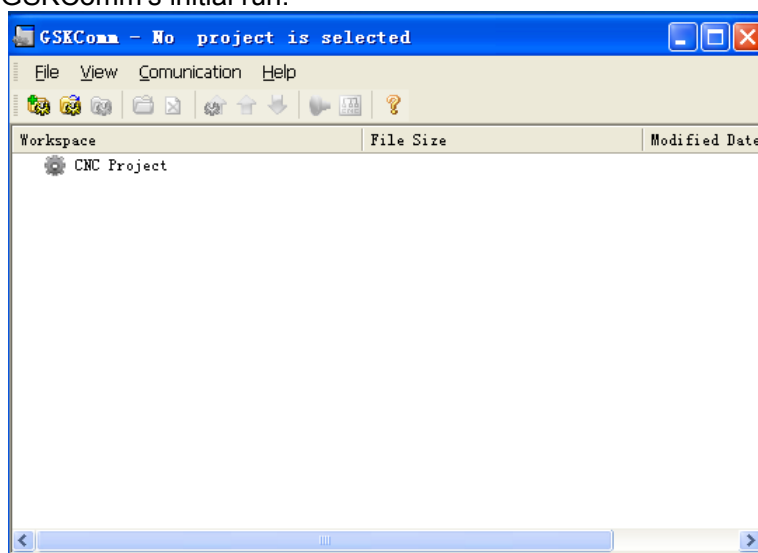
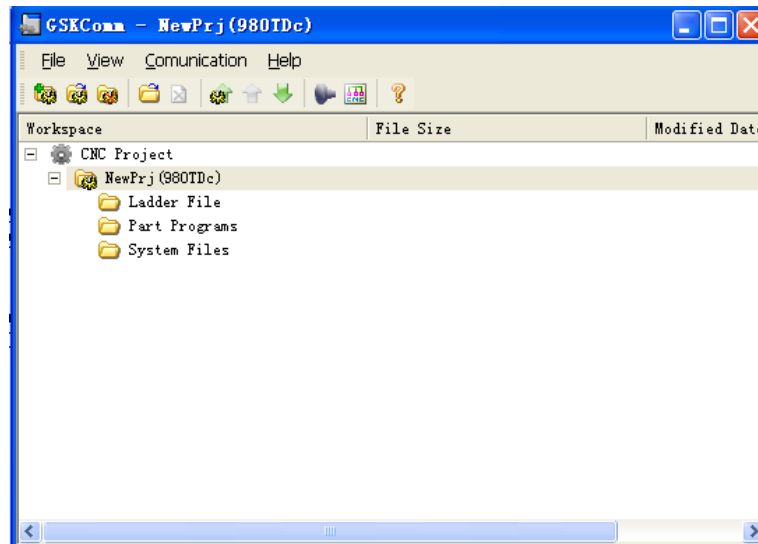

Fig. 12-1 file download (PC→CNC) interface

GSKComm software takes an administrator as a unit to complete management. When it run firstly, it does not upload project files, at the moment, the user should create an project program or upload project to execute the communication operation. The display is shown below after the an project is created:



At the mode, the user can receive the files from the CNC to the current project or send files in the current project to the CNC.

### 12.1.3 Receiving files (CNC→PC)

Click the option [Receive files from CNC] in [Communication] and GSKComm can receive files from the CNC after the current project is selected as follows:

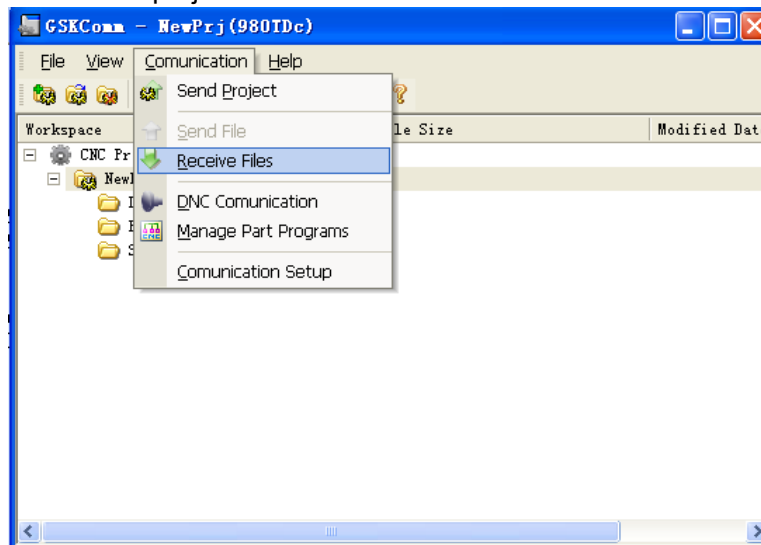

After [Receive Files] is clicked, a dialog box about receiving files from the CNC, the required files from the CNC including part programs, tool compensation (TOFF. CMP), pitch compensation (WOFF.WMP), parameters (PARAM.PAR).

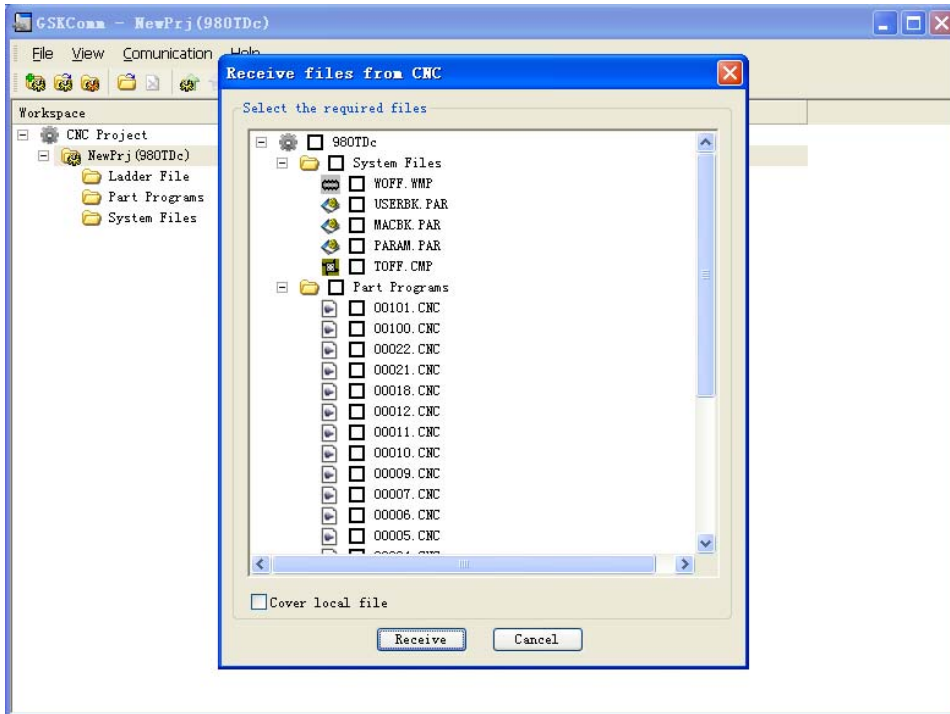

After the user selects the required file, [ Start Receiving ] is pressed and the system pops up a path selection dialog box to save the received files as follows:

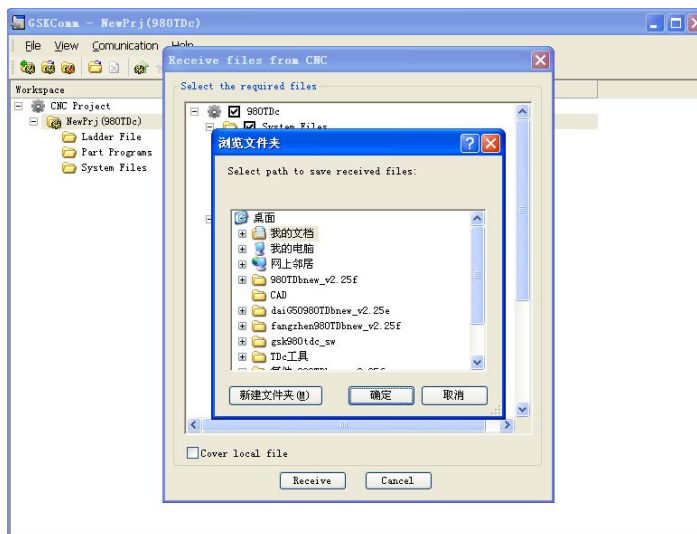

Select the save path, start to receive the file from CNC to PC by pressing [确定, i.e. Confirm] as follows:



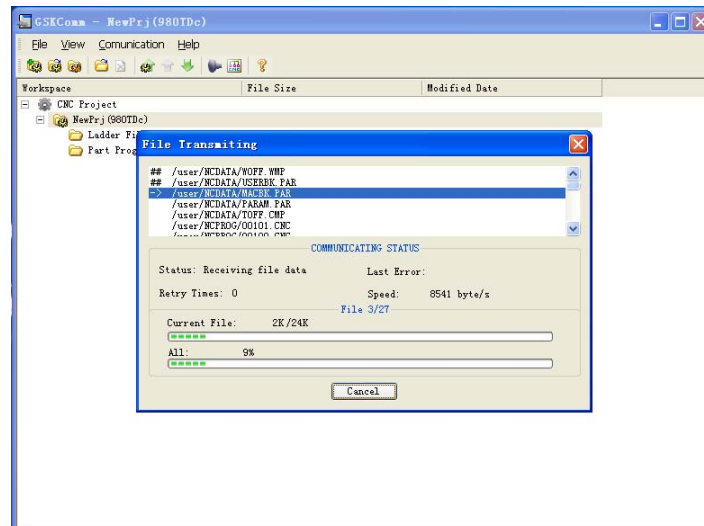

After the receiving is done, the system displays below:

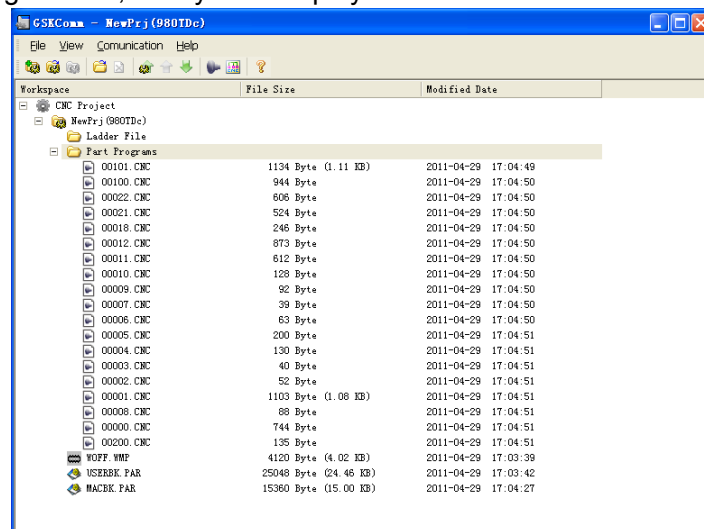

#### 12.1.4 Sending files (CNC→PC)

After the current project file is selected, the user clicks [Send projects to CNC] in the menu [Communication], and so the receiving file from CNC is done. A dialog box to send files to CNC is popped up as follows:

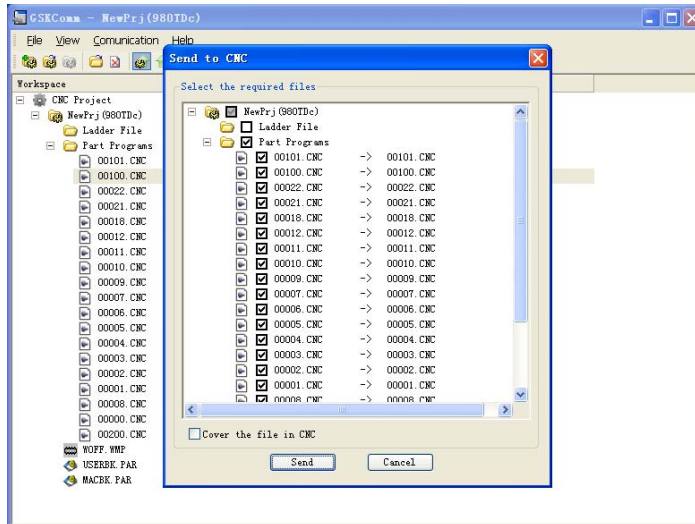

Hereby, the user can select the required receiving files from CNC including part programs, tool compensation (TOFF.CMP), pitch compensation (WOFF.WMP), parameters (PARA.PAR). The part programs which can be altered are saved to the file name of the CNC. Move the cursor to the part program required to alter its program name, double-click the left key to pop up a dialog box as Fig. A, and the file which can be altered is saved the file name of the CNC (as Fig. B).

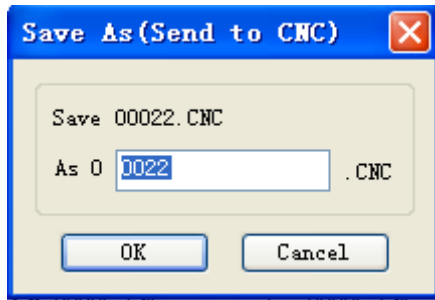

Fig. A

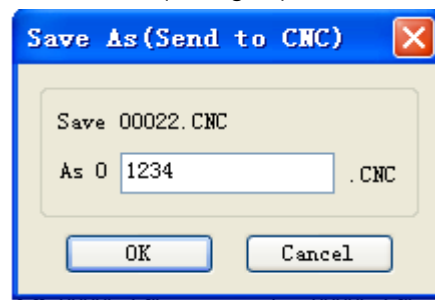
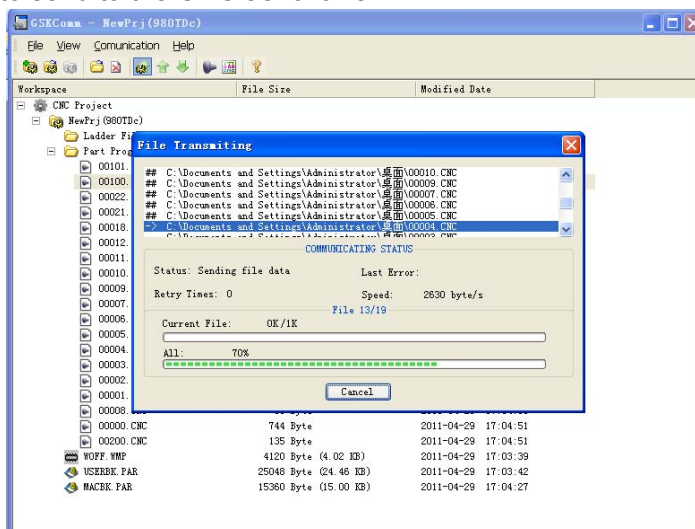
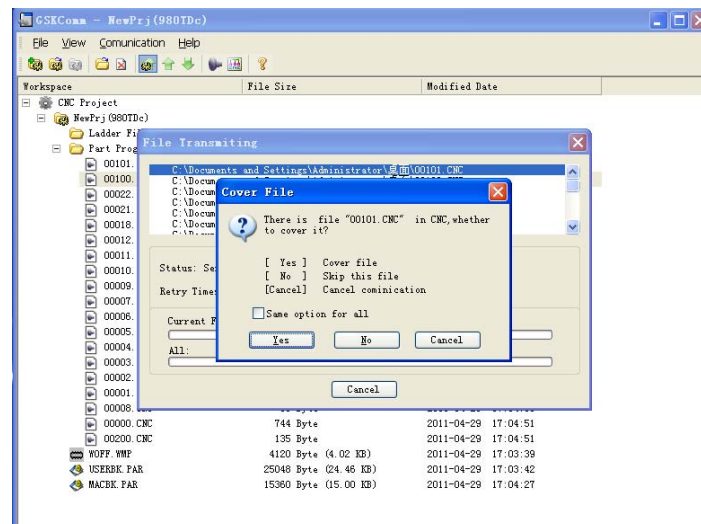

Fig. B

Select the required file to the CNC and confirm the saved file name, then press [start sending], and the file is started to send to the CNC as follows:



When a file name in the CNC is the same that of the transmitting, a dialog box is popped up to select the covering, skipping the file or cancelling transmission as follows:



When the part program name which is has the same that of the transmitted file, the covering cannot be done, otherwise, the system pops up the wrong prompt as follows:

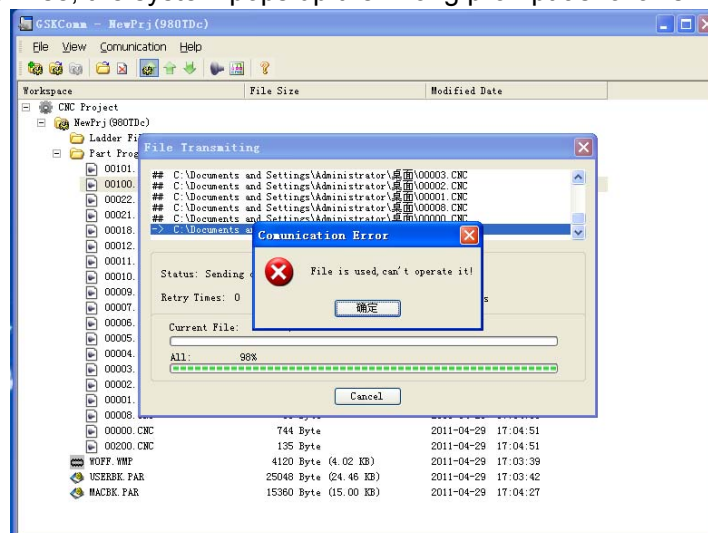

### 12.1.5 Part program management

Select the current project file, then click [Manage Part Programs] in the menu [Communication], and the part programs in the CNC are managed. The system pops up a dialog box to manage part programs in the CNC as follows:

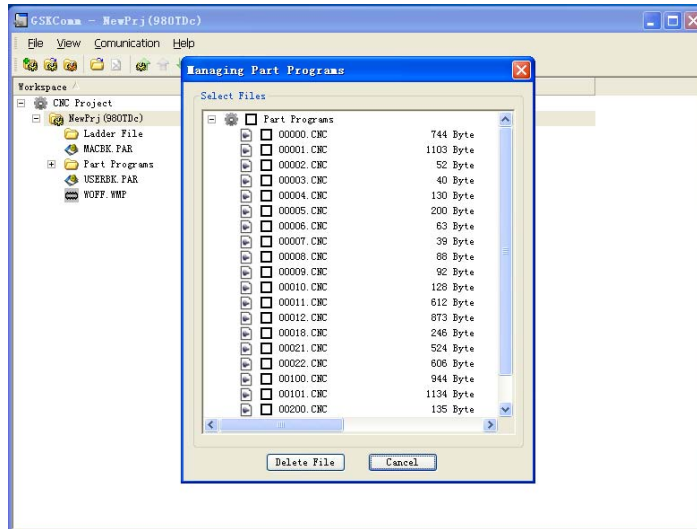

Press [Delete File] and the selected part programs are deleted in the CNC after the required programs are selected.

**Note:** The program being used in the CNC cannot be deleted.

## 12.2 Preparatory before Communication

### 12.2.1 Communication cable connection

DB9 male plug is inserted into CN51 communication interface of the CNC, DB9 female plug is inserted in to DB9-male serial port (COM0 or COM1) of PC. Connect the communication cable when PC and CNC are turned off.

### 12.2.2 Communication setting baud rate

Setting the baud rate of communication ensures that the baud rate of PC is the same that of the CNC communication.

The communication baud of the serial port is set by No.044; click [Communication Setup] in the menu [Communication] and the system pops up a dialog box as follows:



Set the serial port and baud rate. The baud rate should be not less than 4800 when the data is transmitted between CNC and PC, the factory setting is :115200.

**Note 1:** GSK980TDc has no network function, and so it has no network setting in its communication.

**Note 2:** Stop machining when the machining is being done to get the stable communication.

**Note 3:** Must not turn off during the data transmission, otherwise, it causes the mistaken data transmission.

## CHAPTER 13 MACHINING EXAMPLES

Machine a part by a bar stock with dimension  $\Phi 136\text{mm} \times 180\text{ mm}$ , as follows:

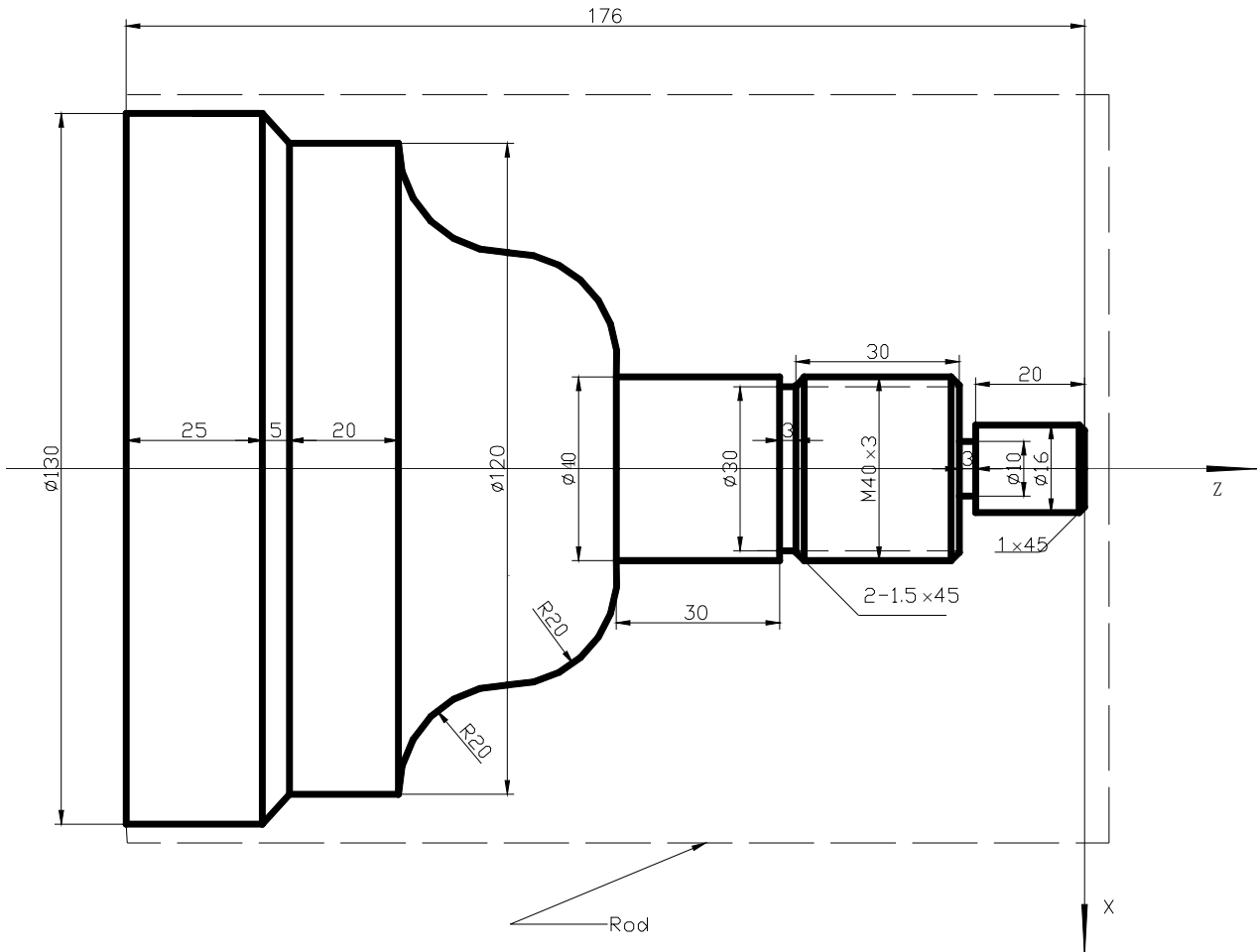

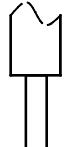



Fig. 13-1

Machine it with 4 tools as follows:

Tool number	Tool shape	Explanation
No. 1		Outer circle rough turning tool
No. 2		Outer circle finish turning tool
No. 3		Grooving tool, tool width 3mm

Tool number	Tool shape	Explanation
No. 4		Threading tool, tool nose angle 60°

### 13.1 Programming

Set up the workpiece coordinate system as Fig.13-1 according to the machining process and the codes introduced in this manual. The programming steps are as follows:

O 0 0 0 1 ;		Name of the part program
N 0 0 0 0	G0 X150 Z50;	Position to the safety height for tool change
N 0 0 0 5	M12;	Clamp the chuck
N 0 0 1 0	M3 S800;	Start the spindle with speed 800
N 0 0 2 0	M8;	Turn on the cooling
N 0 0 3 0	T0101;	Change for the No. 1 tool
N 0 0 4 0	G0 X136 Z2;	Approach the part
N 0 0 5 0	G71 U0.5 R0.5 F200;	Cut depth 2mm and retract 1mm
N 0 0 5 5	G71 P0060 Q0150 U0.25 W0.5;	0.25mm pre-reserved in X axis, 0.5mm machining allowance in Z axis
N 0 0 6 0	G0 X16;	Approach to the end face of the part
N 0 0 7 0	G1 Z-23;	Cut the $\Phi 16$ outer circle
N 0 0 8 0	X39.98;	Cut the end face
N 0 0 9 0	W-33;	Cut the $\Phi 39.98$ outer circle
N 0 1 0 0	X40;	Cut the end face
N 0 1 0 5	W-30;	Cut the $\Phi 40$ outer circle
N 0 1 1 0	G3 X80 W-20 R20;	Cut the convex arc
N 0 1 2 0	G2 X120 W-20 R20;	Cut the concave arc
N 0 1 3 0	G1 W-20;	Cut the $\Phi 120$ outer circle
N 0 1 4 0	G1 X130 W-5;	Cut the cone
N 0 1 5 0	G1 W-25;	Cut the $\Phi 130$ outer circle
N 0 1 6 0	G0 X150 Z185;	Rough cut end and back to the tool change point
N 0 1 7 0	T0202;	Change for the No.2 tool and execute its offset
N 0 1 8 0	G70 P0060 Q0150;	Fine cut cycle

N 0 1 9 0	G0 X150 Z185;	Rough cut end and back to the tool change point
N 0 2 0 0	T0303;	Change for the No.3 tool and execute its offset
N 0 2 1 0	G0 Z-56 X42;	Approach to the part
N 0 2 2 0	G1 X30 F100;	Cut the $\Phi$ 30 groove
N 0 2 3 0	G1 X37 F300;	Return
N 0 2 4 0	G1 X40 W1.5;	Chamfering
N 0 2 5 0	G0 X42 W30;	Keep the width of the grooving
N 0 2 6 0	G1 X40 ;	
N 0 2 6 2	G1 X37 W1.5;	Chamfering
N 0 2 6 4	G1 X10;	Cut the $\Phi$ 10 groove
N 0 2 6 6	G0 X17 Z-1;	
N 0 2 6 8	G1 X16;	
N 0 2 7 0	G1 X14 Z0 F200;	Chamfering
N 0 2 8 0	G0 X150 Z50;	Return to the tool change point
N 0 2 9 0	T0404 S100;	Changing for the No. 4 tool and set the spindle speed for 100
N 0 3 0 0	G0 X42 Z-20;	Approach the part
N 0 3 1 0	G92 X39 W-34 F3;	Thread-cutting cycle
N 0 3 2 0	X38;	Feed 1mm for the 2 <sup>nd</sup> cutting
N 0 3 2 0	X37;	Feed 1mm for the 3rd cutting
N 0 3 3 0	X36.4;	Feed 0.6mm for the 4th cutting
N 0 3 3 2	X36;	Feed 0.4mm for the 5th cutting
N 0 3 4 0	G0 X150 Z50;	Return to the tool change point
N 0 3 5 0	T0100 U0 W0;	Change for the No.1 tool and execute its offset
N 0 3 6 0	M5;	Turn off the spindle
N 0 3 7 0	M9;	Turn off cooling
N 0 3 8 0	M13;	Unclamp the chuck
N 0 3 9 0	M30;	Program ends



## 13.2 Program Input

### 13.2.1 View a saved program

Press **PROGRAM** to enter program interface, and press **LOCAL DIR.** to enter the local catalog page as follows:



In above window the names of the programs saved can be viewed for renaming the new program.

### 13.2.2 Creating a new program

Enter the local catalog page in Edit mode, press address key **O**, choose a name that is not same with the ones in this window (i.e. 0001), key in the number key **0**, **0**, **0**, **1** and **DATA INPUT** to create a new program as follows:

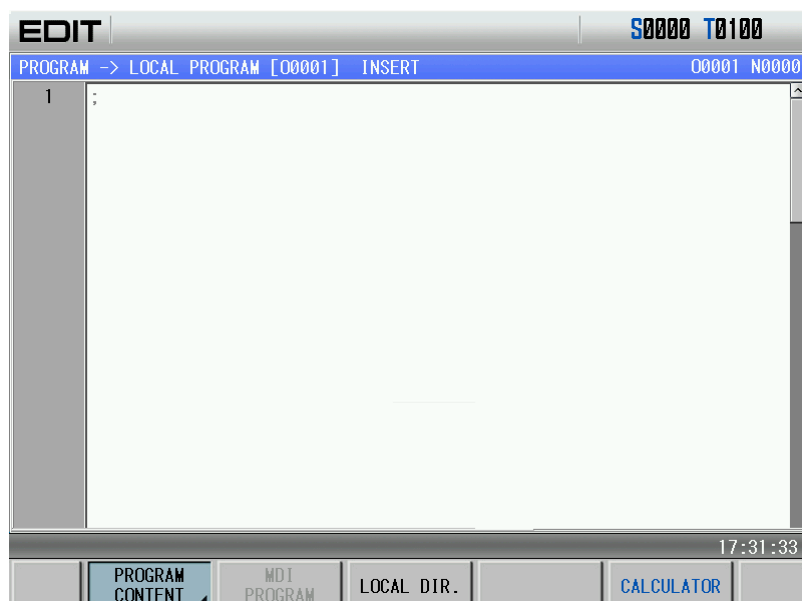

Input the characters of the above edit program one by one and the editing program is done.







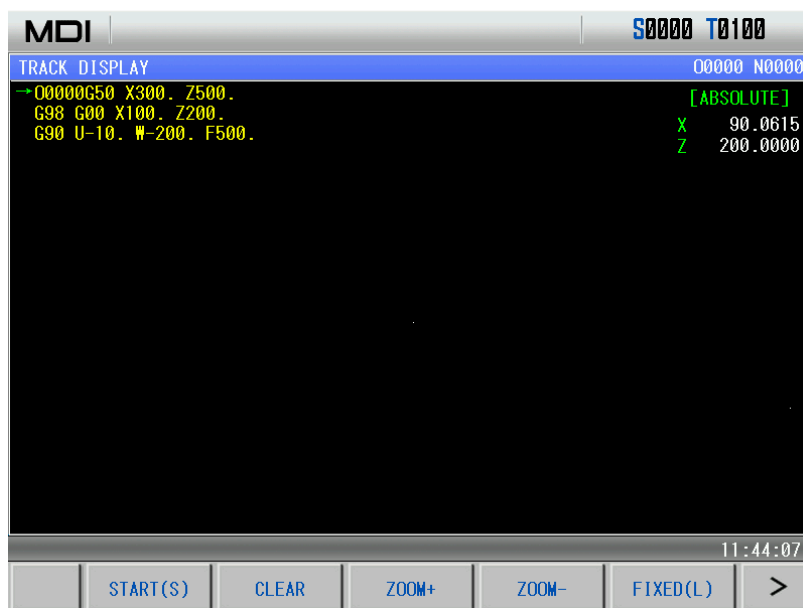



### 13.3 Checkout a Program

#### 13.3.1 Graphic setting

Press  to enter graph interface as follows:



#### 13.3.2 Program check

Press  to enter graph display page. Press  to enter Auto mode, press , ,  to make the auxiliary function lock indicator , machine lock indicator , and dry run indicator  to enter the corresponding state. Press  to start the drawing, press  to automatically run programs, check the program accuracy by displaying the tool motion path, and the display page is the following after the run is completed:

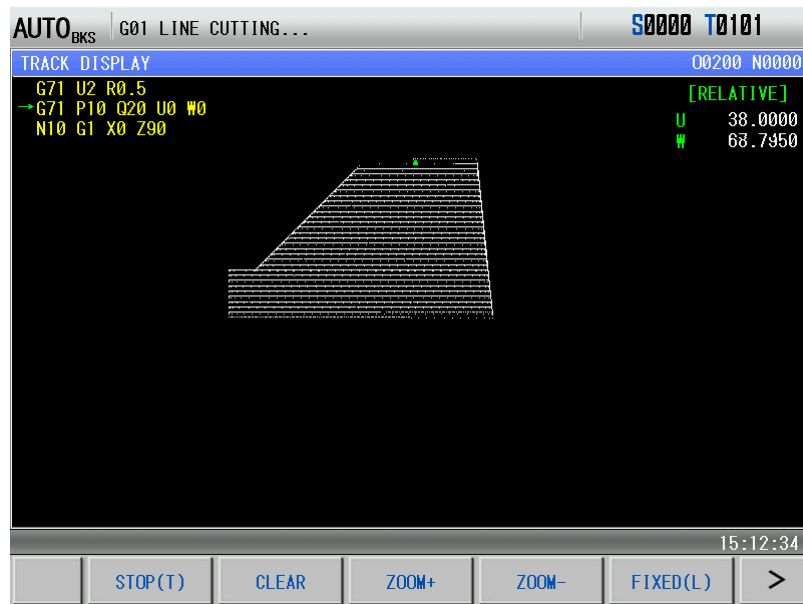

When there is error in the program path, analyze the error and alter the part program, make another checkout for the program by the method above till the error is eliminated..

### 13.4 Toolsetting and Running

- 1) Move the tool to a safe position, execute T0100 U0 W0 command in PROGRAM->MDI page in MDI mode, and cancel the tool offset;
- 2) Move the tool to cut in the part end surface;

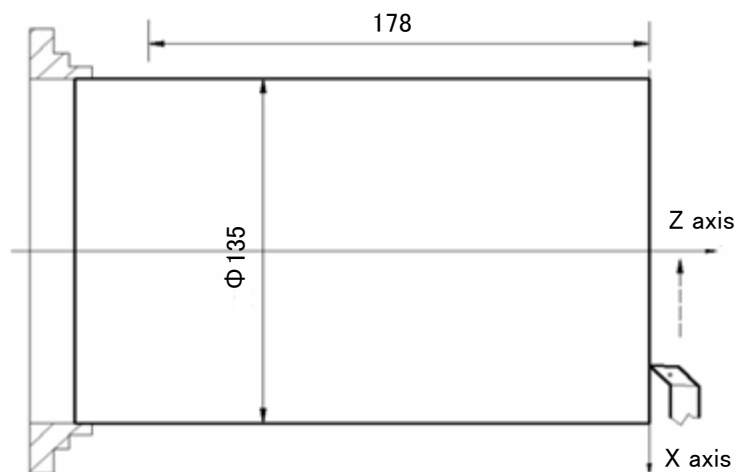

- 3) Release the tool along X when Z does not move, and stop the spindle, execute G50 Z0 in PROGRAM->MDI page in MDI mode to set the coordinate of Z axis;
- 4) Switch to tool offset page and input Z0 to No.001 offset;
- 5) Move the tool and make it to cut along the outer circle of the part;

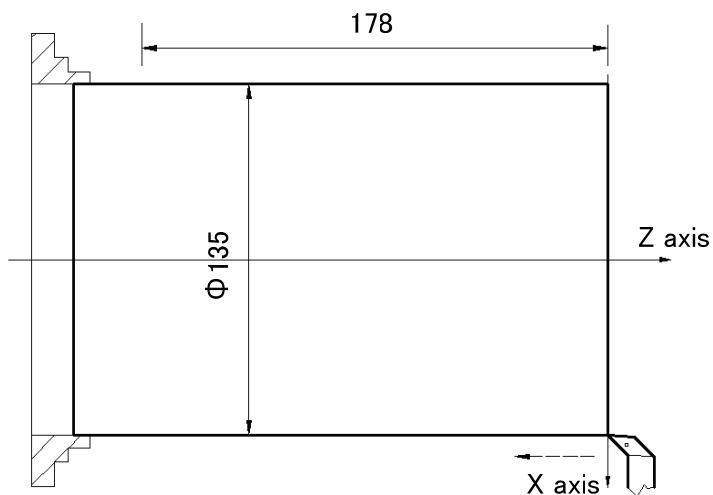

- 6) Release the tool along Z when X does not move, and stop the spindle, measure the dimensions of the outer circle of the part (e.g. The measuring value is 135mm);
- 7) Execute G50 X135 command in PROGRAM>MDI page in MDI mode to set the coordinate of X axis;
- 8) Switch to tool offset page, and input X135 to No.001 offset;
- 9) Move the tool to a safe position, and change No. 002 tool;
- 10) Start the spindle and move the tool to the toolsetting point, as A point in the following figure;

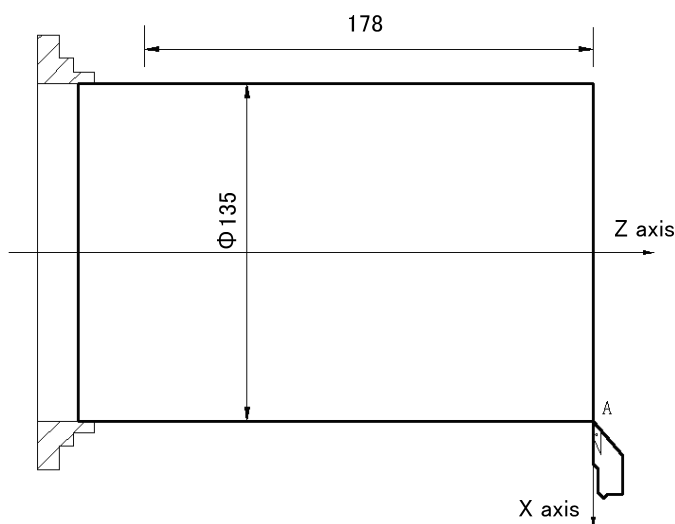

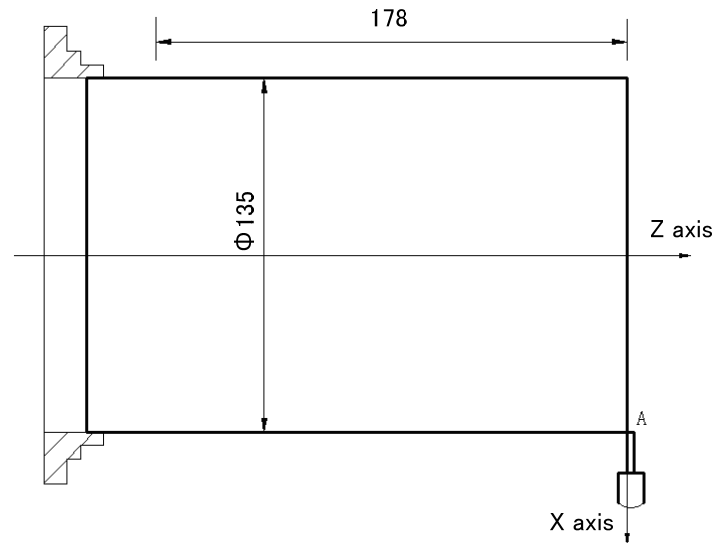

- 11) Switch to TOOL OFFSET window, move the cursor to No.002 offset and input X135 Z0;
- 12) Move the tool to a safe position, and change the No. 003 tool ;
- 13) Start the spindle and move the tool to the toolsetting point, as A point in the following figure;

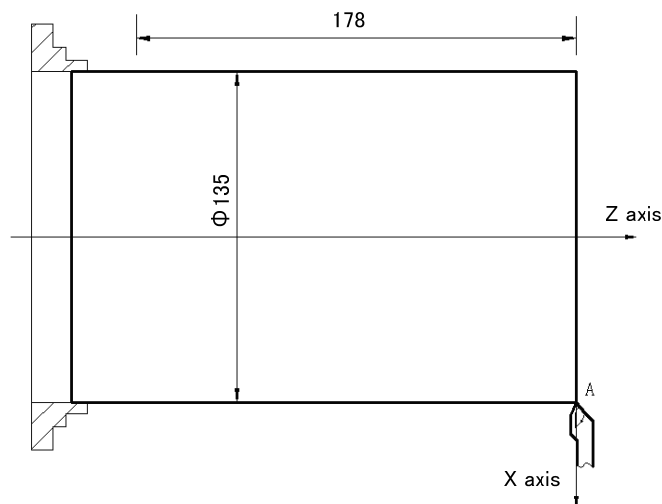

- 14) Switch to TOOL OFFSET window, move the cursor to No.003 offset and input X135 Z0;
- 15) Move the tool to a safe position, and to change the No. 004 tool;
- 16) Move the tool to the toolsetting point, as point A in the following figure;



- 17) Switch to tool offset, move the cursor to No.004 offset and input X135 Z0;
- 18) Move the tool to a safe position after the toolsetting is finished;
- 19) Start the machining in Auto mode;
- 20) If there is any error between the designed and the actual dimensions, the tool offset may be altered till the part dimensions are within the tolerance.

**Note:** Press  key to make the auto running to pause if dwell is needed during the machining. Also if emergency occurs, the user presses the  key, Emergency stop button to cut off the power to terminate the program running.



# III Connection

---





# CHAPTER 1 INSTALLATION LAYOUT

## 1.1 GK980Tdc System Connection

### 1.1.1 GK980Tdc, GSK980Tdc-V rear cover interface layout

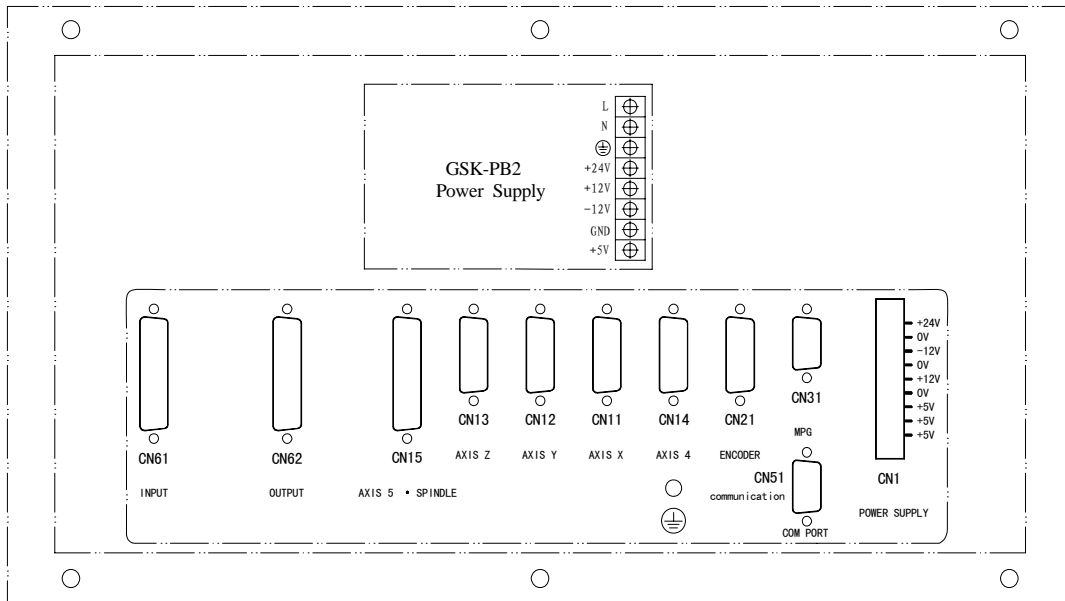

Fig. 1-1 GSK980Tdc rear cover interface layout

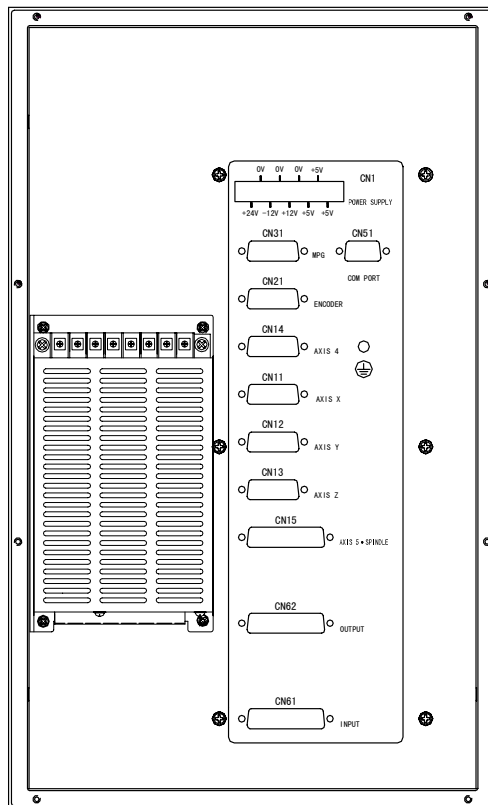

Fig.1-2 GSK 980Tdc-V rear cover interface layout

### 1.1.2 Interface explanation

- Power box: GSK-PB2, for +5V, +24V, +12V, -12V, GND power supply
- Filter(optional): Input terminals for 220V AC power, PE terminal for grounding, output terminals to L, N terminals of GSK-PB2 power box
- CN1: power supply interface
- CN11: X axis, pin15 D female, connect with X drive unit
- CN12: Y axis, pin15 D female, connect with Y drive unit
- CN13: Z axis, pin15 D female, connect with Z drive unit
- CN14: 4th axis, pin15 D female, connect with 4th drive unit
- CN15: spindle, pin 25 D female, connect with spindle drive unit
- CN21: encoder, pin15 D male, connect with spindle encoder
- CN31: MPG, pin26 D male, connect with MPG
- CN51: communication, pin9 D female, connect PC RS232 interface
- CN61: input, pin44 D male, connect with machine input
- CN62: output, pin44 D female, connect with machine output

## 1.2 GSK980TDc Installation

### 1.2.1 GSK980TDc external dimensions

See appendix I , II.

### 1.2.2 Preconditions of the cabinet installation

- The dust, cooling liquid and organic resolution should be effectively prevented from entering the cabinet;
- The designed distance between the CNC back cover and the cabinet should be not less than 20cm, the inside and outside temperature difference of the cabinet should be not more than 10°C when the cabinet inside temperature rises;
- Fans can be fixed in the cabinet to ventilate it;
- The panel should be installed in a place where the cooling can't splash;
- The external electrical interference should be taken into consideration in cabinet design to prevent it from interfering the CNC system.

### 1.2.3 Measures against interference

In order to insure the CNC stable working, the anti-interference technology such as space electromagnetic radiation shielding, impact current absorbing, power mixed wave filtering are employed in CNC design. And the following measures are necessary during CNC connection:

1. Make CNC far from the interference devices (inverter, AC contactor, static generator, high-voltage generator and powered sectional devices etc.);
2. To supply the CNC via an isolation transformer, the machine with the CNC system should be grounded, the CNC and drive unit should be connected with independent grounding wires at the grounding point;
3. To inhibit interference: connect parallel RC circuit at both ends of AC winding (Fig. 1-3a), RC circuit should approach to inductive loading as close as possible; reversely connect parallel freewheeling diode at both ends of DC winding (Fig. 1-3b); connect parallel surge absorber at the ends of AC motor winding (Fig. 1-3c);

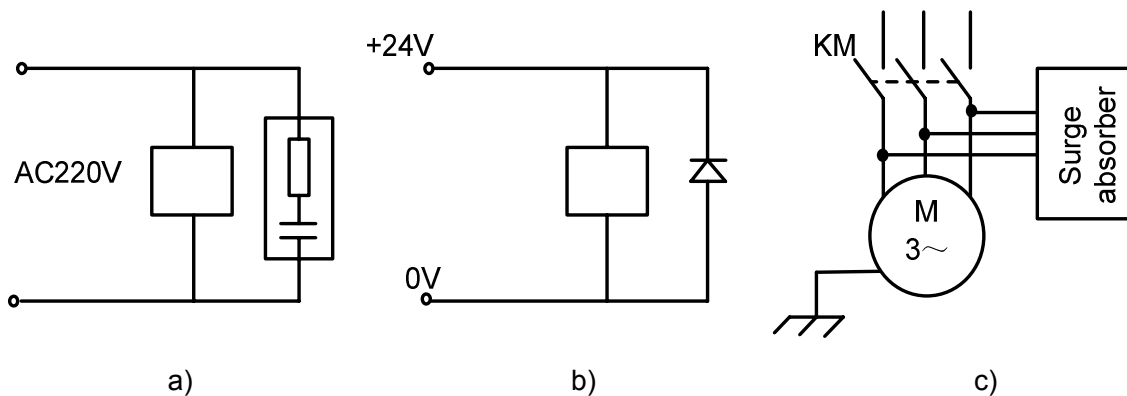

Fig. 1-3

4. The CNC leadout cables use the twisted shield cable or shield cable, the cable shield tier is grounded by an terminal at CNC side, signal cable should be as short as possible;
5. To reduce the mutual interference among the CNC signal cables, and among the strong current, the wiring should follow the following:

Table 1-1 The Wiring requirement

Group	Cable type	Wiring requirement
A	AC power cable	Tie up A group cables with a clearance at least 10cm from that of B, C groups, or shield A group cables from electromagnetism
	AC coil	
	AC contactor	
B	DC coil(24VDC)	Tie up B and A group cables separately or shield B group cables; and the further B group cables are from that of C group, the better it is
	DC relay(24VDC)	
	Cables between CNC and strong-power cabinet	
	Cables between CNC and machine	
C	Cables between CNC and servo drive unit	Tie up C and A group cables separately, or shield C group cables; and the cable distance between C group and B group is at least 10cm and they are twisted pair cables.
	Position feedback cable	
	Position encoder cable	
	Handwheel (MPG) cable	
	Other cables for shield	

## CHAPTER 2 DEFINITION & CONNECTION OF INTERFACE SIGNALS

### 2.1 Connection to Drive Unit

#### 2.1.1 Drive interface definition

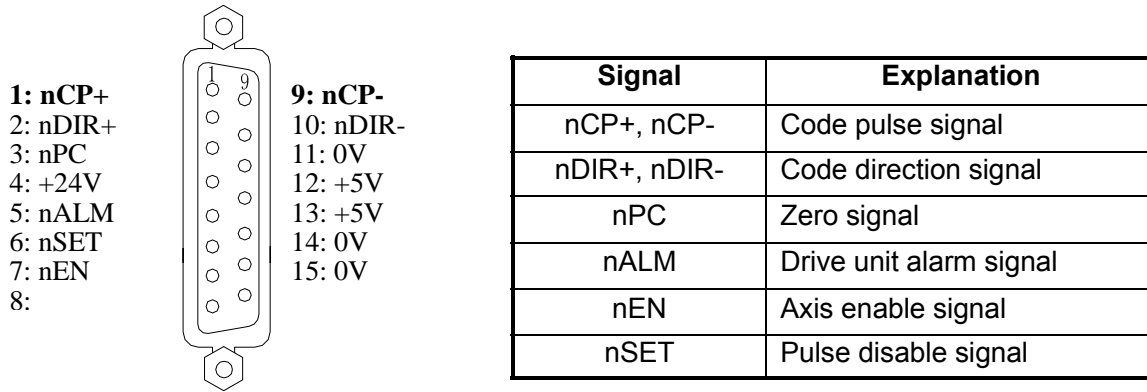

Fig.2-1 CN11, CN12, CN13, CN14 interface (15-core D type female socket)

#### 2.1.2 Code pulse and direction signals

nCP+, nCP- are code pulse signals, nDIR+, nDIR- are code direction signals. These two group signals are both differential output (AM26LS31), it is suggested to receive by AM26LS32 externally, and the interior circuit for them is shown in Fig. 2-2:

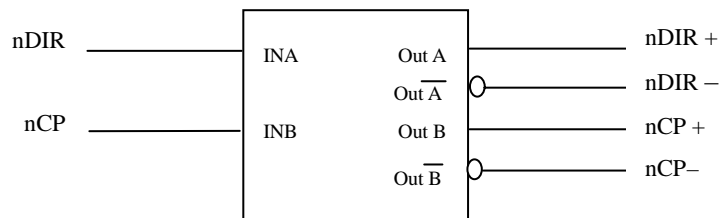

Fig. 2-2 Interior circuit of code pulse and direction signals

#### 2.1.3 Drive unit alarm signal nALM

The low or high level of the drive unit alarm is set by the CNC parameter No.009 Bit0, Bit1, Bit2, Bit3 and Bit4, its interior circuit is shown in Fig. 2-3:

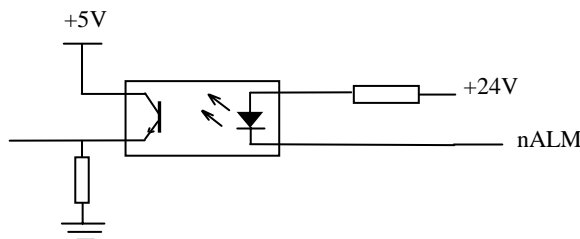

Fig. 2-3 Interior circuit of drive unit alarm signal

This type of input circuit requires that the drive unit transmits signal by the types in Fig. 2-4:

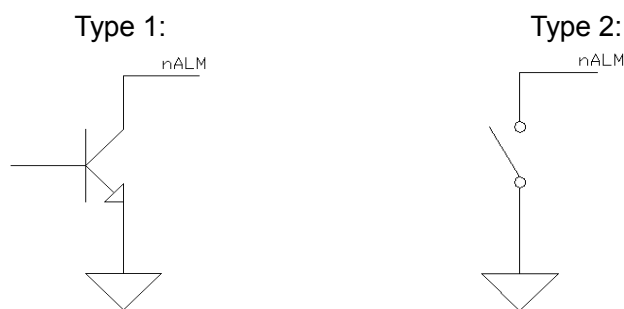

Fig. 2-4 Signal types by drive unit

### 2.1.4 Axis enable signal nEN

nEN signal output is active as CNC works normally (nEN signal to 0V on); when the drive unit alarm or emergency alarm occurs, CNC cuts off nEN signal output (nEN signal to 0V off). The interior interface circuit is shown in Fig. 2-5:

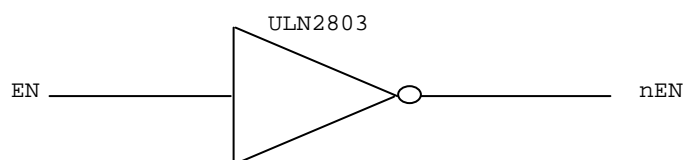

Fig. 2-5 Interior interface circuit for axis enable signal

### 2.1.5 Pulse disable signal nSET

nSET signal is used to control servo input disable which can enhance the anti-disturbance capability between CNC and drive unit. This signal is at low level if there is pulse output from CNC, high resistance if not. The interior interface circuit of it is shown in Fig. 2-6:

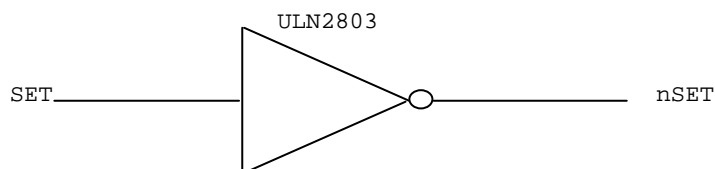

Fig. 2-6 Pulse disable signal circuit

### 2.1.6 Zero signal nPC

During machine zero return, the one-turn or proximity switch signal from the motor encoder is taken as zero signal. Its interior circuit is shown in Fig.2-7.

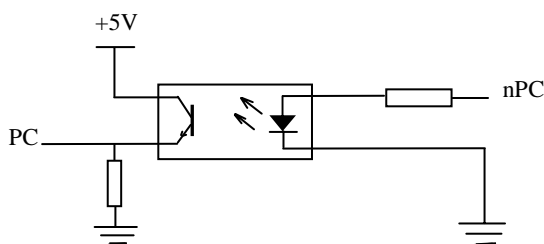

Fig. 2-7 Zero signal circuit

**Note: nPC signal uses +24V level.**

a) The wave of PC signal by user is shown in Fig. 2-8:

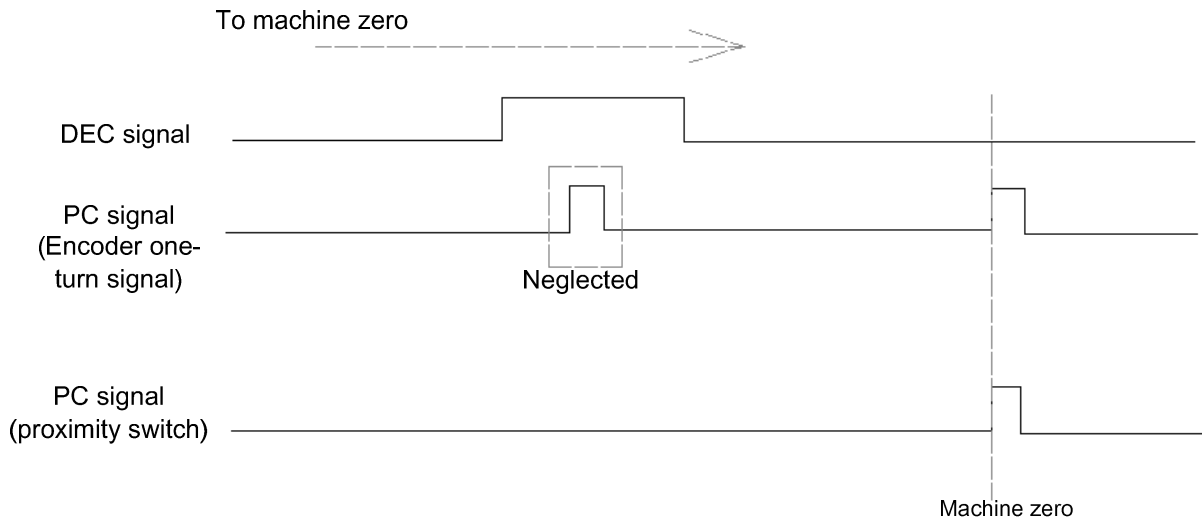

Fig. 2-8 PC signal wave

**Note:** During the machine zero return, the CNC detects the jumping of the PC signal to judge the reference point after the DEC switch is detached, which is active in both rise edge and trailing edge of the wave.

b) The wiring of NPN Hall element taken as both DEC signal and zero signal is shown in Fig. 2-9:

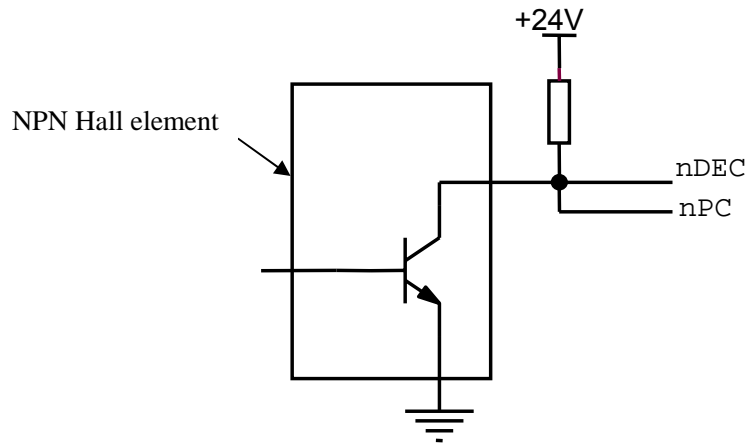

Fig. 2-9 Wiring by a NPN Hall element

c) The wiring of PNP Hall elements taken as both DEC signal and zero signal is shown in Fig. 2-10:

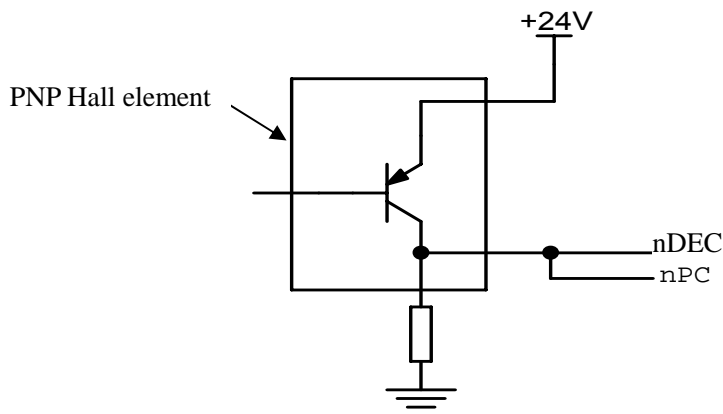
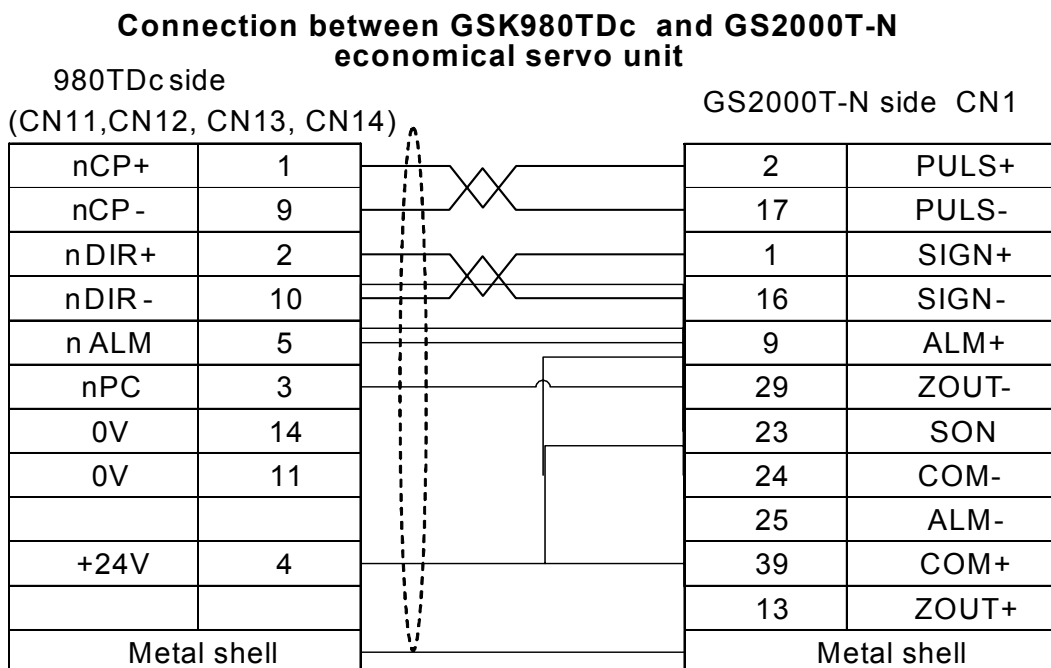

Fig. 2-10 Wiring by a PNP Hall element

### 2.1.7 Connection to a drive unit

GSK 980TDc/GSK980TDc-V is connected with our drive unit, shown in Fig. 2-11:



Note: On 980TDc side, interfaces CN11, CN12, CN13, CN14 adapts 2-stripe male plug; while on GS2000T-N side, CN1 adapts DB44 3-stripe male plug;

#### Connection between GSK980TDc and DA98 (A)

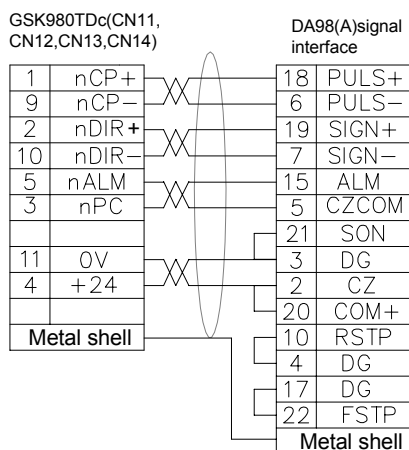

#### Connection between GSK980TDc and DA98B

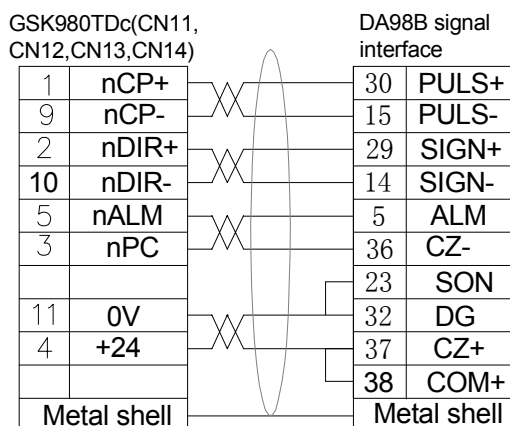

### Connection between GSK980TDc and DY3

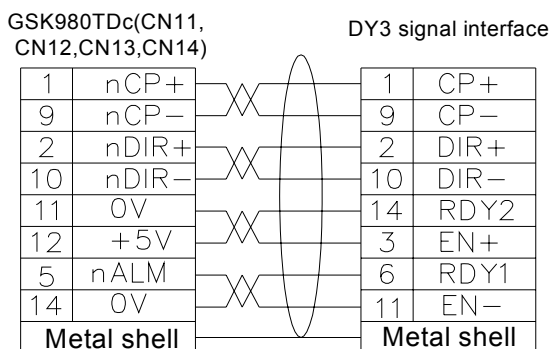

### Connection between GSK980TDc and DF3

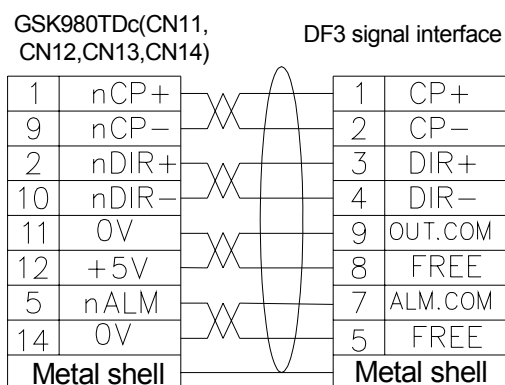

Fig. 2-11 GSK 980TDc/GSK980TDc-V CNC systems are connected with GSK drive unit

## 2.2 Being Connected with Spindle Encoder

### 2.2.1 Spindle encoder interface definition

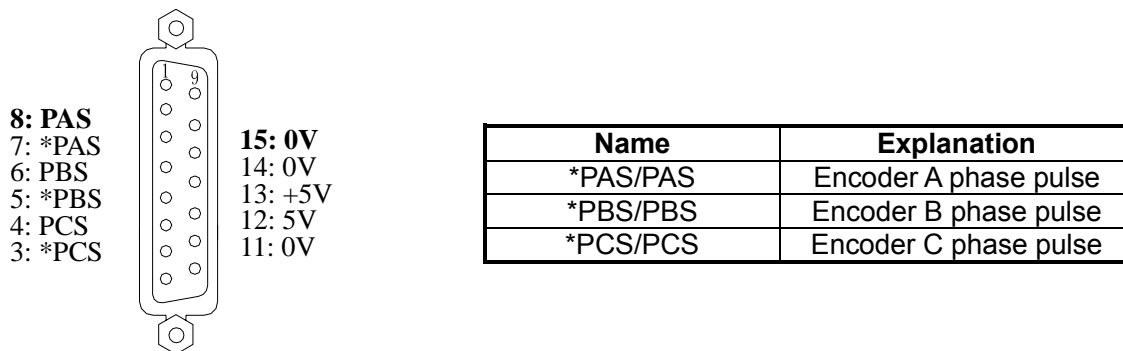

Fig.2-12 CN21 encoder interface (15-core D type male socket)

### 2.2.2 Signal explanation

\*PCS/PCS,\*PBS/PBS,\*PAS/PAS are the encoder C, B, A phases differential input signals respectively, which are received by 26LS32; \*PAS/PAS,\*PBS/PBS are orthogonal square wave with phase shift 90°and their maximum signal frequency is less than 1MHz; the encoder pulses for GSK980TDc are set at will by parameter, the setting range is from 100 to 5000.

Its interior circuit is shown in Fig. 2-13: (n=A, B, C)

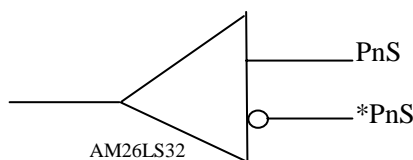

Fig. 2-13 Encoder signal circuit

### 2.2.3 Being connected with spindle encoder interface

GSK980TDc/GSK980TDc-V is connected with spindle encoder shown in Fig. 2-14, and it uses twisted pair cables. (exemplified by CHANGCHUN YIGUANG ZLF-12-102.4BM-C05D encoder):



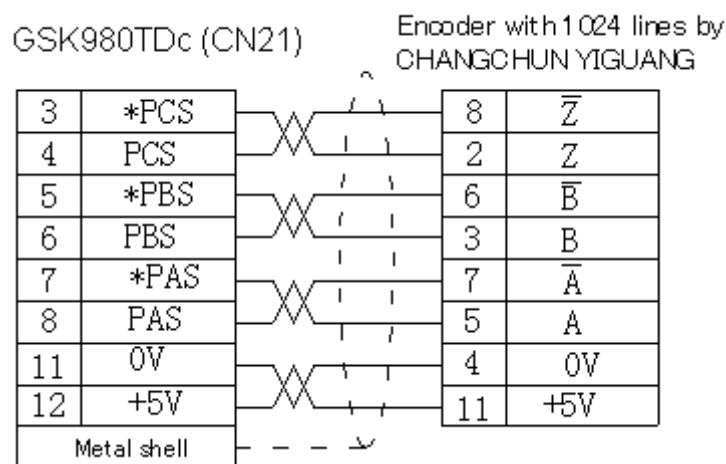

Fig. 2-14 GSK980TDc/GSK980TDc-V is connected with the encoder

## 2.3 Being Connected with MPG (Manual Pulse Generator)

### 2.3.1 MPG interface definition

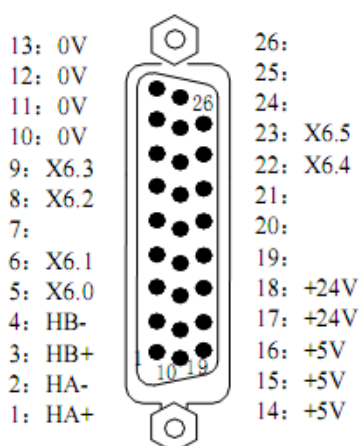

Fig. 2-15 CN31 MPG interface (26-core DB type male socket)

Signal	Explanation
HA+,HA-	MPG A phase signal
HB+,HB-	MPG B phase signal
+24V	DC power supply
+5V,0V	
Standard PLC Definition	
Address	Function
X6.0	X MPG axis selection
X6.1	Y MPG axis selection
X6.2	Z MPG axis selection
X6.3	increment×1
X6.4	increment×10
X6.5	increment×100

### 2.3.2 Signal explanation

HA,HB are the MPG A, B phase input signals respectively. Their interior circuit is shown in Fig. 2-16:

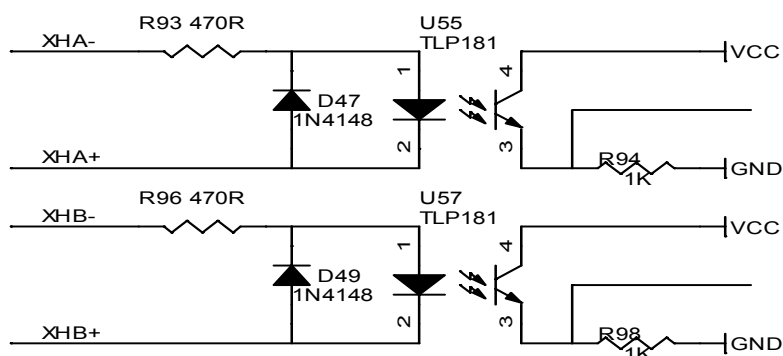

Fig. 2-16 MPG signal circuit

GSK980TDc/GSK980TDc-V is connected with MPG shown in Fig. 2-17:

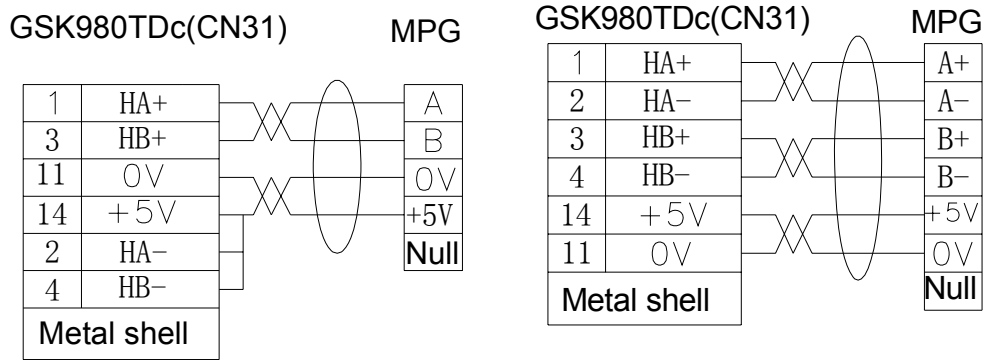

Fig. 2-17 GSK980TDc/GSK980TDc-V is connected with MPG

## 2.4 Spindle Interface

### 2.4.1 Spindle interface definition

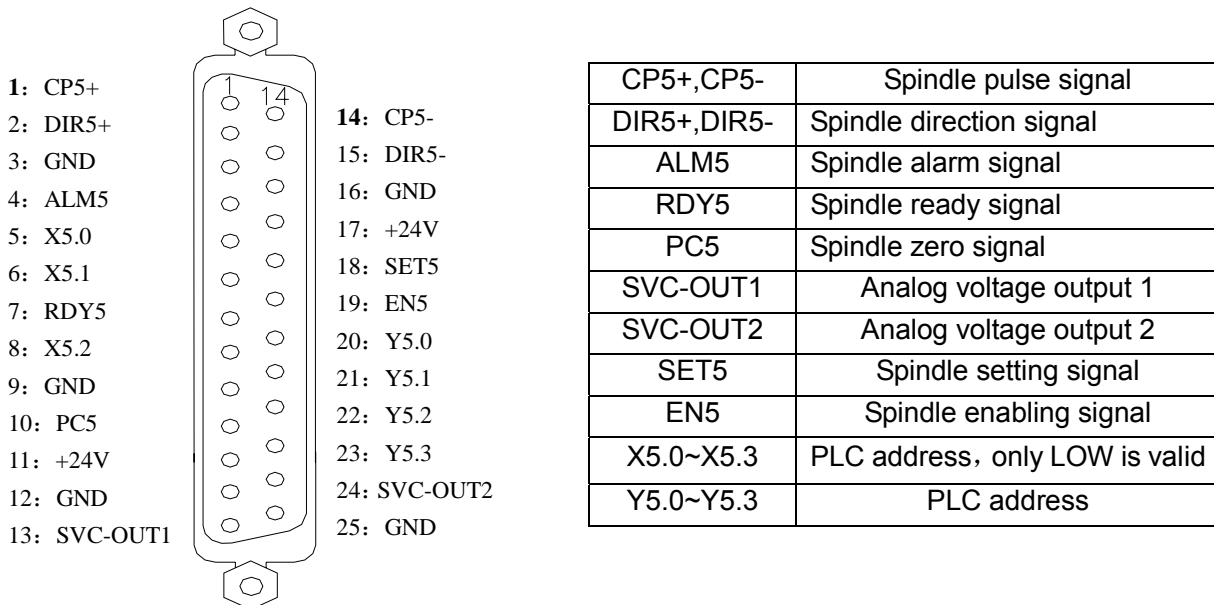

Fig. 2-18 CN15 spindle interface (DB25 female)

**Note 1:** It is valid when PC5 is connected with 0V, and it is different with other feed axes(it is valid when PC of CN11~CN14 axis interface is connected with +24V).

**Note 2:** They are valid when X5.0~X5.3 are connected with 0V, and they are different with other input signals( other are valid when they are connected with +24V).

**Note 3:** The internal circuit of PC5, X5.0~X5.3 signals are shown below:

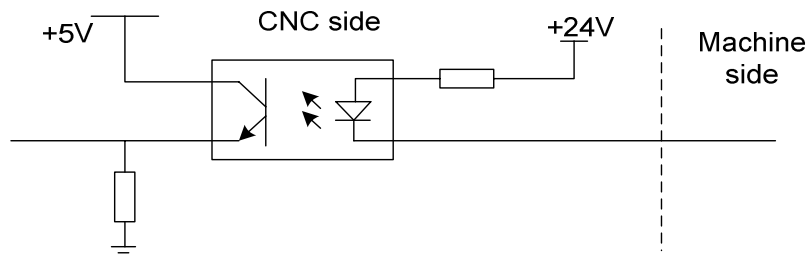

Fig. 2-19 PC5, X5.0~X5.3 circuit

### 2.4.2 Connection to inverter

The analog spindle interface SVC may output 0~10V voltage, its interior signal circuit is shown in Fig. 2-20:

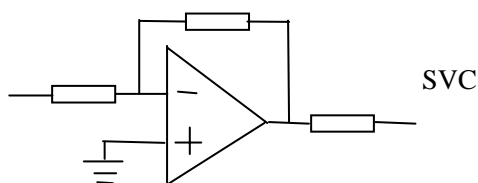

Fig. 2-20 SVC signal circuit

GSK980TDc is connected with the inverter shown in Fig. 2-21:

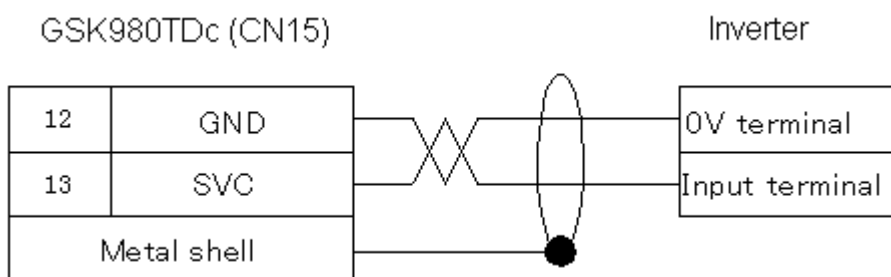

Fig. 2-21 GSK980TDc / GSK980TDc-V is connected with the inverter

## 2.5 GSK980TDc / GSK980TDc-V being Connected with PC

### 2.5.1 Communication interface definition

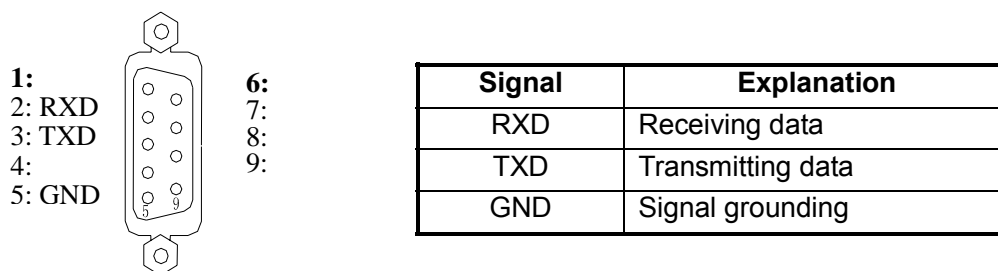

Fig. 2-22 CN51 communication interface (DB9-female)

### 2.5.2 Communication interface connection

GSK980TDc / GSK980TDc-V can perform the communication by CN51 and PC(optional communication software). GSK980TDc/GSK980TDc-V is connected with PC shown in Fig 2-23A:

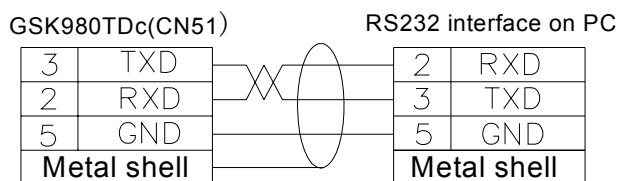

Fig. 2-23A GSK980TDc is connected with PC

## 2.6 Power Interface Connection

GSK-PB2 power box is applied in GSK980TDc system, which involves 4 groups of voltage: +5V(3A) ,+12V(1A) ,-12V(0.5A) ,+24V(0.5A) , and its common terminal is COM(0V) . The connection of GSK-PB2 power box to GSK980TDc XS2 interface has been done for its delivery from factory, and the user only need to connect it to a 220V AC power in using.

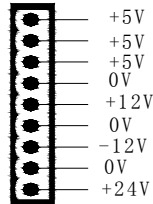

Fig. 2-24 system power interface CN1

## 2.7 I/O Interface Definition

### Note!

The I/O function significances of the unlabelled fixed addresses of this GSK980TDb/GSK980TDb-V turning machine CNC system are defined by PLC programs (ladders), and they are defined by the machine builder when matching with a machine, please refer to the manual by the machine builder.

The fixed address I/O function not be marked are described for GSK980TDb PLC. The described contents without other special explanation are also applied to GSK980TDb-V.

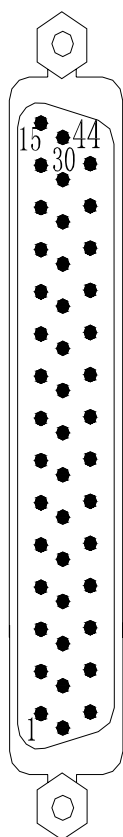

Fig.2-25 input interface(CN61)

Pin	Address	Function	Explanation
21~24	0V	Power supply interface	
17~20 25~28	Floating	Floating	Floating
1	X0.0	SAGT	Guard door check signal
2	X0.1	SP	External feed hold signal
3	X0.2	DIQP	Chuck input signal
4	X0.3	DECX(DEC1)	X deceleration signal
5	X0.4	DITW	Tailstock control signal
6	X0.5	ESP	External emergency stop signal
7	X0.6	PRES	Pressure check signal
8	X0.7	T05	Tool signal /OV1
9	X1.0	T06/ strobe	Tool signal /OV2/strobe signal
10	X1.1	T07/ pregraduation	Tool signal /OV3/pregraduation proximity switch
11	X1.2	T08/ tool post worktable overheat	Tool signal/OV4/ tool worktable overheat check
12	X1.3	DECZ(DEC3)	Z deceleration signal
13	X1.4	ST	External cycle start signal
14	X1.5	M41I	Shifting gear to 1 <sup>st</sup> gear in-position
15	X1.6	M42I	Shifting gear to 2 <sup>nd</sup> gear in-position
16	X1.7	T01	Tool signal
29	X2.0	T02	Tool signal
30	X2.1	T03	Tool signal
31	X2.2	T04	Tool signal
32	X2.3	DECY(DEC2)	Y deceleration signal
33	X2.4	DEC4	4 <sup>th</sup> deceleration signal
34	X2.5	DEC5	5 <sup>th</sup> deceleration signal
35	X2.6	TCP	Tool post clamping signal
36	X2.7	AEY/BDT	External skip
37	X3.0	LMIX	X overtravel
38	X3.1	LMIY	Y overtravel
39	X3.2	LMIZ	Z overtravel
40	X3.3	WQPJ	Inner chuck releasing/outer chuck clamping in-position signal
41	X3.4	NQPJ	Inner chuck clamping/outré chuck releasing in-position signal
42	X3.5	SKIP	G31 skip signal
43	X3.6	AEX	X tool measure position arrival signal (G36)
44	X3.7	AEZ	Z tool measure position arrival signal (G37)

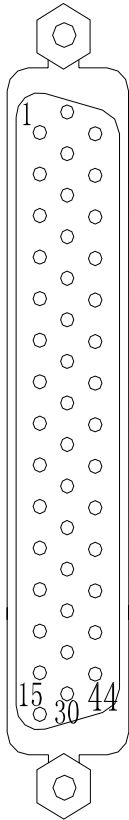

Fig.2-26 output interface (CN62)

Pin	Address	Function	Explanation
17,18,19,26,27,28	0V	Power supply interface	Power supply 0V terminal
20~25	+24V	Power supply interface	Power supply +24V terminal
1	Y0.0	M08	Cooling output
2	Y0.1	M32	Lubricating output
3	Y0.2		Reserved
4	Y0.3	M03	Spindle rotation (CCW)
5	Y0.4	M04	Spindle rotation (CW)
6	Y0.5	M05	Spindle stop
7	Y0.6		reserved
8	Y0.7	SPZD	Spindle brake
9	Y1.0	S1/M41	Spindle machine gear output 1
10	Y1.1	S2/M42	Spindle machine gear output 2
11	Y1.2	S3/M43	Spindle machine gear output 3
12	Y1.3	S4/M44	Spindle machine gear output 4
13	Y1.4	DOQPJ(M12)	Chuck clamping output
14	Y1.5	DOQPS(M13)	Chuck releasing output
15	Y1.6	TL+	Tool post CCW rotation
16	Y1.7	TL-	Tool post CW rotation
29	Y2.0	TZD	Tool post worktable brake
30	Y2.1	INDXS	Tool post worktable graduation coil
31	Y2.2	YLAMP	Three-color lamp-yellow
32	Y2.3	GLAMP	Three-color lamp -green
33	Y2.4	RLAMP	Three-color lamp -red
34	Y2.5	DOTWJ(M10)	Tailstock forward
35	Y2.6	DOTWS(M11)	Tailstock backward
36	Y2.7		reserved
37	Y3.0		reserved
38	Y3.1		reserved
39	Y3.2	UO0	User macro output 0
40	Y3.3	UO1	User macro output 1
41	Y3.4	UO2	User macro output 2
42	Y3.5	UO3	User macro output 3
43	Y3.6	UO4	User macro output 4
44	Y3.7	UO5	User macro output 5

- Note 1:** Various functions can be defined to some of the input and output interfaces, and they are indicated by “/” sign in the table above.
- Note 2:** If output function is active, the output signal is through on to 0V. If output function is inactive, the output signal is cut off by high impedance.
- Note 3:** If input function is active, the input signal is through on to +24V. If input function is inactive, the input signal is cut off with it.
- Note 4:** The effectiveness of +24V, COM terminals are equivalent to those of the GSK980Tdc/GSK980Tdc power box terminals that have the same names.

### 2.7.1 Input signal

Input signal means the signal from machine to CNC, when this signal is through on with +24V, the input is active; when it is off with +24V, the input is inactive. The contact of input signal at machine side should meet the following conditions:

Capacity of the contact: DC30V, 16mA above

Leakage current between contacts in open circuit: 1mA below

Voltage drop between contacts in closed circuit: 2V below (current 8.5mA, including cable voltage drop)

There are two external input types for input signals: one type is input by contact switch whose signals are from keys, stroke switch and contacts of relay at machine side, as shown in Fig. 2-27:

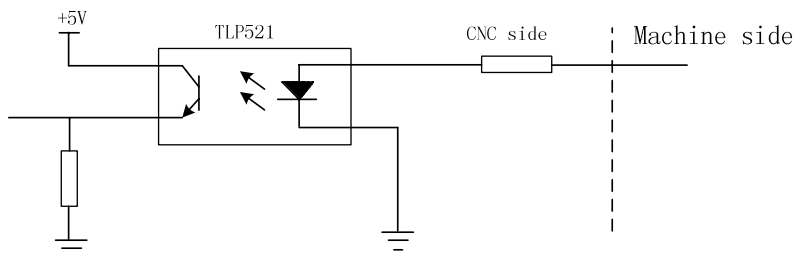

Fig. 2-27

The other type is input by switch with no contacts (transistor) as shown in Fig. 2-28A, 2-28B:

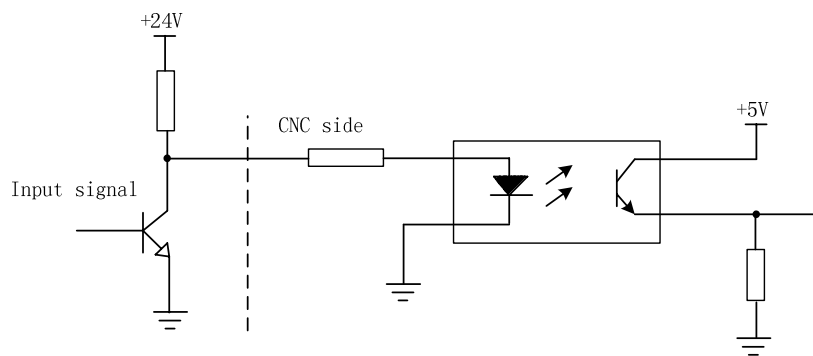

Fig. 2-28A NPN connection

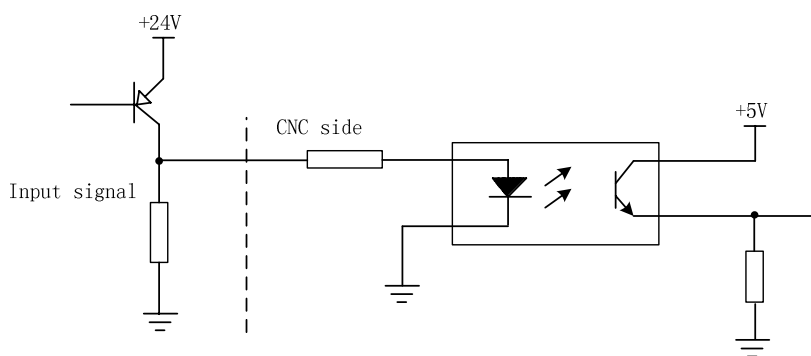

Fig. 2-28B PNP connection

The input interface signals defined by PLC of GSK980TDc / GSK980TDc-V system involve XDEC, ZDEC, ESP, ST, SP/SAGT, PRES, DITW, DIQP, T01~T08, TCP and so on.

### 2.7.2 Output signal

The output signal is used for the machine relay and indicator, if it is through on with 0V, the output function is active; if it is off with 0V, the output function is inactive. There are 36 digital volume outputs that they all have the same structure in I/O interface as shown in Fig. 2-29:

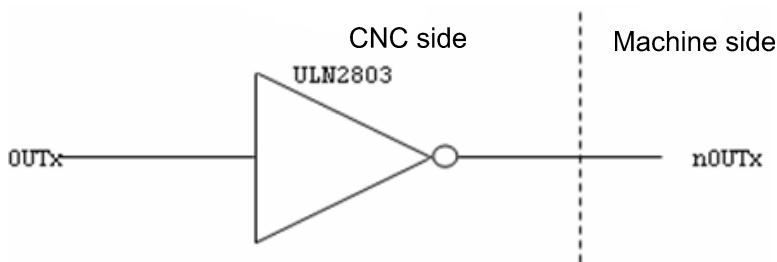

Fig. 2-29 Circuit for digital volume output module

The logic signal OUTx output from the main board is sent to the input terminal of inverter (ULN2803) via a connector. And there are 2 types for nOUTx output: 0V, or high impedance. Its typical application is as follows:

- To drive LED

A serial resistance is needed to limit the current (usually 10mA) that goes through the LED by using ULN2803 output to drive LED, which is shown in Fig. 2-30:

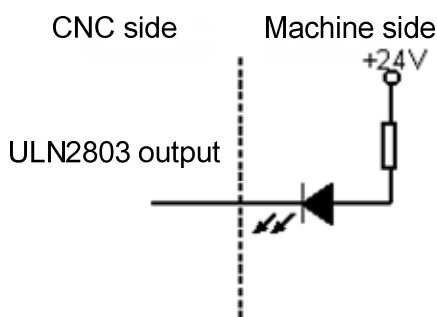

Fig. 2-30

- To drive filament indicator

An external preheat resistance is needed to decrease the current impact at power on by using ULN2803 output to drive filament indicator, and this resistance value should be within a range that the indicator cannot be lighted up as shown in Fig. 2-31:

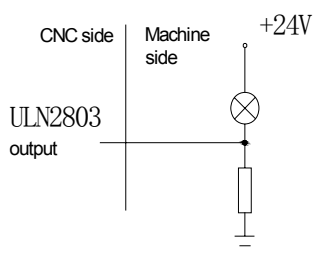

Fig. 2-31

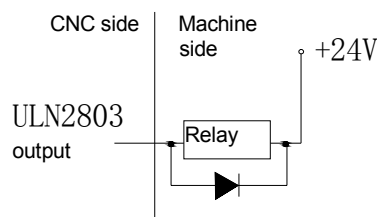

Fig.2-32

- To drive inductive load (such as relay)

To use ULN2803 output to drive an inductive load, it requires to connect a freewheeling diode near the coil to protect output circuit and reduce interference as shown in Fig. 2-32:

The significances of the output signal of I/O interface are defined by PLC program, these signals include S1~S4 (M41~M44), M3, M4, M5, M8, M10, M11, M32, TL-, TL+, U00~U05, DOQPJ, DOQPS, SPZD signals etc.. And their common terminal is +24V.



## 2.8 I/O Function and Connection

**Note !**

The I/O function significance of this GSK980TDb / GSK980TDb-V turning machine CNC system is defined by PLC programs (ladders), and they are defined by the machine builder when matching with a machine, please refer to the manual by the machine builder.

The fixed address I/O function not be marked are described for GSK980TDb PLC. The described contents without other special explanation are also applied to GSK980TDb-V.

### 2.8.1 Stroke limit and emergency stop

- **Relevant signal**

ESP: emergency stop signal, alarm issued if the system is not connected with +24V

LMIX: X overtravel limit check input

LMIY: Y overtravel limit check input

LMIZ: Z overtravel limit check input

- **Diagnosis data**

0	0	0	<b>ESP</b>						
Pin			<b>CN61.6</b>						

- **Signal diagnosis**

Signal	ESP	LMIX	LMIY	LMIZ
<b>Diagnosis address</b>	X0.5	X3.0	X3.1	X3.2
<b>Interface pin</b>	CN61.6	CN61.37	CN61.38	CN61.39

- **Control parameter**

Bit parameter

1	7	2					<b>ESP</b>		
---	---	---	--	--	--	--	------------	--	--

ESP =0: Check ESP signal

=1: Do not check ESP signal

- **PLC bit parameter**

<b>K</b>	1	0	<b>LMIT</b>	<b>LMIS</b>					
----------	---	---	-------------	-------------	--	--	--	--	--

LMIT =1: Travel limit check function of each axis is valid.

=0: Travel limit check function of each axis is invalid

LMIS =1: The system alarms for overtravel when the travel limit check signal is not connected with +24V.

=0: The system alarms for overtravel when the travel limit check signal is connected with +24V

- **Signal connection**

The ESP signal circuit is shown in Fig.2-33:

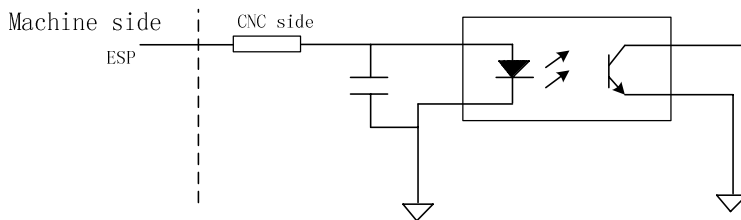

Fig. 2-33 ESP signal circuit

● Machine external connection

(1) The series connection between the emergency stop and travel switch is shown in Fig. 2-34A:

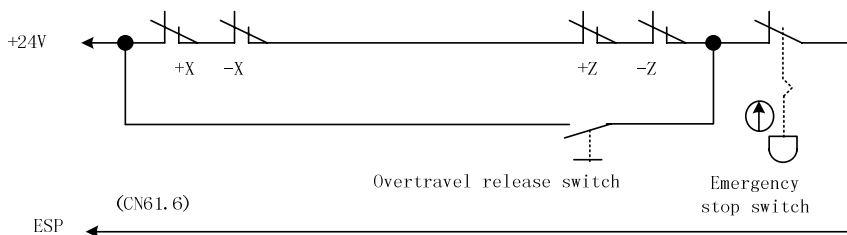

Fig.2-34A Series connection between emergency stop and travel switch

(2) The separate connection between the emergency stop and travel switch is shown in Fig. 2-34B:

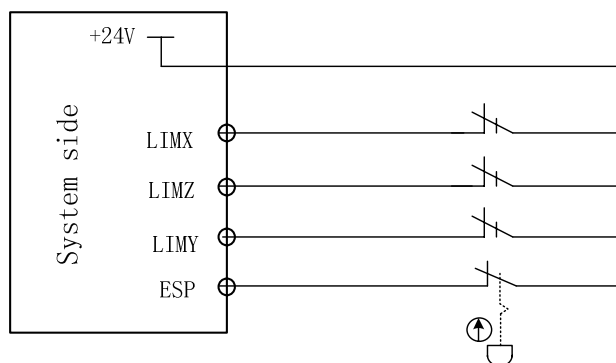

Fig. 2-34B Separate connection between the emergency stop and travel switch

● Control logic

(1) Series connection between the emergency stop and travel switch

When the contact of the emergency stop switch is cut off, the ESP signal is off to +24V, and CNC makes an emergency alarm. Meanwhile the CNC turns off the enable (EN) signal to stop the pulse output. Except the functions processed by NC, other functions can also be defined by PLC program when the emergency alarm is issued. The function defined by standard PLC program is: when emergency alarm is issued, it turns off the signal output of M03, M04, M08, and outputs M05 signal at the same time.

(2) Separate connection between the emergency stop and travel switch

1. Each axis has only one overtravel contact, and the system judges the overtravel alarm based on the axis movement direction.
2. When the system alarms for the overtravel, the axis moves reversely, the reset key is pressed to clear the alarm after the axis exceeds the limit position.

**Note:** Before the overtravel limit function is enabled, the slider must be between the positive and the negative limit; otherwise, the prompted alarm will not be consistent with actual situation.

## 2.8.2 Tool change control

- Relevant signals (by standard PLC program)

Signal type	Code	Interface	Address	Function	Remark
Input signal	T01	CN61.16	X1.7	Tool signal 1 / Sensor A (Liuxin Tool Post)	
	T02	CN61.29	X2.0	Tool signal 2 / Sensor B (Liuxin Tool Post)	
	T03	<b>CN61.30</b>	X2.1	Tool signal 3 / Sensor C (Liuxin Tool Post)	
	T04	CN61.31	X2.2	Tool signal 4 / Sensor D (Liuxin Tool Post)	
	T05	CN61.08	X0.7	Tool signal 5 / Sensor E (Liuxin Tool Post)	Also as OV1 input
	T06	CN61.09	X1.0	Tool signal 6/strobe signal (Yantai AK31) /Sensor F (Liuxin Tool Post)	Also as OV2 input
	T07	CN61.10	X1.1	Tool signal7/pre-graduation proximity switch (Yantai AK31)	Also as OV3 input
	T08	CN61.11	X1.2	Tool signal8/tool post worktable overheat check (Yantai AK31)	Also as OV4 input
	TCP	CN61.35	X2.6	Tool post locking signal	
Output signal	TL+	CN62.15	Y1.6	Tool post rotation(CW) signal	
	TL-	CN62.16	Y1.7	Tool post rotation(CCW) signal	
	TZD/TLS	CN62.29	Y2.0	Tool post worktable brake (Yantai AK31) / tool pot releasing (Liuxin Tool Post)	
	INDXS/TCLP	CN62.30	Y2.1	Tool post worktable pregraduation coil (Yantai AK31) / tool pot lock (Liuxin Tool Post)	

- Control parameter

Bit parameter

<b>K</b>	<b>1</b>	<b>1</b>	<b>CHOT</b>		<b>CHET</b>	<b>TCPS</b>	<b>CTCP</b>	<b>TSGN</b>	<b>CHTB</b>	<b>CHTA</b>
----------	----------	----------	-------------	--	-------------	-------------	-------------	-------------	-------------	-------------

CHTA: tool change mode selection bit 0

CHTB: tool change mode selection bit 1 (see following table)

CHTB	CHTA	Tool post type
0	0	Standard tool change mode B
0	1	Standard tool change mode A
1	0	Yantai AK31
1	1	Unused

TSGN =0 : tool signal HIGH(turn on +24V) is valid

=1 : tool signal LOW(turn off +24V) is valid

CTCP =0 : do not check tool post locking signal

=1 : check tool post locking signal

TCPS =0 : tool post locking signal LOW(turn off +24V) is valid

=1 : tool post locking signal HIGH(turn on +24V) is valid

CHET=0 : do not check tool signal after the tool change is completed

=1 : check tool signal after the tool change is completed  
 CHOT=0 : do not check tool post overheat  
 =1 : check tool post worktable overheat

**D T 0 4** TLMAXT

The maximum time limit for tool change

**D T 0 7** T1TIME

Tool change time T1: Tool post delay time from CCW stop to CW output (ms)

**D T 0 8** TCPCKT

Tool post lock signal detection time (ms)

**D T 0 9** TCPTIME

Tool change time T2: tool post CW rotation locking time

● **Signal connection**

1. The T01~T08, TCP signals input are employed with photocoupler, its interior circuit is shown in Fig. 2-35:

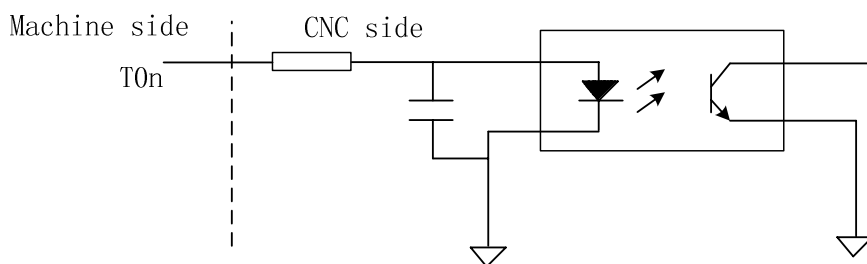

Fig. 2-35

2. TL+, TL- are tool post CCW/CW output signal, its interior circuit is shown in Fig.2-36:

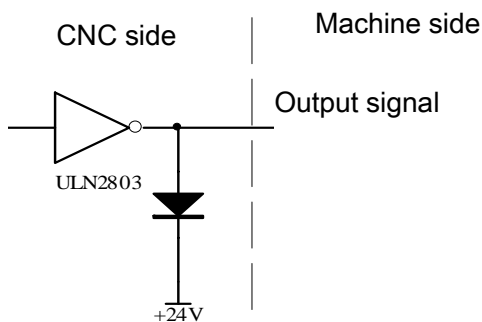

Fig. 2-36

3. The external circuit of the tool number signal is shown in Fig. 2-37, when the tool number signal is low level active, it requires an external pull-up resistor.

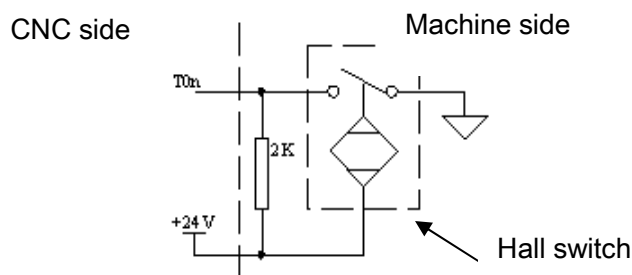

Fig. 2-37

● **Function description (defined by standard PLC program)**

The control sequence and control logic of the tool change are defined by PLC program. There are 4 tool change modes defined as follows by standard PLC program:

**1. CHTB (K11.1)=0, CHTA (K11.0)=0: tool change mode B**

① During the tool change process, CNC outputs TL+ signal until the tool in-position signal is detected, then CNC turns off TL+ signal output and outputs TL- signal after a delay time specified by data parameter No.082. Then CNC detects TCP signal till it is detected, the CNC turns off TL- signal after a delay time specified by the data parameter No.085. So the tool change is over.

② When CHET(K0011.5) is set to 1(check tool signal after the tool change ends) and the tool post (CCW) rotation time ends to confirm whether the current tool input signal is consistent with the current tool No., if not, the system alarms.

③ The tool change process ends.

④ After the system outputs the tool post rotation(CCW)signal, if the CNC doesn't receive the TCP signal within the time set by DT08, an alarm will be issued and the TL- signal will be turned off.

⑤ When the tool post has no tool post locking signal, CTCP(K0011.3) is set to 0, at the time, the system does not check the tool post locking signal.

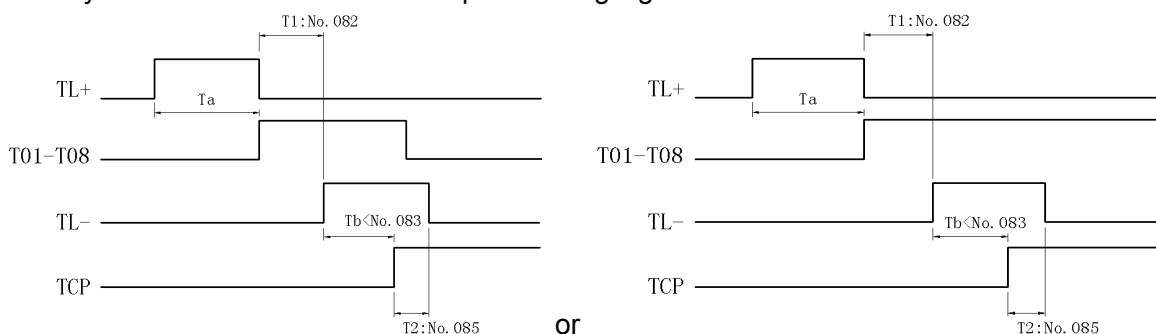

Sequence of tool change mode B

**2. CHTB (K11.1)=0, CHTA (K11.0)=1: tool change mode A:**

① After the tool change is executed, the system outputs the tool rotation(CW)signal TL+ and checks the tool in-position signal, and then after it has checked the tool signal and closes TL+, last checks whether the tool signal skips, if done, it outputs the tool rotation (CCW) signal TL-. Then, the system checks the locking signal TCP, it delays the time set by DT09 and closes TL- after it has received the TCP;

② When CHET (K0011.5) is set to 1 (check tool signal after the tool change ends), the system confirms whether the current tool input signal is consistent with the current tool number after the

tool post (CCW) rotation time ends, if not, the system alarms;

- ③ The tool change process ends.
- ④ After the system outputs the tool rotation (CCW) signal, when it has not received TCP signal in the time set by DT08, it alarms and closes TCP signal.
- ⑤ If the tool post has no locking signal, CTCP (K0011.3) is set to 0, at the time, the system does not check the tool post locking signal.

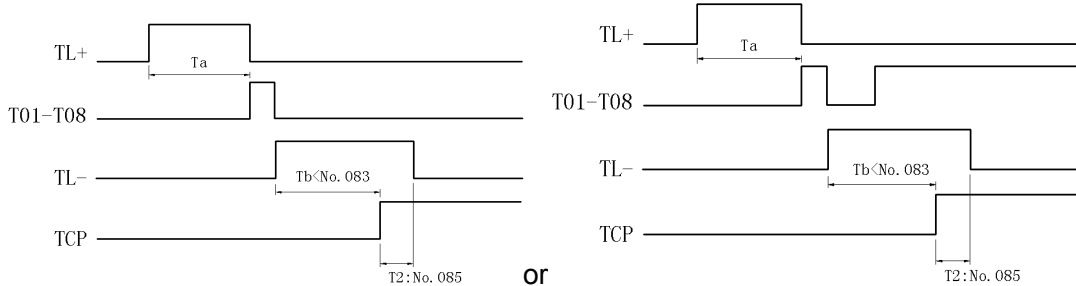

Sequence of tool change mode A

**Note 1:** DT07 setting is invalid, the system does not check in the delay time between the tool post (CW) stop and the tool post (CCW) rotation locked.

**Note 2:** Except for DT07, relative parameter setting and function of other tool post control are valid.

**3.CHTB=1, CHTA =0 : Yantai AK31 series (6, 8, 10, 12 tools) Chanzhou SBWD-80**

a). Tool change process

- (1). Ensure the tool post brake TZD signal is turned on.
- (2). The system executes the shortest path judge based on the target tool no. and the current tool no., and selects the rotation direction of the output according to the nearby tool selection, outputs the positive signal (TL+) or negative signal (TL-), and the tool post rotates to select the tool.
- (3). During the rotation, the system decodes to identify the current tool no. based on the tool encoding signal T1~T4 input. When it rotates to the previous tool before the target tool no., it checks the skip of the tool post strobe signal. The strobe signal of the previous signal before the target tool no. executes the falling edge, the system outputs pregraduation electromagnetic signal of the tool post, and the electromagnet is turned on.
- (4). When the input signal of the pregraduation proximity input signal of the tool post is HIGH, the system closes the tool post rotation output signal (TL+ or TL-), and the motor stops.
- (5). After the system delays 50ms, it outputs the signal (TL- or TL+) which is reverse to the previous rotation direction and the tool post rotates reversely.
- (6). When the proximity input signal of the tool post locked is HIGH, the system closes the rotation signal (TL-, TL+), and the motor stops. Then the system outputs the tool post brake signal TZD, and the motor brake is turned on.
- (7). When the system delays 200ms, it closes the pregraduation electromagnetic output signal, and then the electromagnet is turned off.
- (8). The system checks the current tool no. again and confirms whether the encoding signal of the current tool is consistent with the target tool no..
- (9). The system confirms again whether the locked proximity switch signal is HIGH.
- (10). When the above steps are correct, the system closes the tool post brake signal TZD, and so the tool change is completed.
- (11). In the course of the tool change, when the system has found the motor overheat signal, it

alarms and closes output of all signals.

b). Tool change flow

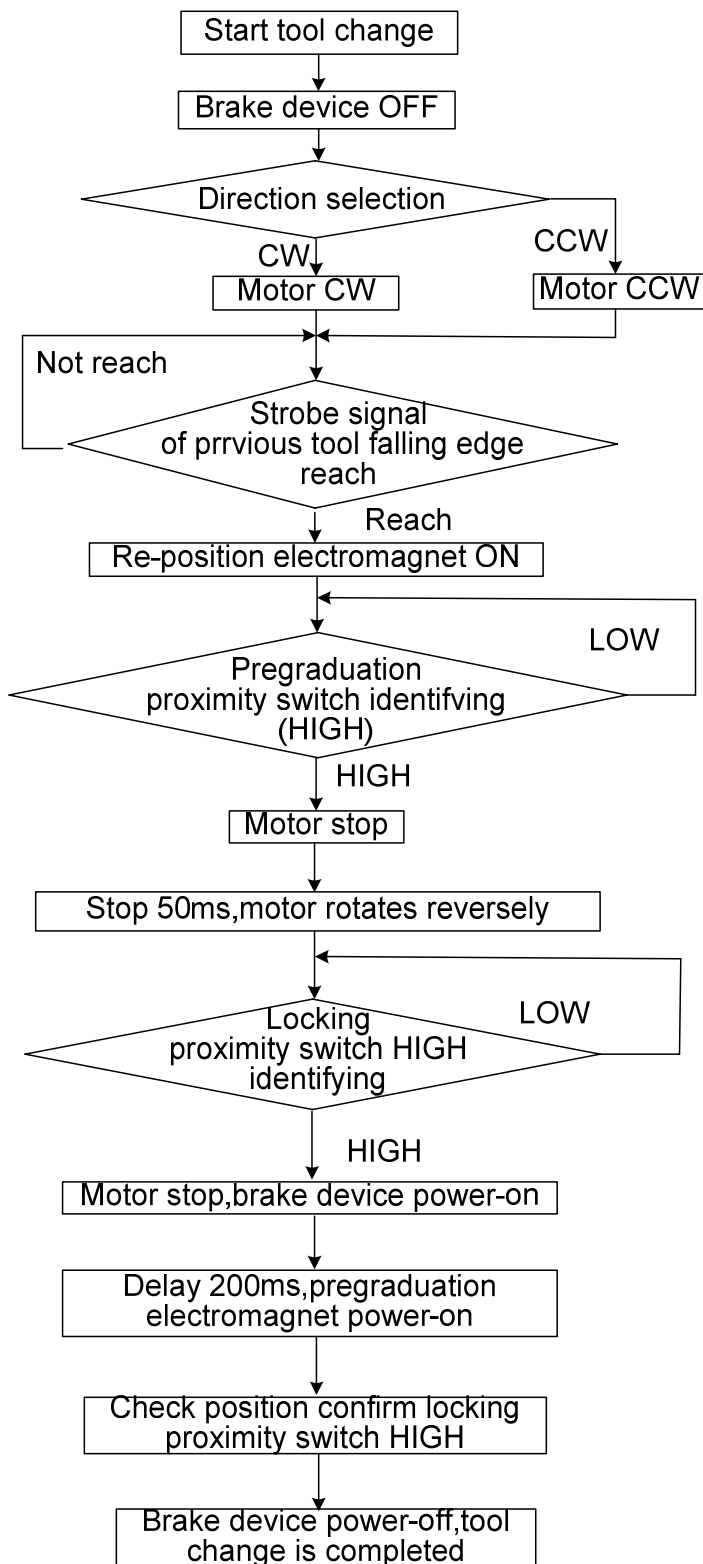

4. CHTB (K11.1)=1, CHTA(K11.0)=1: Liuxin hydraulic tool post

4.1 . Corresponding table between position and signal

8-tool:

	1	2	3	4	5	6	7	8
A			•		•	•	•	
B	•				•		•	•
C				•	•	•		•
D		•				•	•	•
E	•	•	•	•	•	•	•	•

10-tool:

	1	2	3	4	5	6	7	8	9	10
A			•		•	•	•		•	
B	•				•		•	•	•	
C				•	•	•		•		•
D		•				•	•	•		•
E	•	•	•	•	•	•	•	•	•	•

12-tool:

	1	2	3	4	5	6	7	8	9	10	11	12
A	•			•	•		•	•	•			
B			•			•	•		•	•	•	
C		•			•	•		•	•	•		
D				•			•	•		•	•	•
E	•	•	•	•	•	•	•	•	•	•	•	•

4.2 Signal specification

Sensor A, B, C, D: only check the tool, and are not any start signals

Sensor E: it executes the inductive once when one tool change is executed, which makes the tool pot stop and the start signal be locked. When the tool pot rotates to the required position, Sensor is inductive, i.e. the electromagnet to control the tool pot rotation is turned off, which makes the tool stop rotation and start the electromagnet to lock the tool pot to ensure that the tool pot is locked.

Sensor F: releasing/lock confirmation signal. When it is not inductive, the tool pot is released, at the time, the tool pot is started to rotate. When it is not inductive, the tool pot is locked, i.e. the tool change is completed.

Sol A: control the tool pot releasing/locking

Sol B: control the tool pot rotation(CW/CCW)

4.3 Tool change process description

Example: No. 1 tool is changed into No. 4 tool

Step 1: Sol A is turned on(tool pot is released)

Step 2: Ensure Sensor F is not inductive, Sol B is turned and the oil hydraulic motor rotates

Step 3: check the tool signal(Note: Sensor E is inductive for No. 1, 2, 3 tool, does not execute the locking operation when the tool pot does not reach No. 4 tool). When No. 3 tool signal is confirmed, Sensor E preparatory operation should be set to make the tool pot rotate to No.4 tool, at the time, Sensor E is inductive, i.e. Sol B is turned on, the tool pot stops rotation and Sol A makes the tool pot be locked.



### 2.8.3 Machine zero return

- Relative signal  
 DECX: X deceleration signal;  
 DECY: Y deceleration signal;  
 DECZ: Z deceleration signal;  
 DEC4: 4th deceleration signal;  
 DEC5: 5th deceleration signal;  
 PCX: X zero signal;  
 PCY: Y zero signal;  
 PCZ: Z zero signal;  
 PC4: 4th zero signal;  
 PC5: 5th zero signal;
- Diagnosis data

0	0	0				DEC5	DEC4	DECZ	DECY	DECX
Interface pin						CN61.34	CN61.33	CN61.12	CN61.32	CN61.4
0	0	8				PC5	PC4	PCY	PCZ	PCX
Interface pin						CN15.10	CN14.3	CN13.3	CN12.3	CN11.3

- Controlling parameter

Status parameters

0	0	4				DECI				
---	---	---	--	--	--	------	--	--	--	--

Bit 5 1: During machine zero return, the deceleration signal is at high level;  
 0: During machine zero return, the deceleration signal is at low level;

0	0	5						PPD		
---	---	---	--	--	--	--	--	-----	--	--

Bit 1: 1: G50 sets relative coordinate system value;  
 0: G50 does not set relative coordinate system value;

0	0	6				ZM5	ZM4	ZMY	ZMZ	ZMX
---	---	---	--	--	--	-----	-----	-----	-----	-----

Bit4 1: 5<sup>th</sup> axis zero point return method C  
 0: 5<sup>th</sup> axis zero point return method B  
 Bit3 1: 4<sup>th</sup> axis zero point return method C  
 0: 4<sup>th</sup> axis zero point return method B  
 Bit2 1: Y axis zero point return method C  
 0: Y axis zero point return method B  
 Bit1 1: Y axis zero point return method C  
 0: Y axis zero point return method B  
 Bit0 1: X axis zero point return method C  
 0: X axis zero point return method B

0	0	7				ZC5	ZC4	ZCY	ZCZ	ZCX
---	---	---	--	--	--	-----	-----	-----	-----	-----

Bit 4 1: During machine zero return, the deceleration signal of the 5<sup>th</sup> axis (DEC5) and one-rotation signal (PC5) are connected in parallel (use a proximity switch as a deceleration signal and zero-point signal at the same time).  
 0: During machine zero return, the deceleration signal of the 5<sup>th</sup> axis (DEC5) and one-rotation signal (PC5) are connected separately (use a proximity switch as a deceleration signal and zero-point signal at the same time).

- Bit 3 1: During machine zero return, the deceleration signal of the 4<sup>th</sup> axis (DEC4) and one-rotation signal (PC4) are connected in parallel (use a proximity switch as a deceleration signal and zero-point signal at the same time).  
 0: During machine zero return, the deceleration signal of the 4<sup>th</sup> axis (DEC4) and one-rotation signal (PC4) are connected separately (use a proximity switch as a deceleration signal and zero-point signal at the same time).
- Bit 2 1: During machine zero return, the deceleration signal of the Y axis (DECY) and one-rotation signal (PCY) are connected in parallel (use a proximity switch as a deceleration signal and zero-point signal at the same time).  
 0: During machine zero return, the deceleration signal of the Y axis (DECY) and one-rotation signal (PCY) are connected separately (use a proximity switch as a deceleration signal and zero-point signal at the same time).
- Bit 1 1: During machine zero return, the deceleration signal of the Z axis (DECZ) and one-rotation signal (PCZ) are connected in parallel (use a proximity switch as a deceleration signal and zero-point signal at the same time).  
 0: During machine zero return, the deceleration signal of the Z axis (DECZ) and one-rotation signal (PCZ) are connected separately (use a proximity switch as a deceleration signal and zero-point signal at the same time).
- Bit 0 1: During machine zero return, the deceleration signal of the X axis (DECX) and one-rotation signal (PCX) are connected in parallel (use a proximity switch as a deceleration signal and zero-point signal at the same time).  
 0: During machine zero return, the deceleration signal of the X axis (DECX) and one-rotation signal (PCX) are connected separately (use a proximity switch as a deceleration signal and zero-point signal at the same time).

III Connection

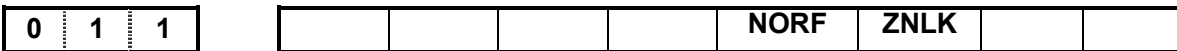

- Bit3 1: Manual machine zero return is invalid;  
 0: Manual machine zero return is valid;
- Bit 2: 1: The direction key is self-locked during machine zero return; press the direction key once till the machine zero return is finished;  
 0: The direction key is not self-locked during machine zero return; press down the direction key;



- Bit 7 1: CNC sets the absolute coordinate system automatically after reference point return;  
 0: CNC does not set absolute coordinate system automatically after reference point return;
- Bit 0 1: Manual rapid traverse is valid after system power-on and before machine zero return;  
 0: Manual rapid traverse is invalid after system power-on and before machine zero return;

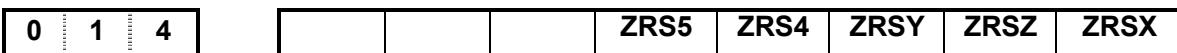

- Bit4, Bit3, Bit2, Bit1, Bit0  
 1: Machine zero point is set on the 5<sup>th</sup>, 4<sup>th</sup>, Y, Z, X axes; deceleration signal and zero point signal are needed to be detected during machine zero return;  
 0: Machine zero point is not set on the 5<sup>th</sup>, 4<sup>th</sup>, Y, Z, X axes; deceleration signal and zero point signal are not detected during machine zero return;



- Bit4/Bit3/Bit2/Bit1/Bit0 1: The direction of machine zero return is negative;  
 0: The direction of machine zero return is positive;

Data parameters			
0	3	3	ZRNFLn
The low speed of machine zero return;			
1	1	3	REF_SPDn
The high speed of machine zero return;			
0	4	7	PRSn
Setting value of absolute coordinate after machine zero return;			

● **Signal connection**

The interior circuit of deceleration signal is shown in Fig. 2-38:

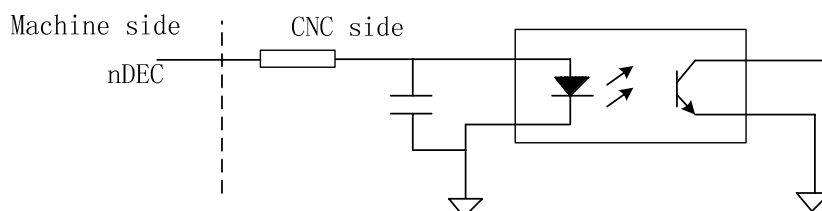

Fig. 2-38

● **Machine zero return by regarding servo motor one-turn signal as the zero signal**

① Its sketch map is shown below:

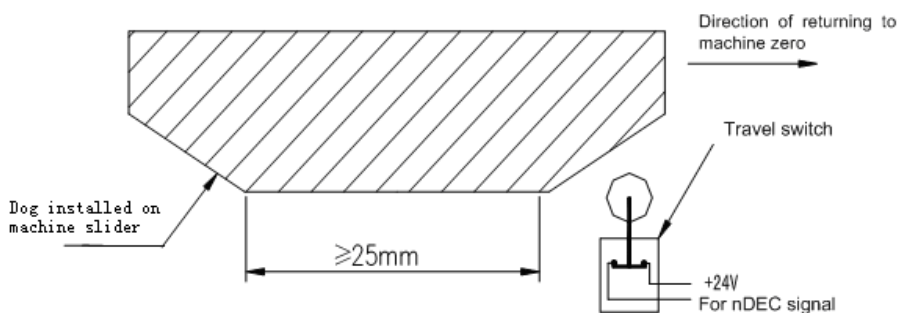

Fig. 2-39

② The circuit of deceleration signal

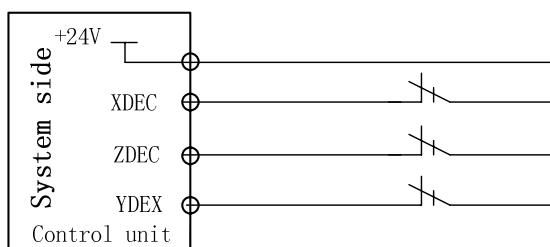

Fig. 2-40

③ Sequence of machine zero return

When the BIT0 (ZMX) of the bit parameter No.006 is set to 0, and the BIT5(DEC1) of the bit parameter No.004 is set to 0, the system chooses the machine zero return mode B, and the deceleration signal low level is active.

So the sequence of machine zero return mode B is shown as follows:

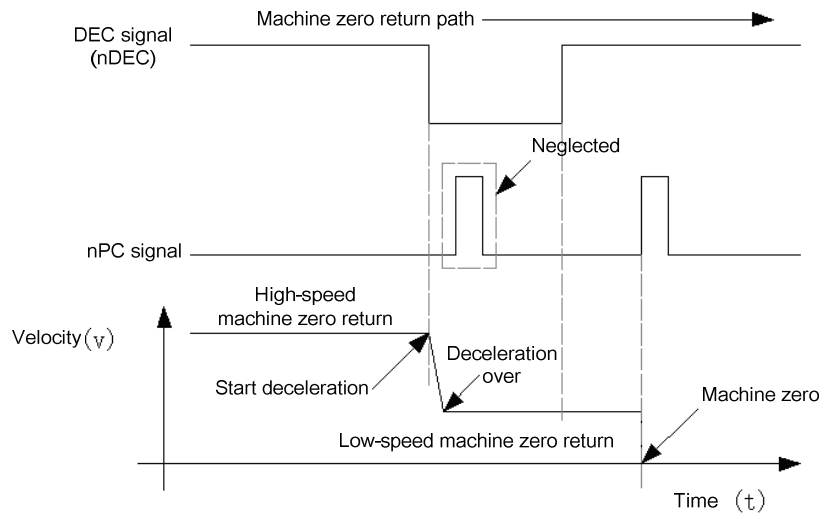

Fig. 2-41-a

Return process of machine zero mode B

- A: Select Machine zero mode, press the manual positive or negative feed key(machine zero return direction set by bit parameter No.183), the corresponding axis moves to the machine zero by a rapid traverse speed. As the axis press down the deceleration switch to cut off deceleration signal, the feeding slows down immediately, and it continues to run in a fixed low speed.
- B: When the deceleration switch is released, the deceleration signal contact is closed again. And CNC begins to detect the encoder one-turn signal (PC), if this signal level skips, the motion will be halted. And the corresponding zero return indicator on the operator panel lights up for machine zero return completion.

When the BIT0 (ZMX) of the bit parameter No.006 are both set to 1, and the BIT5(DECLI) of the bit parameter No.004 is set to 0, it chooses the machine zero return mode C, and the deceleration signal low level is active.

So the sequence of machine zero return mode C is shown as follows:

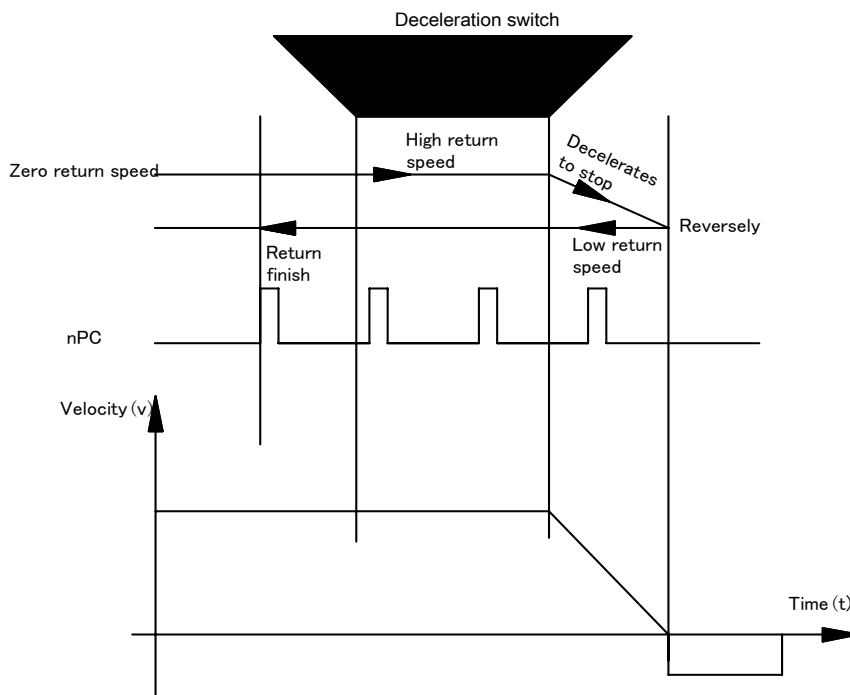

Fig. 2-41-b

Return process of machine zero mode C

- A: Select Machine zero mode, press the manual positive or negative feed key (return direction set by bit parameter No.183), the corresponding axis moves to the machine zero by a rapid traverse speed. As the axis press down the deceleration switch to cut off deceleration signal, the feeding keeps rapid rate and depart from the deceleration switch, when the DEC signal contact is closed, the feeding slows down to zero, then run reversely to return to machine zero in a low speed.
- B: In the reverse running, it presses down the deceleration switch to cut off the DEC signal contact and continues returning; as it departs from the deceleration switch, the deceleration signal contact is closed again. And CNC begins to detect the encoder one-turn signal (PC), if this signal level skips, the motion will be halted. And the corresponding axis zero return indicator on the operation panel lights up for zero return completion.

● **Machine zero return by a proximity switch taken as both deceleration and zero signals**

① Its sketch map is as follows:

Sketch map of zero tongue for machine zero return mode B:

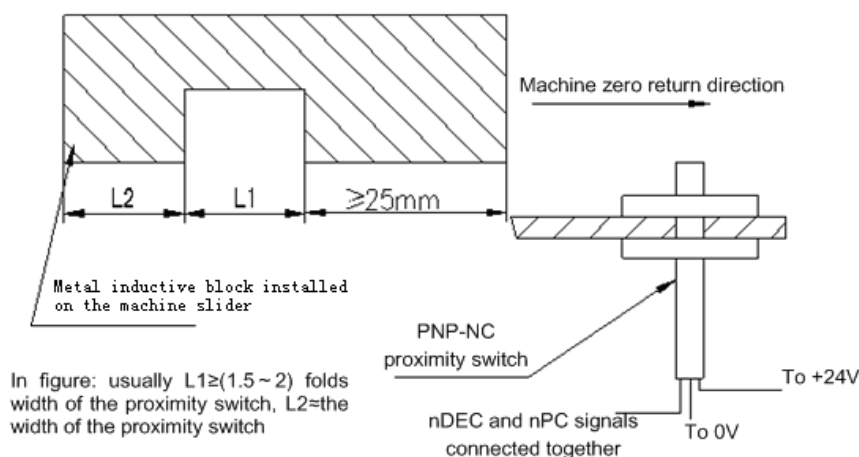

Fig. 2-42-a

Sketch map of zero tongue for machine zero return mode C:

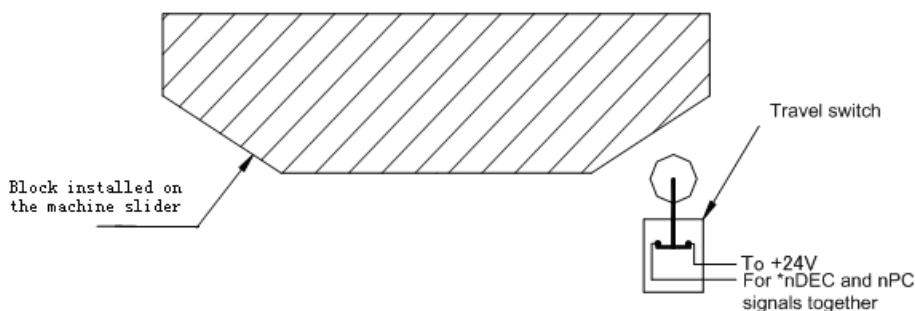

Fig. 2-42-b

② Circuit of the deceleration signal

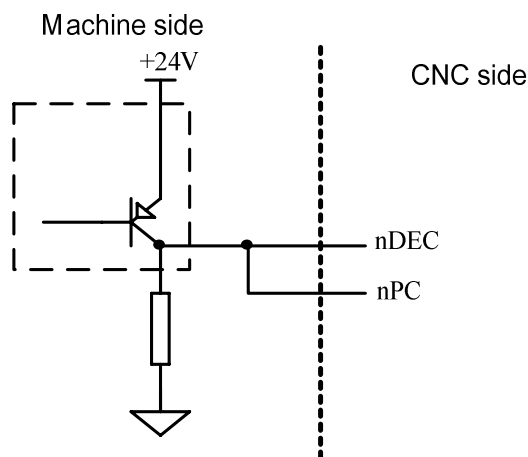

Fig. 2-43

③ Sequence of machine zero return (taking example of X)

When the BIT0(ZMX) of the bit parameter No.006 are all set to 0, and the BIT5(DEC1) of the bit parameter No.004 is 0, it chooses the machine zero return mode B.

The sequence of machine zero return is as follows:

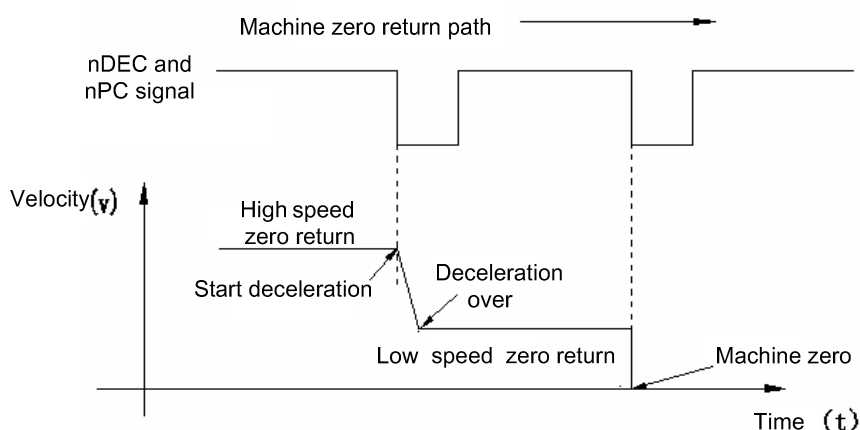

Fig. 2-44-a

B type machine zero return process

- A: Select the Machine Zero mode, press manual positive or negative (zero return direction set by bit parameter No.183) feed key, the corresponding axis will move to the zero at a high speed (set by parameter No.113).
- B: As the proximity switch touches the tongue for the first time, the deceleration signal is active and speed immediately slows down and it runs in a fixed low speed (set by parameter No.33).
- C: As the proximity switch detaches the tongue, the deceleration signal is inactive, it moves at a fixed low speed after deceleration and starts to detect zero signal (PC).
- D: As the proximity switch touches the tongue for the second time, the zero signal is active and the movement stops. The zero return indicator on the panel lights up for machine zero return completion.

When the BIT0(ZMX) of the bit parameter No.006 are all set to 1, and the BIT5(DEC1) of the bit parameter No.004 is 0, it chooses the machine zero return mode C.

The sequence of machine zero return mode C is shown as follows:

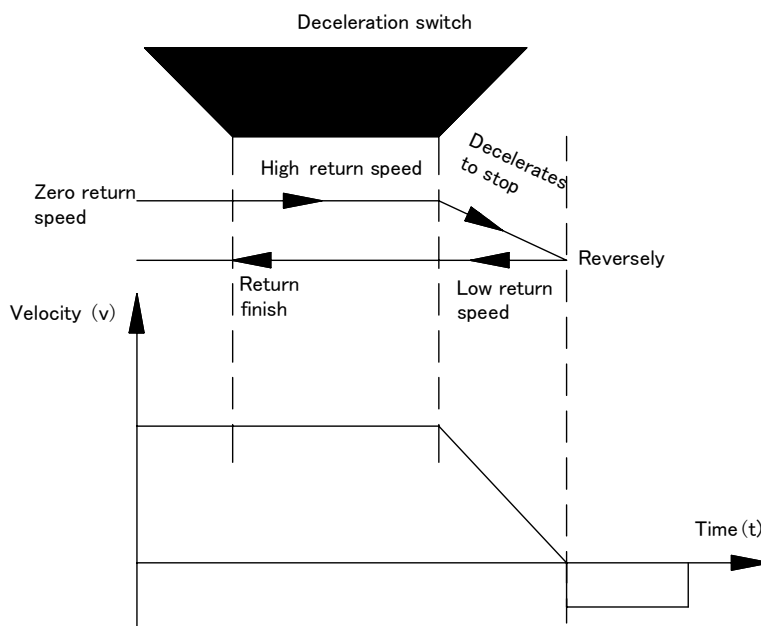

Fig. 2-44-b

C type machine zero return process

- A: Select the Machine Zero mode, press manual positive or negative (zero return direction set by bit parameter No.183) feed key, the corresponding axis will move to the zero at a high speed(set by parameter No.113).
- B: As the proximity switch touches the tongue for the first time, the deceleration signal is active. The speed doesn't slow down and it traverses on.
- C: As the proximity switch detaches the deceleration switch, deceleration signal contact is closed, the feed speed decelerates to zero, then it runs reversely by low return speed.
- D: As the proximity switch touches the deceleration switch for the second time in reverse running, deceleration signal contact is cut off, it still runs by low return speed; as it detaches the deceleration switch, deceleration signal contact is closed again, so the movement stops. The zero return indicator for the corresponding axis on the panel lights up for zero return completion.

### 2.8.4 Spindle control

● Relevant signal (by standard PLC program)

Type	Symbol	Interface	Address	Function	Remark
Input signal	SAR	CN15.6	X5.1	Spindle speed arrival signal	It is valid when 0V is input
	SALM	CN15.4	X5.3	Spindle abnormality alarm input	
Output signal	M03	CN62.4	Y0.3	Spindle rotation(CCW)	
	M04	CN62.5	Y0.4	Spindle rotation(CW)	
	M05	CN62.6	Y0.5	Spindle stop	
	SCLP	CN62.7	Y0.6	Spindle clamped	
	SPZD	CN62.8	Y0.7	Spindle brake	
	SVF	CN62.37	Y3.0	Spindle servo OFF	
	SFR	CN15.22	Y5.2	Spindle rotation(CW)	Its function is consistent with that of M03

	SRV	CN15.23	Y5.3	Spindle rotation(CCW)	Its function is consistent with that of M04
Command format	M03			Spindle rotation(CCW)	
	M04			Spindle rotation(CW)	
	M05			Spindle stop	
	M20			Spindle clamped	They are valid in analog spindle
	M21			Spindle released	

● Control parameter

Bit parameter

**K 1 0**              **RSJG**

RSJG =1: CNC not turn off M03, M04, M08, M32 output signals when pressing  key;

=0: CNC turns off M03, M04, M08, M32 output signals when pressing  key.

**K 1 7**       **SCLP**  **SALM** **SSTP** **SONC**

SCLP =1: The spindle clamped command executes clamping the 2<sup>nd</sup> spindle when the multi-spindle is valid.

=0: The spindle clamped command executes clamping the 1<sup>st</sup> spindle when the multi-spindle is valid.

SALM =1: The system alarms when the spindle abnormal detection input signal is LOW (it is turned off with 0V);

=0: The system alarms when the spindle abnormal detection input signal is HIGH (it is turned on with 0V) .

SSTP =1: The analog voltage is closed when the spindle stops;

=0: The analog voltage is not closed when the spindle stops.

SONC = 1: Spindle is disabled when clamping

= 0: Spindle motor torque decreases to 0 when spindle is clamping;

**1 7 5**       **SAR**

Bit6 1: The spindle SAR signal is checked before cutting;

0: The spindle SAR signal is not checked before cutting.

Data parameter

**0 7 2**       **SAR\_DELEY**

Delay check time (ms) of the spindle speed arrival.

**D T 0 5**       **MTIME**

Execution time of M code (ms)

**D T 1 0**       **SPDDL T**

Spindle braking delay output time after spindle stop (M05) is output

**D T 1 1**       **SPZD TIME**

Spindle braking output time (ms)



**D T 2 3** SVF\_DELEY

Delay time before spindle motor torque decrease to 0 when spindle starts clamping;

**D C 0 0** SPZERO

Spindle zero speed output range (m/min);

● **Signal connection**

M03, M04, M05, SPZD signal output circuit is shown in Fig. 2-45A:

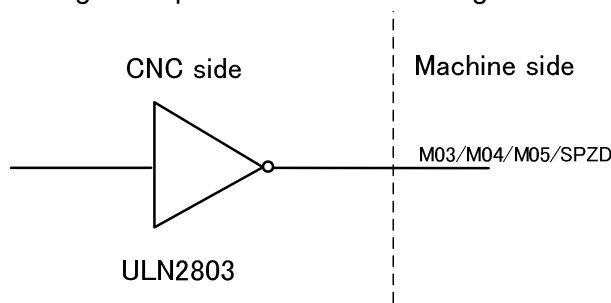

Fig. 2-45A

SAR, SALM signal input circuit is shown in Fig.2-45B:

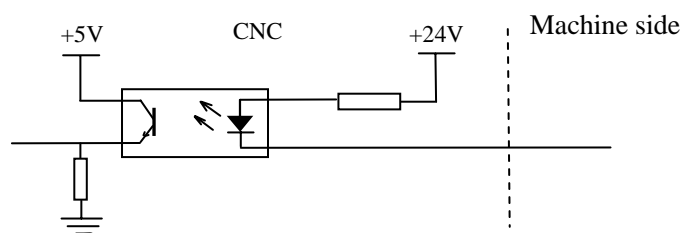

Fig.2-45B

● **Operation sequence (defined by standard PLC program)**

Spindle operation sequence is shown in Fig 2-46:

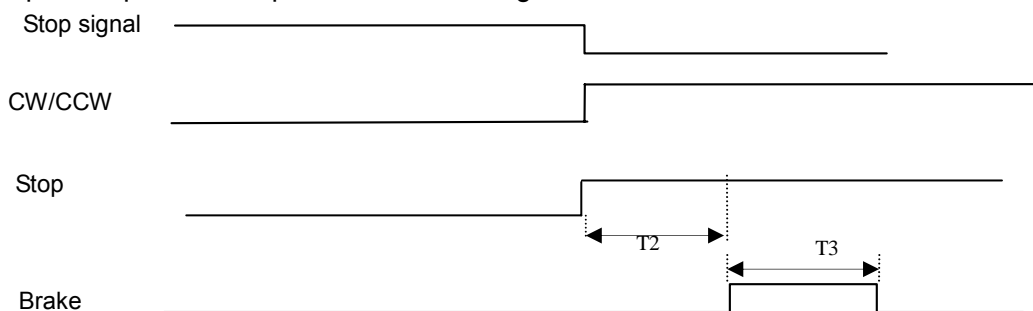

Fig. 2-46 spindle rotation(CW/CCW) sequence

**Note:** T2 is the delay time from sending the spindle stop signal to sending the spindle brake signal; T3 is the spindle brake hold time.

● **Function description (defined by standard PLC program)**

① After the CNC is turned on, when M05 output is valid, M03 or M04 is executed, M03 or M04 output is valid and remains, at the time, M05 output is closed; when M03 or M04 output is valid, M05 is executed, M03 or M04 is closed, M05 output is valid and remains; the spindle brake SPZD signal output delay is set by No.087 (delay time from the spindle stop signal output to the spindle brake SPZD signal output), the hold time of the brake signal is set by No. 089 (the spindle brake output time).

- ② When M03 (M04) output is valid, M04 (M03) is executed, the alarm occurs.
- ③ When №175.6 is set to 1, the system checks whether the speed arrival signal SAR is valid, if it is valid, the system normally runs, if not, "Check speed arrival....." is displayed.
- ④ When the spindle speed command and the cutting feed command are in the same block, the system executes the delay check for SAR signal to avoid that the CNC starts the cutting based on the last spindle speed arrival signal SAR, the delay time is set by No.072.
- ⑤ DC00 is the spindle zero-speed output range. When the actual spindle speed is not more than DC00 setting value, the system defaults the spindle speed to be zero, and can release the chuck, close the hydraulic and other operations.
- ⑥ M20 and M21 are separate the spindle clamping and releasing command, used to clamp the spindle after positioning, which can avoid that the spindle rotates because of the force in drilling or tapping.
- ⑦ When M20 is executed, the spindle is clamped. To avoid that the spindle servo motor has too much current, the system delays the time set by DT23 and then controls the spindle to turn off the servo, at the time, the spindle servo reduces the motor excitation and the position control cannot be executed, but the position check is still enabled and the position is not lost.
- ⑧ When the spindle moves or rotates, M20(spindle clamped) cannot be executed. After the spindle is clamped, it cannot be rotated or moved, otherwise, the PLC alarms.
- ⑨ When K17.6 sets the spindle to be clamped, the clamped is the 1<sup>st</sup> or 2<sup>nd</sup> spindle, which is set based on the actual conditions.
- ⑩ SALM (X5.3) is the alarm input signal of the spindle abnormality, the signal and the drive alarm signal of the 5<sup>th</sup> axis use the same interface. When the 5<sup>th</sup> axis is valid, the interface is used to the 5<sup>th</sup> drive alarm; when the 5<sup>th</sup> axis is invalid, the interface is used to the spindle abnormality alarm.

**Note 1:** In the emergency stop, it turns off M03, M04, M08 signals, and outputs M05 signal;  
**Note 2:** Whether M03, M04 is cancelled is set by BIT3 of the bit parameter No.009 when CNC is reset.  
 If Bit 1=0, CNC turns off M03, M04 at reset;  
 If Bit 1=1, M03, M04 is kept at reset.

### 2.8.5 Spindle switching volume control

- **Relevant signal(defined by standard PLC program)**  
 S01~S04: Control signal for spindle speed switching volume, they are compound interfaces defined by standard PLC program, and they share common interfaces with M41~M44, U00~U03.

- **Signal diagnosis**

<b>Signal</b>	S4	S3	S2	S1
<b>Diagnosis address</b>	Y1.3	Y1.2	Y1.1	Y1.0
<b>Interface pin</b>	CN62.12	CN62.11	CN62.10	CN62.09

- **Control parameters**

Bit parameter

0	0	1				<b>ACS</b>				
---	---	---	--	--	--	------------	--	--	--	--

Bit4 =1: Analog voltage control of spindle speed  
 =0: Switching volume control of spindle speed

- **Control logic (defined by standard PLC program)**

S1~S4 output are inactive at power on. If any code of them is executed, the corresponding S signal output is active and held on, and the other S signal outputs are cancelled. S1~S4 outputs are cancelled when executing S00 code, and only one of them is active at a time.

### 2.8.6 Spindle automatic gearing control

- **Relevant signal (defined by standard PLC program)**

M41~M44: spindle automatic gear shifting output signals. It supports 4-gear spindle automatic gear shifting control when the system selects the spindle analog value control(0~10V analog voltage output)

M41I,M42I: spindle automatic gear shifting No.1, 2 gear in-position signals to support gear shifting in-position check function

- **Signal diagnosis**

Signal	M42I	M41I	M44	M43	M42	M41
Diagnosis address	X1.6	X1.5	Y1.3	Y1.2	Y1.1	Y1.0
Interface pin	CN61.15	CN61.14	CN62.12	CN62.11	CN62.10	CN62.09

- **Signal connection**

The circuit for M41~M44 is shown in Fig.2-47:

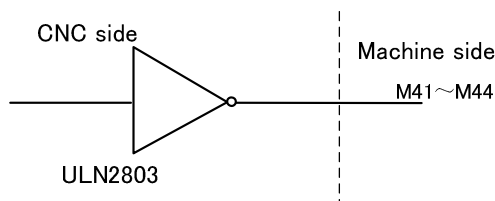

Fig. 2-47

- **Control parameter**

Bit parameter

0	0	1					<b>ACS</b>				
---	---	---	--	--	--	--	------------	--	--	--	--

Bit4 =1: Spindle analog volume control, set to 1 if using spindle automatic gearing

=0: Spindle switching volume control

<b>K</b>	1	5					<b>SHT</b>	<b>AGIM</b>	<b>AGIN</b>	<b>AGER</b>
----------	---	---	--	--	--	--	------------	-------------	-------------	-------------

AGER =1: Spindle automatic gearing active

=0: Spindle automatic gearing inactive

AGIN =1: Detect M41I, M42I signal when shifting to gear 1, 2

=0: Not detect M41I, M42I signal when shifting to gear 1, 2

AGIM =1: Active when M41I, M42I signals disconnecting to +24V

=0: Active when M41I, M42I signals connecting to +24V

SHT =1: spindle gear power-down executes the memory

=0: spindle gear power-down does not execute the memory

Data parameter

0	3	7		<b>GRMAX1</b>
0	3	8		<b>GRMAX2</b>
0	3	9		<b>GRMAX3</b>
0	4	0		<b>GRMAX4</b>

GRMAX1, GRMAX2, GRMAX3, GRMAX4: The respective max. speeds of spindle gear 1, 2, 3, 4 when analog voltage output is 10V. Spindle speeds for M41, M42, M43, M44 when spindle automatic gearing is active.

**0 6 5** SFT1TME

Delay time 1 when automatic gearing signal output, see function description.

**0 6 6** SFT2TME

Delay time 2 when automatic gearing signal output, see function description.

**0 6 7** SFTREV

Output voltage of spindle gearing (0~10000, unit: mV)

**0 6 7** SFTREV

The output voltage during spindle gear shift (0~10000, Unit: mV)

**D T 0 0** SFT1TME

Time for original gear disable during spindle gear shift (ms), refer to function description for details.

**D T 0 1** SFT2TME

Delay time after spindle gear shift (ms), refer to function description for details.

● **Function description (defined by standard PLC program)**

The spindle automatic gearing is active only under the spindle analog voltage control (BIT4 of the bit parameter No.001 set to 1) and the BIT 7 of the bit parameter No.164 is set to 1; if the spindle auto gearing is inactive, alarm will be issued when M41~M44 is being executed and only one of them is active at a time.

When spindle auto gearing is used to control automatic spindle mechanical gear switching, as CNC executes S□□□□ code, it calculates the analog voltage output to spindle servo or frequency inverter based on the parameter of the current gear by M4n (M41~M44 to data parameters No.037~No.040 respectively) to make the actual speed to be consistent with the S code.

When CNC is powered on, the spindle gear memorizing is set by the BIT1 of bit parameter No.168.

If the BIT4 of bit parameter No.001 is 0, the spindle gear is not memorized at repowering after power down, and the gear 1 will be defaulted, M41~M44 are not output. If BIT4 of bit parameter No.001 is 1, the spindle gear is memorized at repowering after power down.

No gearing is done if the specified gear is consistent with the current gear. If not, gearing will be performed, and the process defined by standard ladders is shown in the following:

①Execute any of M41, M42, M43, M44 codes, output analog voltage to spindle servo or frequency inverter according to a value set by data parameter No.067 (Unit: mV);

②After a delay (gearing time 1) by the DT00, turn off the original gear output signal and output the new gearing signal;

③If the gear is 1 or 2, and the BIT6 of the bit parameter No.164 is 1, it jumps to ④, or else it jumps to ⑤;

④Check the gear in-position input signal M41I, M42I, it jumps to ⑤ if the gear in-position is

done; if not, the CNC waits the gear in-position signal;

⑤After a delay (gearing time 2) by DT01, output spindle analog voltage by the current gear according to a value set by data parameter No.037~No.040 (gear 1~4 ) and finish the gearing.

**Note:** The output of M41~M44 is held on when CNC is reset or i emergency stop, which is defined by standard PLC ladder.

### 2.8.7 Spindle eight-point orientation function

● **Related signals (defined by standard PLC program)**

Type	Symbol	Interface	Address	Function	Remark
Input signal	COIN	CN15.8	X5.2	Orientation completion signal	It is valid when 0V is input
	SALM	CN15.4	<b>X5.3</b>	<b>Spindle abnormality alarm signal</b>	
Output signal	STAO	CN62.41	Y3.4	Spindle orientation start signal	
	SP0	CN62.42	Y3.5	Orientation position 0	
	SP1	CN62.43	Y3.6	Orientation position 1	
	SP2	CN62.44	Y3.7	Orientation position 2	
	SFR	CN15.22	Y5.2	Spindle rotation (CW)	
	SRV	CN15.23	<b>Y5.3</b>	Spindle rotation (CCW)	

**Note 1:** STAO signal and the rotation CCW signal of the 2<sup>nd</sup> spindle M64 are multiplexed by the interface, so, eight-point orientation function is invalid when the multiple spindle function is valid.

**Note 2:** STAO, SP0, SP1, SP2 signal and macro output #1102 ~ #1105 are multiplexed by the interface, so, #1102 ~ #1105 is invalid when the eight-point orientation function is valid.

● **Command format**

M51~M58: spindle orientation command

M50 : cancel spindle orientation command

M50~M58 corresponding to the orientation output are shown below:

Output signal Programming command	SP2 (Y3.7)	SP1 (Y3.6)	SP0 (Y3.5)	STAO (Y3.4)
M50	*	*	*	0
M51	0	0	0	1
M52	0	0	1	1
M53	0	1	0	1
M54	0	1	1	1
M55	1	0	0	1
M56	1	0	1	1
M57	1	1	0	1
M58	1	1	1	1

**Note:** When M50 is executed, STAO output is disabled, SP0, SP1, SP2 output continues.

● **Control parameter**

K	1	5				SPOR				
---	---	---	--	--	--	------	--	--	--	--

SPOR =1: The spindle eight-orientation function is valid.

=0: The spindle eight-orientation function is invalid.

K	1	7				SALM				
---	---	---	--	--	--	------	--	--	--	--

SALM =1: The system alarms when the spindle abnormality check input signal is LOW (it is not connected with 0V) .

=0: The system alarms when the spindle abnormality check input signal is HIGH (it is connected with 0V) .

● **Functional description(standard PLC program definition)**

1. After the positioning function commands M51~M58 are executed, PLC→Drive executes the orientation selection signal SP0, SP1, SP2 to confirm the orientation position.

2. Delay 40ms, PLC→Drive executes the spindle orientation start signal STAO; (after the system delays 100ms, the spindle rotation(CW/CCW) is disabled, at the same time, the system starts to check the orientation completion signal (COIN) .

3. Drive unit starts the orientation.

4. After the drive unit orientation is completed, Drive →PLC outputs the spindle completion signal COIN;

5. After PLC receives the spindle orientation completion signal COIN, the spindle orientation is completed, but the spindle orientation signal STAO keeps the output.

6. When M51~M58 is input again, the spindle oriented to another position.

7. After the orientation is completed and when M50 is executed or the spindle orientation is operated, PLC closes the spindle orientation signal STAO output and the drive unit cancels the positioning function.

8. When the system has not received the orientation completion signal after the PLC sends the orientation completion signal for 10000ms, it alarms “the spindle orientation time being long”.

9. Before the orientation, the spindle can rotate or stop; the spindle stops after the orientation.

**Note 1: The drive is for the spindle servo drive unit.**

**Note 2: When the function is selected, the spindle servo drive unit is matched and is valid in the external speed control mode.**

● **Orientation sequence drawing**

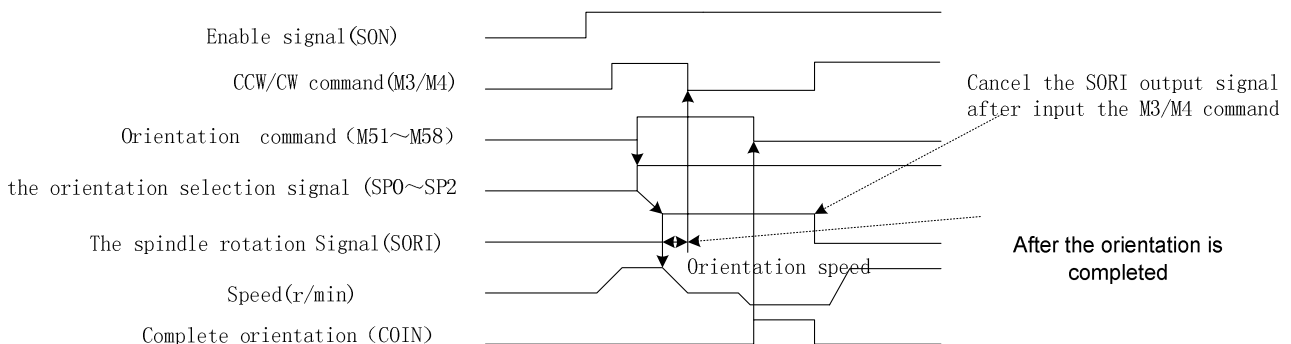

● **Orientation function wiring diagram between GSK980TDC and DAP03**

GSK980TDC signal interface

DAP03 signal interface



### 2.8.8 Spindle Cs axis control function

● Related signals (defined by standard PLC program)

Type	Symbol	Interface	Address	Function	Remark
Input signal	VPO	CN15.5	X5.0	Spindle speed/position control state	It is valid when 0V is input
	ALM5	CN15.4	X5.3	Alarm signal of the 5th drive unit	
Output signal	VP	CN15.20	Y5.0	Spindle speed/position control switch output	
	TAP	CN15.21	Y5.1	The 2nd gain selection signal of the spindle speed(used to the rigid tapping)	
	SFR	CN15.22	Y5.2	Spindle rotation CW	
	SRV	CN15.23	Y5.3	Spindle rotation CCW	

● Command format

M14: The spindle is switched from the speed control mode into the position

M15: The spindle is switched from the position control mode into the speed

**Note:** When the spindle is rotary, Cs function is valid and the corresponding spindle servo drive unit is speed/position switch working mode, the spindle speed/position control switch is valid.

● Control parameters

State parameters

0	0	1					<b>Analog spindle</b>				
---	---	---	--	--	--	--	-----------------------	--	--	--	--

Bit4 =1: Spindle speed analog control. When the spindle automatic gear change function is used, it must be set to 1;  
 =0: Spindle speed switch control.

1	8	7			<b>RCSY</b>					<b>ROSY</b>	<b>ROTY</b>
---	---	---	--	--	-------------	--	--	--	--	-------------	-------------

Bit5 =1: Cs function of Y axis is valid/invalid(power-on again);  
 =0: Cs function of Y axis is valid/invalid(power-on again).  
 Bit 1, Bit0: 00 sets Y to be the linear axis; 01 sets Y to be the rotary axis(A type); 11 sets Y to be the rotary axis(B type); 10 sets Y to be invalid.

1	8	9			<b>RCS4</b>					<b>ROS4</b>	<b>ROT4</b>
---	---	---	--	--	-------------	--	--	--	--	-------------	-------------

Bit5 =1: Cs function of the 4<sup>th</sup> axis is valid/invalid(power-on again);  
 =0: Cs function of the 4<sup>th</sup> axis is valid/invalid(power-on again).  
 Bit 1, Bit0: 00 sets the 4<sup>th</sup> to be the linear axis; 01 sets the 4<sup>th</sup> to be the rotary axis(A type); 11 sets the 4<sup>th</sup> to be the rotary axis(B type); 10 sets the 4<sup>th</sup> to be invalid.

1	9	1			<b>RCS5</b>					<b>ROS5</b>	<b>ROT5</b>
---	---	---	--	--	-------------	--	--	--	--	-------------	-------------

Bit5 =1: Cs function of the 5<sup>th</sup> axis is valid/invalid(power-on again);



=0: Cs function of the 5<sup>th</sup> axis is valid/invalid(power-on again).

Bit 1, Bit0: 00 sets the 5<sup>th</sup> to be the linear axis; 01 sets the 5<sup>th</sup> to be the rotary axis(A type); 11 sets the 5<sup>th</sup> to be the rotary axis(B type); 10 sets the 5<sup>th</sup> to be invalid.

<b>K</b>	<b>1</b>	<b>5</b>	<b>RCS</b>	<b>RSCS</b>						
----------	----------	----------	------------	-------------	--	--	--	--	--	--

RCS =1: Cs function of the spindle is valid.

=0: Cs function of the spindle is invalid.

RSCS =1: The spindle contour control is disabled in emergency stop, reset.

=0: The spindle contour control is enabled in emergency stop, reset.

**Note: K15.7 sets whether all Cs functions are valid, Neo187.5, Neo189.5, Neo191.5 set whether Cs functions of the special axis is valid. When the multiple spindle function is valid, Cs function of only one axis is valid.**

● **Function description (defined by standard PLC program)**

1. Control logic

1) After M14 is executed, PLC→Drive outputs the spindle speed/position control mode switch signal;

2) Drive unit starts the switch control mode. After the switch is completed, Drive→PLC outputs the speed/position switch state signal VPO;

3) After the PLC receives the spindle speed/position switch state signal VPO, the spindle contour control switch signal CON is set to 1. After the system has checked CNC spindle contour control switch end signal FSCSL, M14 execution is ended. The spindle control mode switch is ended.

2. M15 execute processes are the same those of M14.

3.  on the panel is equal to the spindle speed/position control mode switch in Manual

mode. In Manual/MPG mode, press  and the CNC starts the spindle speed/position control mode switch. After the CNC is switched into the spindle position control mode, the spindle orientation

indicator is ON, at the time, Cs position movement is performed. Press  again and the CNC is switched into the spindle speed control mode and the spindle orientation indicator is OFF. (For

980TDc-V, it is  key on the panel)

4. Before switch, the spindle can rotate or stop. After switch, the spindle stops.

5. When the spindle is in Cs contour control mode, the spindle rotation(CW/CCW) output is invalid.

6. When the spindle is in the external speed control mode, the manual operation of Cs axis is invalid.

7. When the alarm occurs in the servo or because of the too long switch time or the reset or emergency stop appears in switch, PLC switches the spindle into the speed control state.

8. When PLC K15.6 is set to 1, the spindle contour control is disabled in emergency stop, reset. PLC switches the spindle into the speed control state.

- Connection diagram between GSK980TDc and DAP03 (taking example of Cs of the 5<sup>th</sup> axis)

GSK980TDc signal interface

DAP03 signal interface

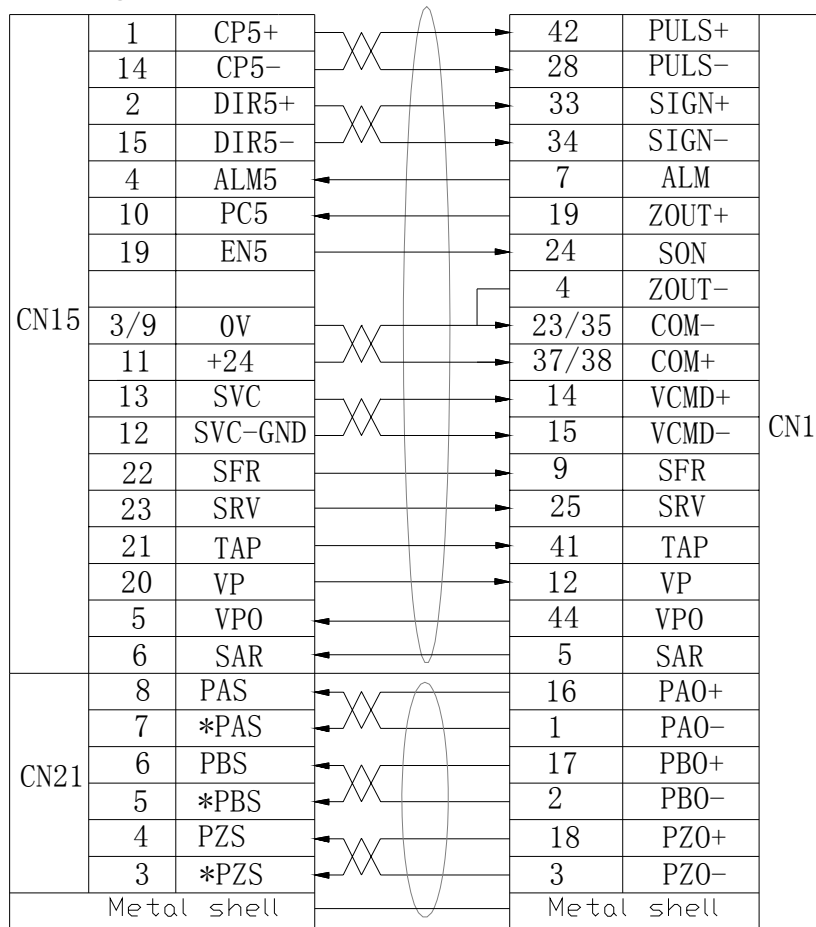

- Wiring diagram between GSK980TDc and GS3000Y-N spindle servo unit (the 5<sup>th</sup> axis is Cs axis in the following example)

GSK980TDc signal interface

GS3000Y-N signal interface

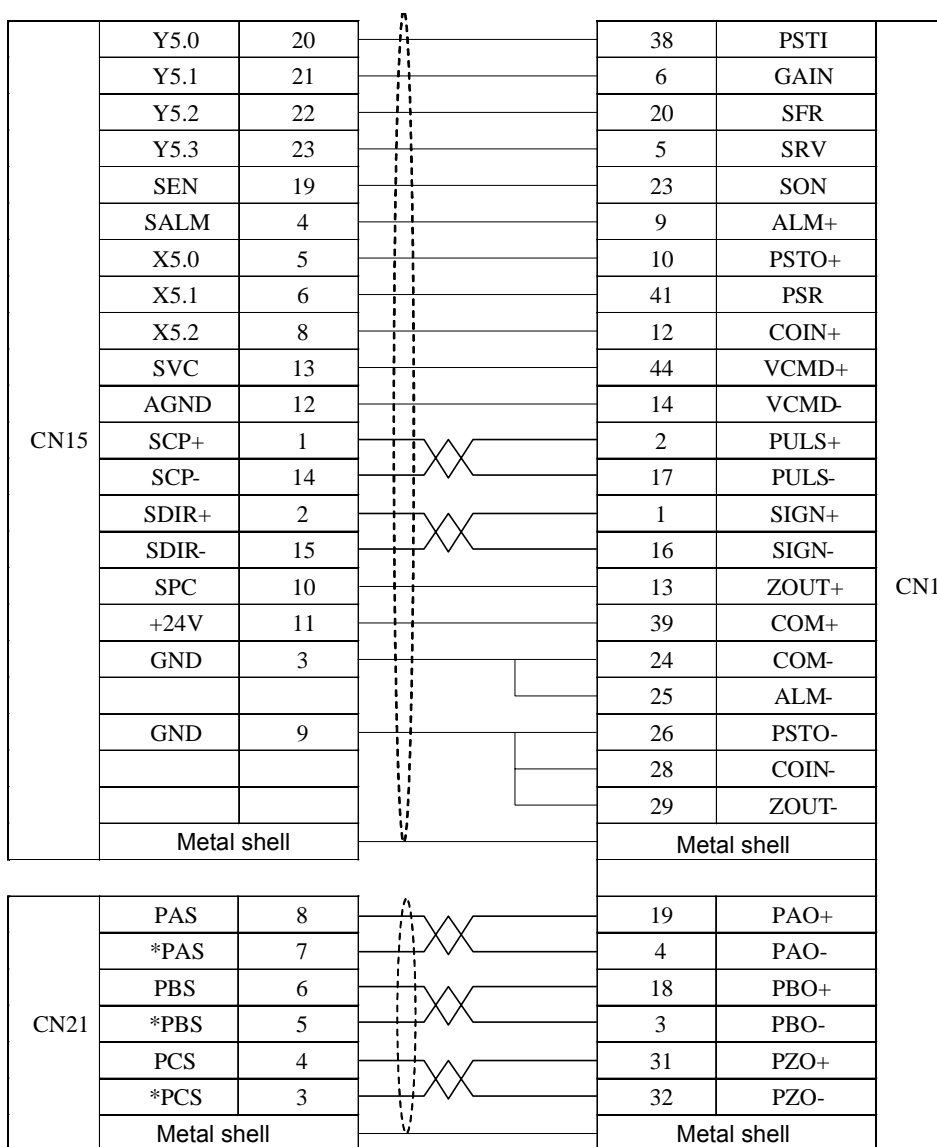

**Note 1:** CN15 signal interface on GSK980TDc side adopts DB25 2-stripe male plug, CN21 adopts DB15 2-stripe female plug.

**Note 2:** GS3000 Series signal interface CN1 adopts DB44 3-stripe male plug.

### 2.8.9 Multiple spindle function

When the multiple spindle function is valid, related signals, parameters and commands are consistent with related explanations of the spindle control, the 1<sup>st</sup>, the 2<sup>nd</sup> spindle explanations are shown below.

- **Related signals (defined by PLC program)**

Type	Symbol	Interface	Address	Function	Remark
Input signal	VPO2	CN61.40	X3.3	The 2 <sup>nd</sup> spindle speed/position control state	Multiplex with the chuck in-position signal
	SALM2	CN61.41	X3.4	<b>The 2nd spindle abnormality alarm signal</b>	
Output signal	VP2	CN62.36	Y2.7	The 2 <sup>nd</sup> spindle speed/ position control switch output	
	TAP2	CN62.39	Y3.2	The 2 <sup>nd</sup> gain selection signal of the 2 <sup>nd</sup> spindle speed loop (used to rigid tapping)	
	M63	CN62.40	Y3.3	The 2 <sup>nd</sup> spindle rotation(CW)	
	M64	CN62.41	Y3.4	The 2 <sup>nd</sup> spindle rotation(CCW)	

**Note 1:** TAP2, M63, M64 and macro output #1100 ~ #1102 are multiplexed by the interface, so #1100 ~ #1102 are invalid when the multiple spindle function is valid.

**Note 2:** SALM2, VPO2 and the chuck in-position signals NQPJ, WQPJ are multiplexed by the interface, so, the system does not check the chuck in-position signal.

● **Command format**

M63 the 2<sup>nd</sup> spindle rotates (CW)

M64 the 2<sup>nd</sup> spindle rotates (CCW)

M65 the 2<sup>nd</sup> spindle stops

M24 the 2<sup>nd</sup> spindle is switched from the speed control mode into the position control mode

M25 the 2<sup>nd</sup> spindle is switched from the position control mode into the speed control mode. The speed control mode is defaulted after the system is turned on.

**Note:** Only the 4<sup>th</sup> is rotary axis and Cs function of the 4<sup>th</sup> is valid, at the same time, the corresponding spindle servo drive unit is in speed/position switch working mode, the switch between the speed control and the position control of the 2<sup>nd</sup> spindle is valid.

● **Control parameters**

1	8	9			RCS4					ROS4	ROT4
---	---	---	--	--	------	--	--	--	--	------	------

Bit5 =1: Cs function of the 4<sup>th</sup> axis is valid/invalid(power-on again);

=0: Cs function of the 4<sup>th</sup> axis is valid/invalid(power-on again).

Bit 1, Bit0: 00 sets the 4<sup>th</sup> to be the linear axis; 01 sets the 4<sup>th</sup> to be the rotary axis(A type); 11 sets the 4<sup>th</sup> to be the rotary axis(B type); 10 sets the 4<sup>th</sup> to be invalid.

1	9	6	MSI	CSS		MSEN					
---	---	---	-----	-----	--	------	--	--	--	--	--

Bit7 1: The multiple spindle control B type;

0: The multiple spindle control A type.

Bit6 1: In the multiple spindle control, the system separately controls Cs contour of each spindle;

0: In the multiple spindle control, the system controls the Cs contour of only the 1<sup>st</sup> spindle.

Bit4 1: The multiple spindle control function is valid;

0: The multiple spindle control function is invalid;

<b>K</b>	<b>1</b>	<b>5</b>	<b>RCS</b>	<b>RSCS</b>						
----------	----------	----------	------------	-------------	--	--	--	--	--	--

RCS =1: The spindle Cs function is valid;

=0: The spindle Cs function is invalid.

RSCS =1: The spindle contour control is disabled in emergency stop, reset;

=0: The spindle contour control is enabled in emergency stop, reset.

<b>K</b>	<b>1</b>	<b>7</b>	<b>MSEN</b>		<b>SALM2</b>					
----------	----------	----------	-------------	--	--------------	--	--	--	--	--

MSEN =1: The multiple spindle control function is valid;

=0: The multiple spindle control function is invalid.

SALM2 =1: The system alarms when the check input signal of the 2<sup>nd</sup> spindle abnormality is LOW;

=0: The system alarms when the check input signal of the 2<sup>nd</sup> spindle abnormality is HIGH;

### Function description(defined by the standard PLC program)

1.1. After the multiple spindle control function setting is valid, the system defaults to the 1<sup>st</sup> spindle control after power-on;

1.2. When M03, M04, M05 is executed, the corresponding signal of the 1<sup>st</sup> spindle outputs, at that time, the system sets the 1<sup>st</sup> spindle control, hereafter, the S command being executed will change the 1<sup>st</sup> spindle speed. In a similar way, M63, M64, M65 is executed, the corresponding signal of the 2<sup>nd</sup> spindle outputs, at the time, the corresponding signal of the 2<sup>nd</sup> spindle outputs, and is switched into the 2<sup>nd</sup> spindle control, after that, the executed S command will change the 2<sup>nd</sup> spindle speed.

1.3. The spindle switch is invalid in rigid tapping.

1.4. The manual CW, CCW, STOP, SPINDLE OVERRIDE keys on the panel are valid only to the 1<sup>st</sup> spindle. When the current system is controlled by the 2<sup>nd</sup> spindle, the manual control key of the spindle on the panel still controls the 1<sup>st</sup> spindle.

1.5. The spindle override of the 2<sup>nd</sup> spindle is fixed to 100%.

1.6. Cs axis control of two spindles can be separately switched and the current used spindle has no requirements, that is, when the current is the 1<sup>st</sup>(2<sup>nd</sup>) spindle, the 2<sup>nd</sup> (1<sup>st</sup>) spindle executes the Cs switch.

#### ● Cs control logic of the 2<sup>nd</sup> spindle



1.1. After M24 is execute, PLC→Drive sends the 2<sup>nd</sup> spindle speed/position control mode switch signal VP2;

1.2 Drive unit starts the switch control mode. After the switch is completed, Drive→PLC outputs the speed/position switch state signal VPO2;

1.3. After the PLC receives the spindle speed/position switch state signal VPO2, the 2<sup>nd</sup> spindle contour control switch signal CON(G127.7) is set to 1. After the system has checked the 2<sup>nd</sup> spindle contour control switch end signal FSCSL(F144.1), M24 execution is ended. The spindle control mode switch is ended.

2. M25 execute processes are the same those of M24.

3. M25 only cancels M24 executing the speed/position switch. Executing M25 cannot switch the system into the speed control mode when executing M29 switches the spindle into Cs contour control.

4.  on the panel is only used to Cs switch of the 1<sup>st</sup> spindle. (For 980TDc-V, it is  key on the panel)

5. Before switch, the spindle can rotate or stop. After switch, the spindle stops.

6. When the spindle is in Cs contour control mode, the spindle rotation(CW/CCW) output is invalid.
7. When the spindle is in the external speed control mode, the manual operation of Cs axis is invalid.
8. When the alarm occurs in the servo or because of the too long switch time or the reset or emergency stop appears in switch, PLC switches the spindle into the speed control state.
9. When PLC K15.6 is set to 1, the spindle contour control is disabled in emergency stop, reset. PLC switches the spindle into the speed control state.
10. When PLC K17.7 is set to 1, the multiple spindle function is enabled, and the system does not check the chuck in-position signal.

● Connection diagram between the 2<sup>nd</sup> spindle and DAP03

GSK980TDc signal interface

DAP03 signal interface

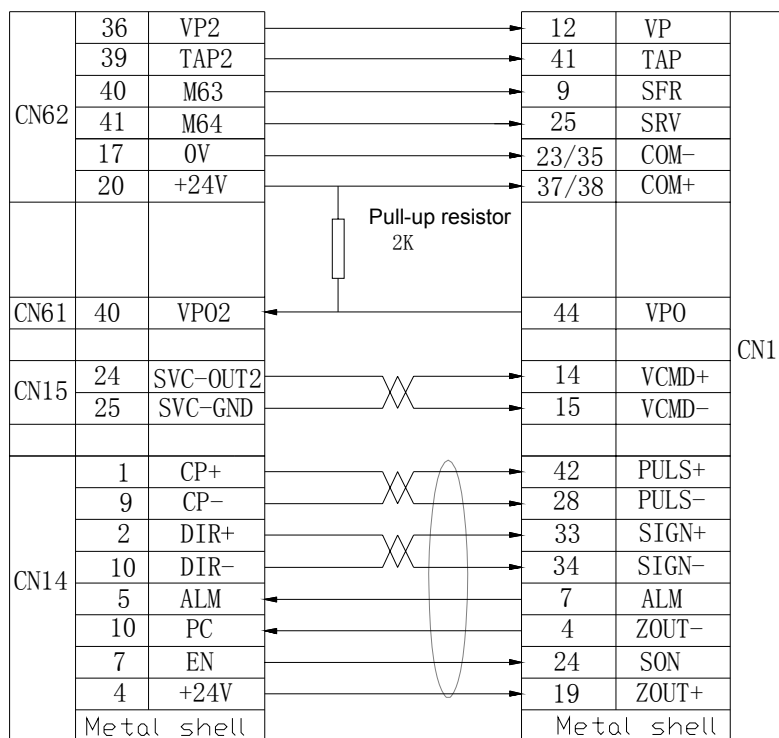

● Connection diagram between the 2<sup>nd</sup> spindle and GS3000Y-N spindle servo unit

GSK980TDc signal interface

GS3000Y-N signal interface

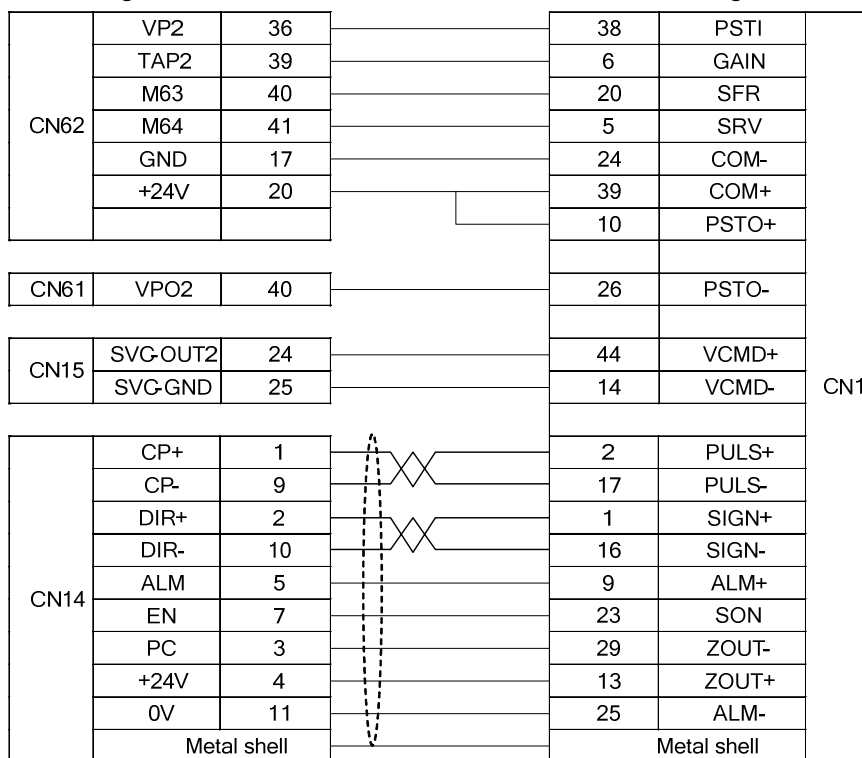

Note: CN1 on GS3000Y-N Series adopts DB44 3-stripe male plug;

2.8.10 Rigid tapping function

● Related commands

- M20 spindle clamped output
- M21 spindle clamped/released output
- M29 entering rigid tapping state

**Note:** When only the selected spindle used to the rigid tapping interpolation is the rotary axis, the rigid tapping function can be executed.

● **Function description (defined by the standard PLC program)**

- ① When the Cs function of the tapping spindle is invalid, the system is switched into the rigid tapping state instead of switching the spindle servo speed/position in executing M29, defaults the spindle servo to be the position control state.
- ② When Cs function of the tapping spindle is enabled, the spindle servo for the tapping is switched into the position control state and the system is switched into Cs contour control state.
- ③ Before M29 switch, the tapping spindle is permitted to the spindle mode or Cs contour control mode. After the rigid tapping return, the tapping spindle returns to the previous control mode.
- ④ When the system is in the rigid tapping state, the manual movement tapping spindle cannot be performed.
- ⑤ The rigid tapping state is cancelled in reset or emergency stop.
- ⑥ In M29, when the 1<sup>st</sup> or the 2<sup>nd</sup> spindle is currently used, it is switched into the rigid tapping state. In rigid tapping, a spindle should be selected firstly to execute the rigid tapping interpolation. After the spindle is switched into the rigid tapping state, the spindle switch is invalid.
- ⑦ After M29 is execute, M20 and the tapping command in the same block are executed to clamp the spindle before drilling or tapping.

**2.8.11 External cycle start and feed hold**

● **Relevant signal (defined by standard PLC program)**

ST: External cycle start signal, whose function is the same with the CYCLE START key on the machine panel;

SP: External feed hold signal, whose function is the same with the FEED HOLD key on the machine panel, and it shares an interface with SAGT(safety door detect) signal.

● **Signal diagnosis**

Signal	SP	ST
Diagnosis address	X0.1	X1.4
Interface pin	CN61.2	CN61.13

● **Signal connection**

The interior circuit of SP/ST signal is shown in Fig. 2-48:

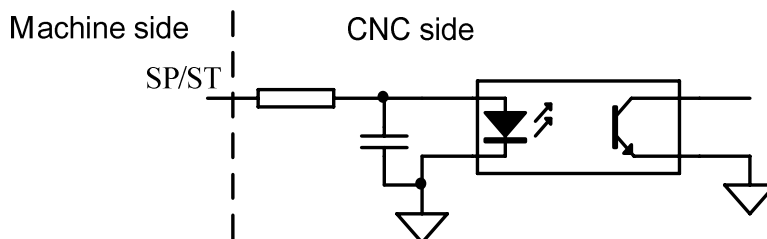

Fig. 2-48

● **Control parameter**

Bit parameter

1	7	2		MST	MSP				
---	---	---	--	-----	-----	--	--	--	--

Bit 6 =1: External cycle start signal (ST) is invalid;



- =0: External cycle start signal (ST) is valid;
- Bit 5 =1: External stop signal (SP) is invalid;
- =0: External stop signal (ST) is valid; the external feed hold switch is needed, otherwise, "Feed hold" is displayed.

● **External connection circuit**

The external connection circuit of SP, ST signals is shown in Fig. 2-49:

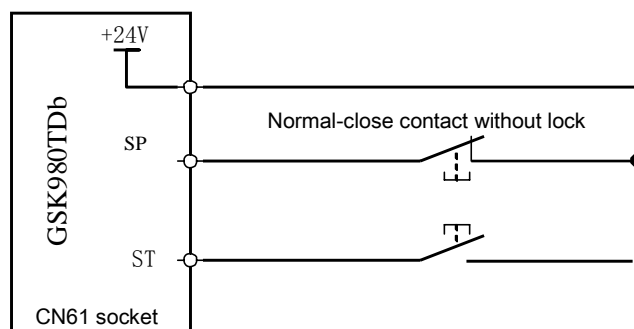

Fig. 2-49

**2.8.12 Cooling control**

● **Relevant signal (defined by standard PLC program)**

Type	Symbol	Interface	Address	Function	Remark
Output signal	M08	CN62.1	Y0.0	Cooling control output	
Command format	M08			Cooling ON	
	M09			Cooling OFF	

● **Signal connection**

Its internal circuit is shown in Fig. 2-50:

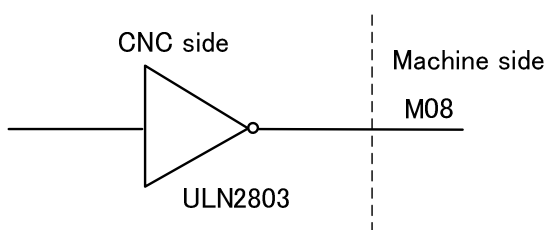

Fig. 2-50 M08 internal circuit

● **Function description (defined by standard PLC program)**

M09 is active, i.e. M08 is inactive, after CNC power on. To execute M08, M08 output is active and cooling is turned on; to execute M09, M08 output is cancelled and cooling is turned off.

**Note 1:** M08 output is cancelled at CNC emergency stop.

**Note 2:** Whether M08 is cancelled is set by BIT3 of the bit parameter No.009 when CNC is reset.

When Bit1=0, M08 output is cancelled as CNC is reset;

When Bit1=1, M08 output is not cancelled as CNC is reset;

**Note 3:** There is no corresponding output signal for M09, and M08 output is cancelled if M09 is executed.

**Note 4:** The cooling can be controlled by the  key on operation panel, see details in OPERATION.



pressing , and is cancelled when the output exceeds the one set by DT13. After the system executes M32, the lubricating output is executed within the time set by DT13 and it is cancelled. Execute M33 in the time set by No. 112 and the output is cancelled.

### 2. Automatic lubricating

When K16.2 is set to 1, the system executes the lubricating in the time set by DT17, and then stops the output. After it keeps the stop in the time set by DT16, it executes the lubricating again repetitively, and executes the cycle in turn. In automatic lubricating, M32, M33,  on the machine panel are valid, and the lubricating time is the one set by DT17.

**Note 1:** The lubricating output is disabled in emergency stop;

**Note 2:** K No.0.10 Bit1 sets whether the lubricating output is cancelled in reset:

Bit1 = 0: the lubricating output is disabled in reset;

Bit1 = 1: the lubricating output remains unchanged in reset.

### 2.8.14 Chuck control

- **Relevant signal (defined by standard PLC program)**

DIQP: Chuck control input signal

DOQPJ: Inner chuck clamping output/outer chuck releasing output signal

DOQPS: Inner chuck releasing output/outer chuck clamping output signal

NQPJ: Inner chuck clamping in-position/outer chuck releasing in-position signal, sharing a common interface with T08, M42I

WQPJ: Inner chuck releasing in-position/outer chuck clamping in-position signal, sharing a common interface with T07, M41I



**Note 1:** The key  on the operation panel of GSK980TDC-V can replace DIQP input signal, and the

diagnosis address is X0026.6.

**Note 2:** NQPJ, WQPJ with the 2<sup>nd</sup> spindle signals SALM2, VPO2 multiplex interface, so, the system does not check the chuck in-position signal when the multi-spindle function is valid.

- **Signal diagnosis**

Signal	DIQP	NQPJ	WQPJ	DOQPJ	DOQPS
<b>Diagnosis address</b>	X0.2	X3.4	X3.3	Y1.4	Y1.5
<b>Interface pin</b>	CN61.3	CN61.40	CN61.41	CN62.13	CN62.14

- **Control parameter**

<b>K</b>	<b>1</b>	<b>2</b>				<b>RCKC</b>	<b>CCHU</b>	<b>NYQP</b>	<b>SLSP</b>	<b>SLQP</b>
----------	----------	----------	--	--	--	-------------	-------------	-------------	-------------	-------------

SLQP =1: Chuck control function is active;

= 0: Chuck control function is inactive;

SLSP =1: Check chuck clamping when the chuck function is active;

0: Does not check chuck clamping when the chuck function is active; if chuck is not clamping, the spindle is disabled and an alarm is issued.

- NYQP =1: Outer chuck mode; NQPJ is outer chuck releasing signal, WQPJ is outer chuck clamping signal  
=0: Inner chuck mode; NQPJ is inner chuck clamping signal, WQPJ is inner chuck releasing signal
- CCHU =1: Check chuck in-position signal.  
=0: Does not check chuck in-position signal.
- RCKC =1: External chuck control is active during program running;  
=0: External chuck control is inactive during program running;

**D T 1 4**

Chuck clamping command (M12) execution time (ms)

**D T 1 5**

Chuck released command (M13) execution time (ms)

**DT0018**

- DT18 >0: Chuck clamping and releasing signals are pulse output, the pulse width is set by DT18  
=0: Chuck clamping and releasing signals are level output

● **Signal connection**

The circuit of DOQPJ/DOQPS is shown in Fig. 2-52:

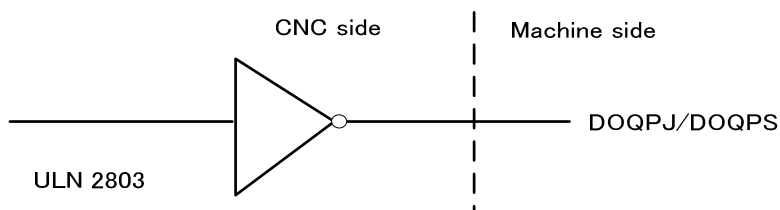

Fig. 2-52

● **Sequence**

①When SLQP=1, SLSP=0, NYQP=0, CCHU=1, CNC chooses inner chuck mode, and chuck in-position signal detecting is active:

DOQPS: chuck releasing output; WQPJ: releasing in-position signal;

DOQPJ: chuck clamping output; NQPJ: clamping in-position signal.

DOQPJ and DOQPS output high resistance at power on, when CNC detects that the chuck input signal DIQP is active for the 1<sup>st</sup> time, DOQPJ is connected to 0V and chuck is clamped.

After M12 is executed, DOQPS (pin 14 of CN62) outputs high resistance, DOQPJ(pin 13 of CN62) outputs 0V, chuck is clamped and CNC waits for NQPJ signal to be in-position.

After M13 is executed, DOQPJ (pin 13 of CN62) outputs high resistance, DOQPS(pin 14 of CN62) outputs 0V, chuck is released and CNC waits for WQPJ signal to be in-position.

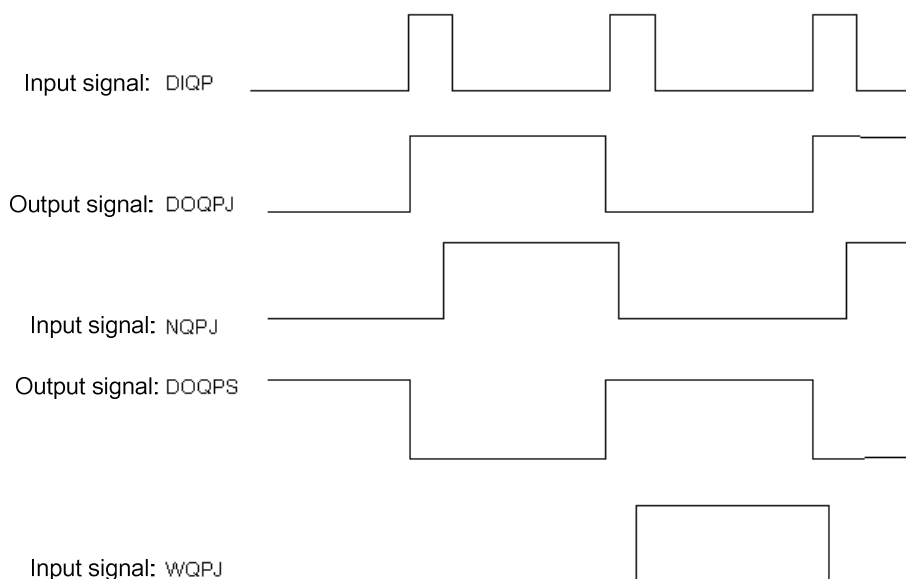

Fig. 2-53 (Chuck clamping, releasing signals are level output)

②When SLQP=1, SLSP=0, NYQP=1, CCHU=1, CNC chooses outer chuck mode, and chuck in-position signal detecting is active:

DOQPS: chuck clamping output; WQPJ: clamping in-position signal;  
DOQPJ: chuck releasing output; NQPJ: releasing in-position signal.

DOQPJ and DOQPS output high resistance at power on, when CNC detects that the chuck input signal DIQP is active for the 1<sup>st</sup> time, DOQPS is connected to 0V and chuck is clamped.

After M12 is executed, DOQPS (CN62.14) outputs 0V, DOQPJ(CN62.13) outputs high resistance, chuck is clamped and CNC waits for WQPJ signal to be in-position.

After M13 is executed, DOQPJ (CN62.13) outputs 0V, DOQPS(CN62.14) outputs high resistance, chuck is released and CNC waits for NQPJ signal to be in-position.

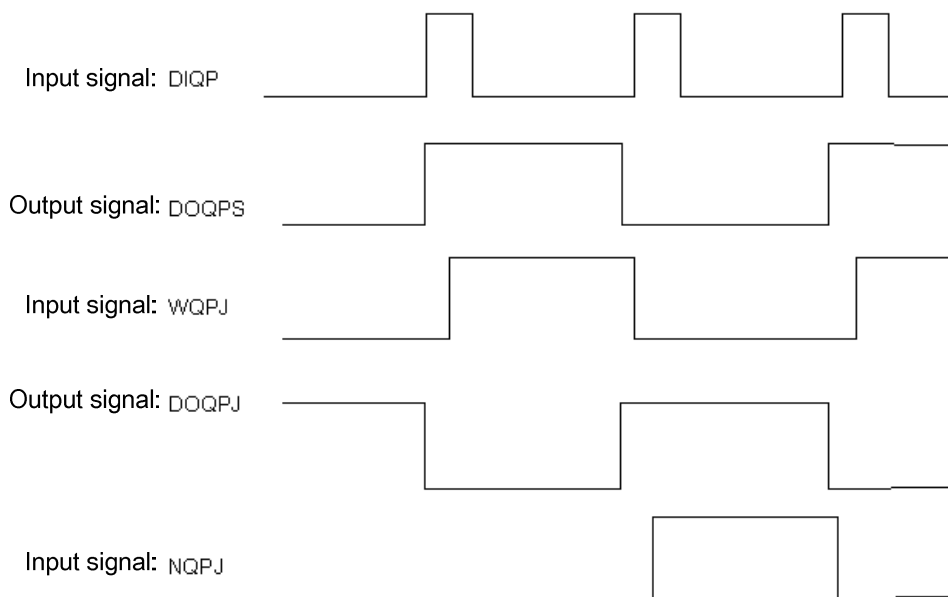

Fig. 2-54 Chuck clamping, releasing signals are level output

As the 2<sup>nd</sup> chuck input is active, DOQPS outputs 0V, chuck is released. The chuck clamping/releasing signal is output alternatively, i.e. the output is changed each chuck input signal is

active.

③The interlock between the chuck and the spindle

When SLQP=1, SLSP=0, M3 or M4 is active, the alarm is issued if M13 is executed and the output is unchanged.

When SLQP=1, SLSP=0, CCHU=1, if M12 is executed in MDI or Auto mode, CNC does not execute next code till it detects the chuck clamping in-position signal is active. When the chuck input signal DIQP is active in Manual mode, the panel spindle CW, CCW key are inactive till it detects the chuck clamping in-position signal is active. In spindle running or auto cycle processing, DIQP input signal is inactive. And DOQPS, DOQPJ is held on at CNC reset and emergency stop.

2.8.15 Tailstock control

● Relevant signal (defined by standard PLC program)

DOTWJ: Tailstock forward output signal

DOTWS: Tailstock backward output signal

DITW: Tailstock input signal, DITW and BDT share a common interface.



Note: For GSK980TDC-V,  can replace DITW input signal, and the diagnosis address is X0026.5.

● Signal diagnosis

Signal	DITW	DOTWJ	DOTWS
Diagnosis address	X0.4	Y2.5	Y2.6
Interface pin	CN61.5	CN61.34	CN61.35

● Control parameter

State parameter

K	1	3							SPTW	SLTW
---	---	---	--	--	--	--	--	--	------	------

SLTW =1: Tailstock function active.

=0: Tailstock function inactive.

SPTW =1: No interlock between spindle rotation and tailstock advancing and retracting, tailstock may be moved regardless of the spindle, or spindle may run regardless of tailstock;

=0: Interlock between spindle rotation and tailstock advancing and retracting, tailstock retraction disabled as spindle is running, spindle disabled if tailstock does not advance.

● Signal connection

The tailstock circuit is shown in Fig. 2-55:

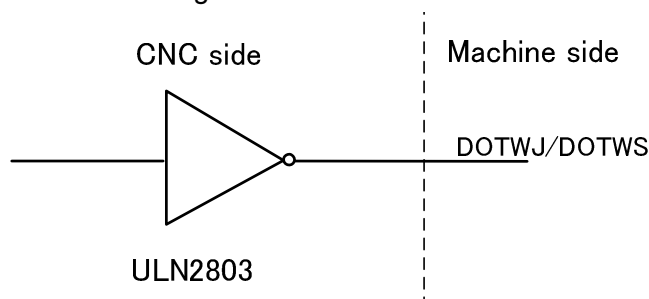

Fig. 2-55

● Sequence (defined by standard PLC program)

The sequence of tailstock is shown in Fig. 2-56:

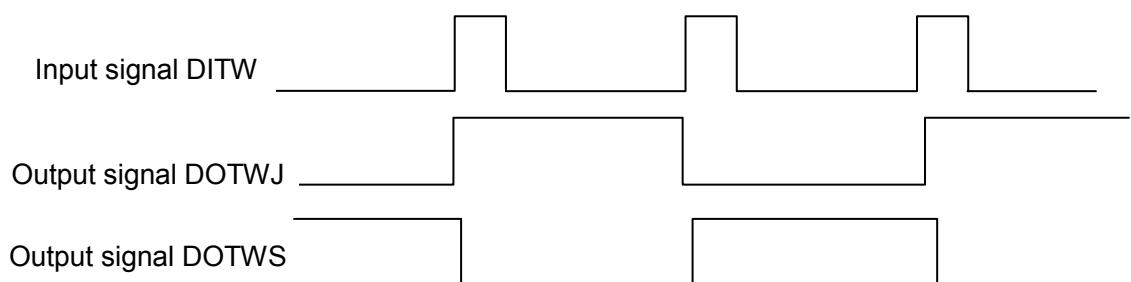

Fig. 2-56 Tailstock sequence

Tailstock advancing (DOTWJ) and retracting(DOTWS) are both inactive when power on; when the tailstock input (DITW) is active for the 1<sup>st</sup> time, tailstock advancing is active; when it is active for the 2nd time, tailstock retracting is active, so the DOTWJ/ DOTWS signal interlock is output alternatively, i.e. The output changes each time the DITW signal is active. If M10 is executed, DOTWJ (CN62.34) outputs 0V and tailstock advances; if M11 is executed, DOTWS (CN62.35) outputs 0V and tailstock retracts.

DITW signal is inactive as spindle is running. If M11 is executed, alarm will be issued, and its output are held on. And DOTWS, DOTWJ outputs are held on at CNC reset or emergency stop.

### 2.8.16 Low pressure detection

- **Relevant signal (defined by standard PLC program)**

PRES: Low pressure alarm detection signal, sharing a common interface with TCP.

- **Signal diagnosis**

<b>Signal</b>	PRES
<b>Diagnosis address</b>	X0.6
<b>Interface pin</b>	CN61.7

- **Control parameters**

State parameter

<b>K</b>	<b>1</b>	<b>4</b>							<b>SPB3</b>	<b>PB3</b>
----------	----------	----------	--	--	--	--	--	--	-------------	------------

PB3 =0: Low pressure detection inactive.

=1: Low pressure detection active.

SPB3 =0: Low pressure alarm issued when PRES is connected with +24V.

=1: Low pressure alarm issued when PRES is connected with 0V.

PLC data parameter

<b>D</b>	<b>T</b>	<b>0</b>	<b>2</b>							<b>PEALMTIM</b>
----------	----------	----------	----------	--	--	--	--	--	--	-----------------

PEALMTIM: Waiting time before low pressure alarm(0~60000ms)

- **Function description**

①When PB3=1 and SPB3=0, PRES is connected to +24V, which is confirmed to be low pressure alarm by CNC;

②When PB3=1 and SPB3=1, PRES is connected to 0V, which is confirmed to be low pressure alarm by CNC;

③When low pressure alarm detection function is selected, once CNC detects the low pressure alarm signal PRES to be active, and the signal holding time is over the setting by the data parameter No.069 alarm is issued by CNC. And the axis feed is held, spindle is stopped, cycle start is disabled,

the alarm may be cancelled by pressing  key or cutting off power;

### 2.8.17 Hydraulic control (only applied to 980TDC-V)

- **Related signal (defined by the standard PLC program)**

EXHP: external hydraulic control input signal  
 HPST: hydraulic control output signal

Note: The EXHP input signal can be replaced by key  on the operation panel; the diagnosis address is X0026.4;

- **Signal diagnosis**

Signal	HPST
<b>Diagnosis address</b>	Y3.1
<b>Interface pin</b>	CN62.38



- **Control parameter**

PLC state parameter

K	1	4	HPST						
---	---	---	------	--	--	--	--	--	--

PB3 =0: the hydraulic control function is disabled.  
 =1: the hydraulic control function is enabled.

- **Function description**

- ① When the hydraulic control function is enabled, pressing  can control HPST output to start the hydraulic motor.
- ② In non-run, the spindle stop with the speed 0, pressing  can disable HPST output.
- ③ When the hydraulic control function enables and the hydraulic motor is started, the system alarm, at the time, the spindle cannot rotate.

### 2.8.18 Safety door detection

- **Relevant signal**

SAGT: For safety door detection, sharing a common interface with SP signal

- **Signal diagnosis**

Signal	SAGT
<b>Diagnosis address</b>	X0.0
<b>Interface pin</b>	CN61.1

- **Control parameter**

- **PLC status parameters**

K	1	4				<b>SGSP</b>	<b>SPB4</b>	<b>PB4</b>		
---	---	---	--	--	--	-------------	-------------	------------	--	--

PB4 =0: Protection door detection function is invalid;  
 =1: Protection door detection function is valid;



- SPB4 =0: When SAGT is at low level (disconnect with +24V), the protection door is closed;  
 =1: When SAGT is at high level (connected with +24V), the protection door is closed;  
 SGSP =0: Spindle is disabled when the protection door is open;  
 =1: Spindle is not disabled when the protection door is open;

● **Function description (defined by standard PLC program)**

- ①When PB4=1, SPB4=0, CNC confirms that the safety door is closed as SAGT is connected to 0V;
- ②When PB4=1, SPB4=1, CNC confirms that the safety door is closed as SAGT is connected to +24V;
- ③In Auto mode, if CNC detects the safety door is open, alarm is issued as cycle starts;
- ④In auto running, if CNC detects the safety door is open, the axis feed is held, and alarm is issued by CNC;
- ⑤The safety door detection function is only active in Auto mode;

**2.8.19 CNC macro variables**

● **Relevant signal**

Macro output signal: standard PLC defines 5 macro output interfaces #1100~#1105;

Macro input signal: standard PLC defines 16 macro output interfaces #1000~#1015

● **Signal diagnosis**

Macro variable number	#1105	#1104	#1103	#1102	#1101	#1100
Diagnosis address	Y3.7	Y3.6	Y3.5	Y3.4	Y3.3	Y3.2

Macro variable number	#1007	#1006	#1005	#1004	#1003	#1002	#1001	#1000
Diagnosis address	X0.7	X0.6	X0.5	X0.4	X0.3	X0.2	X0.1	X0.0

Macro variable number	#1015	#1014	#1013	#1012	#1011	#1010	#1009	#1008
Diagnosis address	X1.7	X1.6	X1.5	X1.4	X1.3	X1.2	X1.1	X1.0

● **Function description (defined by standard PLC program)**

U00~U05 signal output may be changed if macro variable #1100~#1105 are assigned. If they are assigned for “1”, it outputs 0V, if they are assigned for “0”, it turns off their output signals.

Detect the macro variable #1000~#1015 values (input signal state), they may be used for various processing if combined with other transfer judgment macro code.

**2.8.20 External override**

● **Related signals**

Type	Symbol	Interface	Address	Function	Remark
Input signal	OV1	CN61.8	X0.7	External override 1	The external feedrate override switch and the tool signals T5~T8 are multiplexed
	OV2	CN61.9	X1.0	External override 2	
	OV3	CN61.10	X1.1	External override 3	
	OV4	CN61.11	X1.2	External override 4	

● **Related parameters**

PLC state parameter

K	1	6								ROVI	SOVI
---	---	---	--	--	--	--	--	--	--	------	------

ROVI =0: External feedrate override does not inverse.

=1: External feedrate override inverts.

SOVI =0: External feedrate override switch is disabled.

=1: External feedrate override switch is enabled.

● **Function description**

1. When the external feedrate override switch is selected, the button on the panel is disabled.
2. When the external feedrate override switch and the tool signal T5~T8 are multiplexed, and Yantai, Liuxin Tool Post is selected or the total tool count is more than 4, the external feedrate override cannot be selected.
3. When the external feedrate override inverts, the system changes the direction of the override regulation.

**2.8.21 External MPG**

● **Related signals**

CN31(MPG)	PLC address	Address character	Function	Remark
5	X6.0	EHDX	X MPG	Applied toPSG-100-05E/L, ZSSY2080 MPG
6	X6.1	EHDY	Y MPG	
8	X6.2	EHDZ	Z MPG	
9	X6.3	EMP0	Increment ×1	
22	X6.4	EMP1	Increment ×10	
23	X6.5	EMP2	Increment ×100	
11, 12, 13	GND			
14,15	+5V			
17,18	+24V			

● **Related parameters**

State parameter

0	0	1					MPG			
---	---	---	--	--	--	--	-----	--	--	--

Bit3 =0: Step working mode.

=1: MPG working mode.

PLC status parameters

K	1	6	SINC	SINC2						
---	---	---	------	-------	--	--	--	--	--	--

SINC =0: When the system increment is 0.1μ, gear ×1000 in MPG and STEP mode is valid;

=1: When the system increment is 0.1μ, gear ×1000 in MPG and STEP mode is invalid;

SINC2 =0: When the system increment is 1μ, gear ×1000 in MPG and STEP mode is valid;

=1: When the system increment is 1μ, gear ×1000 in MPG and STEP mode is invalid;

● **Function description**

- ① When SINC is set to 0.1, MPG/STEP mode ×1000-gear selection is disabled. When

- x1000-gearis selected before modifying the parameter, the system automatically changes into ×100-gear;
- ② When SINC is set to 1, MPG/STEP mode ×1000-gear selection is disabled. When x1000-gearis selected before modifying the parameter, the system automatically changes into ×100-gear;
- ③ When the external MPG, its axis selection does not lock, that is, the axis selection of MPG is disabled, the system changes to the non-axis selection state.
- ④ When the external MPG axis selection and gear selection input are enabled, the axis selection on the panel and the gear selection keys are disabled; when the external MPG axis selection and gear selection input are disabled, the axis selection on the panel and the gear selection keys are enabled and self-locked.

### 2.8.22 Tri-color Lamp

- **Relevant signals and function definition (standard PLC program)**

Signal type	Symbol	Signal interface	Address	Function
Output signal	CLPY	CN62.31	Y2.2	Yellow— normal state (non-running, non-alarm state)
	CLPG	CN62.32	Y2.3	Green—running state
	CLPR	CN62.33	Y2.4	Red—alarm state

### 2.8.23 Gear/tool number display (only applied to 980TDC-V)

- **Signal diagnosis**

Y0025	BIT7	BIT6	BIT5	BIT4	BIT3	BIT2	BIT1	BIT0
Corresponding BCD code	LED1 2 <sup>3</sup>	LED1 2 <sup>2</sup>	LED1 2 <sup>1</sup>	LED1 2 <sup>0</sup>	LED0 2 <sup>3</sup>	LED0 2 <sup>2</sup>	LED0 2 <sup>1</sup>	LED0 2 <sup>0</sup>

LED 0 displays the current tool number, BIT0~BIT3 of PLC diagnosis number Y25 are BCD code of the current tool number; LED 1 displays the gear of the current spindle, BIT4~BIT7 of PLC diagnosis number Y25 are BCD code of the current spindle gear and is shown below:

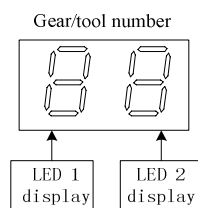

- **Function description**

- ① When the tool count is less than 10, the gear and the tool number separately use one LED to display.
- ② When the tool count is more than 10, LED 1 displays 10-digit numbers and the LED 0 displays the single digits.
- ③ When the gear and the tool number are displayed in time-division, that is, the gear instead of the tool number is firstly display, the tool number instead of the gear is displayed after 1.5S, and the system executes them like the above cycle.

## 2.9 Commonly Use Symbol of Electricity Drawing

GSK980TDc DC24V power supply and the electromagnetic valve with power working current separately use DC24V, and the electronic component explanations are as follows:

Name	Symbol	Graph	Name	Symbol	Graph
Air breaker	QF		Contactory coil contact and auxiliary contact	KM	
transformer	TC		Heat relay and contact	FR	
Rectifier	VC		Capacity	C	
Motor	M		Resistant	R	
Diode	VD		Hall switch		
Electromagnetic coil	YV		Travel switch	SQ	
Relay coil and contact	KA		Veneer socket		
			Pedal switch	SA	
			Fuse	FU	

## CHAPTER 3 PARAMETERS

The CNC bit and data parameters are described in this chapter, various functions can be set by these parameters. The major parameter data type are listed as follows:

	Data type	Range			
(1) Bit	<table border="1" style="display: inline-table; border-collapse: collapse;"> <tr> <td style="padding: 2px 10px;">0001</td> <td style="padding: 2px 10px;">00011000</td> </tr> </table>	0001	00011000	8 bit, 0 or 1	
0001	00011000				
(2) Bit axis	<table border="1" style="display: inline-table; border-collapse: collapse;"> <tr> <td style="padding: 2px 10px;">0187 X</td> <td style="padding: 2px 10px;">00000010</td> </tr> <tr> <td style="padding: 2px 10px;">---- Z</td> <td style="padding: 2px 10px;">00000010</td> </tr> </table>	0187 X	00000010		---- Z
0187 X	00000010				
---- Z	00000010				
(3) Bit spindle					
(4) Word	<table border="1" style="display: inline-table; border-collapse: collapse;"> <tr> <td style="padding: 2px 10px;">0030</td> <td style="padding: 2px 10px;">200</td> </tr> </table>	0030	200	See relevant parameters for details	
0030	200				
(5) Word axis	<table border="1" style="display: inline-table; border-collapse: collapse;"> <tr> <td style="padding: 2px 10px;">0015 X</td> <td style="padding: 2px 10px;">1</td> </tr> <tr> <td style="padding: 2px 10px;">---- Z</td> <td style="padding: 2px 10px;">1</td> </tr> </table>	0015 X	1		---- Z
0015 X	1				
---- Z	1				
(6) Word spindle	<table border="1" style="display: inline-table; border-collapse: collapse;"> <tr> <td style="padding: 2px 10px;">0021 S1</td> <td style="padding: 2px 10px;">0</td> </tr> <tr> <td style="padding: 2px 10px;">---- S2</td> <td style="padding: 2px 10px;">0</td> </tr> </table>	0021 S1	0	---- S2	0
0021 S1	0				
---- S2	0				

**Note:** if the data type is not specified, the type is bit or word.

### 3.1 Parameter Description (by sequence)

#### 3.1.1 Bit parameter

The state parameter is expressed as follows:

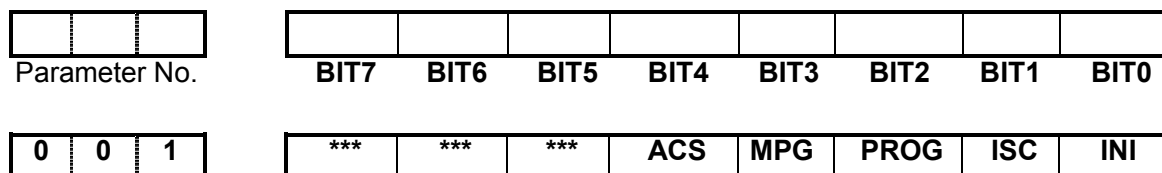

- Bit4 1: Spindle analog voltage control  
0: Spindle switching volume control
- Bit3 1: MPG mode  
0: Step mode
- Bit2 1: Programming by radius  
0: Programming by diameter
- Bit1 1: IS-C incremental system  
0: IS-B incremental system

Increment system	Least input increment, least command increment	Abbreviation
0	0.001mm, 0.0001inch	IS-B
1	0.0001mm, 0.00001inch	IS-C

- Bit0 1: Inch input  
0: Metric input

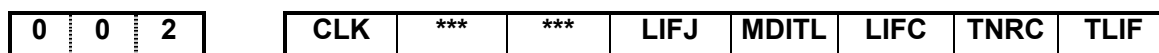

- Bit7 1: Show clock

- 0: Conceal clock
- Bit4 1: Tool life management group skip active  
0: Tool life management group skip inactive
- Bit3 1: Tool life management active in MDI mode  
0: Tool life management inactive in MDI mode
- Bit2 1: Tool life counting type 2, by times  
0: Tool life counting type 1, by times
- Bit1 1: Tool nose radius offset active  
0: Tool nose radius offset inactive
- Bit0 1: Tool life management active  
0: Tool life management inactive

0	0	3	***	***	PCOMP	TCOMP	***	***	***	OIM
---	---	---	-----	-----	-------	-------	-----	-----	-----	-----

- Bit5 1: Pitch error offset active  
0: Pitch error offset inactive
- Bit4 1: Tool offset by coordinate offset  
0: Tool offset by move
- Bit0 1: Offset automatically change in metric and inch conversion  
0: Offset not change in metric and inch conversion

0	0	4	ABOT	RDRN	DECI	ORC	***	***	PROD	SCW
---	---	---	------	------	------	-----	-----	-----	------	-----

- Bit7 1: do not memorize absolute coordinate in power-down  
0: memorize the absolute coordinate in power-down
- Bit6 1: G00 is rapid traverse speed in dry run mode  
0: G00 is manual feedrate in dry run mode
- Bit5 1: DEC signal is high level for machine zero return  
0: DEC signal is low level for machine zero return
- Bit4 1: Tool offset by radius  
0: Tool offset by diameter
- Bit1 1: Relative position for programming in POSITION page  
0: Relative position involving offset in POSITION page
- Bit0 1: Inch system for min. code unit, active after repowering  
0: Metric system for min. code unit, active after repowering

0	0	5	***	***	SMAL	M30	***	POSRE	PPD	PCMD
---	---	---	-----	-----	------	-----	-----	-------	-----	------

- Bit 5 1: Manual spindle gear change during the execution of S code;  
0: Automatic spindle gear change during the execution of S code;
- Bit 4 1: Cursor returns to the head of the program after the execution of M30;  
0: Cursor does not return to the head of the program after the execution of M30;
- Bit 2: 1: Position recording signal PRC is used during tool setting;  
0: Position recording signal PRC is not used during tool setting;
- Bit 1: 1: G50 sets relative coordinate value;  
0: G50 does not set relative coordinate value;
- Bit 0: 1: Axial output wave is pulse;

0: Axial output wave is square;

0	0	6	***	***	***	ZM5	ZM4	ZMY	ZMZ	ZMX
---	---	---	-----	-----	-----	-----	-----	-----	-----	-----

Bit4 1: 5<sup>th</sup> zero return mode C

0: 5<sup>th</sup> zero return mode B

Bit3 1: 4<sup>th</sup> zero return mode C

0: 4<sup>th</sup> zero return mode B

Bit2 1: Y zero return type C

0: Y zero return type B

Bit1 1: Z zero return type C

0: Z zero return type B

Bit0 1: X zero return type C

0: X zero return type B

0	0	7	DISP	***	SMZ	ZC5	ZC4	ZCY	ZCZ	ZCX
---	---	---	------	-----	-----	-----	-----	-----	-----	-----

Bit7 1: Enter ABSOLUTE POS page after power on

0: Enter RELATIVE POS page after power on

Bit5 1: Execute the next block after all motion block exactly are executed to the in-position

0: Smooth transition between two blocks

Bit4 1: In machine zero return, 5<sup>th</sup> deceleration signal (DEC5) and one-revolution signal (PC5) are parallel(use one proximity switch as the deceleration signal and zero signal)

0: In machine zero return, 5<sup>th</sup> deceleration (DEC5) and one-revolution signal (PC5) is separately connected (need the separate deceleration signal and zero signal)

Bit3 1: In machine zero return, 4<sup>th</sup> deceleration signal (DEC4) and one-revolution signal (PC4) are parallel(use one proximity switch as the deceleration signal and zero signal)

0: In machine zero return, 4<sup>th</sup> deceleration (DEC4) and one-revolution signal (PC4) is separately connected (need the separate deceleration signal and zero signal)

Bit2 1: DECY and PCY signals are in parallel (a proximity switch taken as both DECY and zero signals) during machine zero return

0: DECY and PCY signals are separate (separate DECY and zero signals needed) during machine zero return

Bit1 1: DECZ and PCZ signals are in parallel (a proximity switch taken as both DECZ and zero signals) during machine zero return

0: DECZ and PCZ signals are separate (separate DECZ and zero signals needed) during machine zero return

Bit0 1: DECX and PCX signals are in parallel (a proximity switch taken as both DECX and zero signals) during machine zero return

0: DECX and PCX signals are separate (separate DECX and zero signals needed) during machine zero return

0	0	8	***	***	***	DIR5	DIR4	DIRY	DIRZ	DIRX
---	---	---	-----	-----	-----	------	------	------	------	------

Bit4 1: Direction signal (DIR) in 5<sup>th</sup> positive movement is HIGH

0: Direction signal (DIR) in 5<sup>th</sup> negative movement is HIGH

Bit3 1: Direction signal (DIR) in 4<sup>th</sup> positive movement is HIGH

0: Direction signal (DIR) in 4<sup>th</sup> negative movement is HIGH

Bit2 1: Direction signal (DIR) is high level as Y axis moves positively

- 0: Direction signal (DIR) is low level as Y axis moves negatively
- Bit1 1: Direction signal (DIR) is high level as Z axis moves positively
- 0: Direction signal (DIR) is high level as Z axis moves negatively
- Bit0 1: Direction signal (DIR) is high level as X axis moves positively
- 0: Direction signal (DIR) is high level as X axis moves negatively

0	0	9	***	***	***	5ALM	4ALM	YALM	ZALM	XALM
---	---	---	-----	-----	-----	------	------	------	------	------

- Bit4 1: 5<sup>th</sup> alarm signal (ALM5) is LOW alarm
- 0: 5<sup>th</sup> alarm signal (ALM5) is HIGH alarm
- Bit3 1: 4<sup>th</sup> alarm signal (ALM5) is LOW alarm
- 0: 4<sup>th</sup> alarm signal (ALM5) is HIGH alarm
- Bit2 1: Y alarm signal (YALM) is low level alarm
- 0: Y alarm signal (YALM) is high level alarm
- Bit1 1: Z alarm signal (ZALM) is low level alarm
- 0: Z alarm signal (ZALM) is high level alarm
- Bit0 1: X alarm signal (XALM) signal is low level alarm
- 0: X alarm signal (XALM) signal is high level alarm

0	1	0	***	***	***	CPF5	CPF4	CPF3	CPF2	CPF1
---	---	---	-----	-----	-----	------	------	------	------	------

Bit0~ Bit4: Pulse frequency setting values of backlash offset (by BCD code)

The set frequency =(setting value+1) Kpps

CPF5	CPF4	CPF3	CPF2	CPF1	Set frequency (Kpps)
0	0	0	0	0	1
0	0	0	0	1	2
0	0	0	1	0	3
0	0	0	1	1	4
0	0	1	0	0	5
0	0	1	0	1	6
0	0	1	1	0	7
0	0	1	1	1	8
0	1	0	0	0	9
0	1	0	0	1	10
0	1	0	1	0	11
0	1	0	1	1	12
0	1	1	0	0	13
0	1	1	0	1	14
0	1	1	1	0	15
0	1	1	1	1	16
1	0	0	0	0	17
1	0	0	0	1	18
1	0	0	1	0	19
1	0	0	1	1	20
1	0	1	0	0	21
1	0	1	0	1	22



1	0	1	1	0	23
1	0	1	1	1	24
1	1	0	0	0	25
1	1	0	0	1	26
1	1	0	1	0	27
1	1	0	1	1	28
1	1	1	0	0	29
1	1	1	0	1	30
1	1	1	1	0	31
1	1	1	1	1	32

0	1	1	BDEC	BD8	***	***	NORF	ZNIK	***	***
---	---	---	------	-----	-----	-----	------	------	-----	-----

- Bit7 1: Backlash offset type B, the offset data are output by ascending or descending type and the set frequency is inactive;  
0: Backlash offset type A, the offset data are output by the set frequency (by bit parameter No.010) or 1/8 of it.
- Bit6 1: Backlash offset is done by the 1/8 of the set frequency  
0: Backlash offset is done by the set frequency
- Bit3 1: Manual machine zero return inactive  
0: Manual machine zero return active
- Bit2 1: Direction key locked during zero return, homing continues to end by pressing direction key once;  
0: Direction key unlocked, which is held on during zero return

0	1	2	APRS	WSFT	DOFSI	***	EAL	***	EBCL	ISOT
---	---	---	------	------	-------	-----	-----	-----	------	------

- Bit7 1: Automatic ABSOLUTE set after reference return,;  
0: ABSOLUTE not automatically set after reference return
- Bit6 1: Workpiece coordinate offset active, defined by offset No.000  
0: Workpiece coordinate offset inactive
- Bit5 1: Trial tool setting active  
0: Trial tool setting inactive
- Bit3 1: Program editing allowed during CNC alarming  
0: Program editing unallowed during CNC alarming
- Bit1 1: Program end sign EOB displayed for “,”  
0: Program end sign EOB displayed for “\*”
- Bit0 1: Prior to machine zero return after power on, manual rapid traverse active  
0: Prior to machine zero return after power on, manual rapid traverse inactive

0	1	2	APRS	WSFT	DOFSI	***	EAL	***	***	ISOT
---	---	---	------	------	-------	-----	-----	-----	-----	------

- Bit7 1: Automatic ABSOLUTE set after reference return,;  
0: ABSOLUTE not automatically set after reference return
- Bit6 1: Workpiece coordinate offset active, defined by offset No.000  
0: Workpiece coordinate offset inactive
- Bit5 1: Trial tool setting active  
0: Trial tool setting inactive
- Bit3 1: Program editing allowed during CNC alarming

0: Program editing unallowed during CNC alarming

Bit0 1: Prior to machine zero return after power on, manual rapid traverse active

0: Prior to machine zero return after power on, manual rapid traverse inactive

0	1	3	***	***	***	HW5	HW4	HWY	HWZ	HWX
---	---	---	-----	-----	-----	-----	-----	-----	-----	-----

Bit4 1: Coordinates increase in 5<sup>th</sup> MPG (CCW) rotation

0: Coordinates increase in 5<sup>th</sup> MPG (CW) rotation

Bit3 1: Coordinates increase in 4<sup>th</sup> MPG (CCW) rotation

0: Coordinates increase in 4<sup>th</sup> MPG (CW) rotation

Bit2 1: Coordinates increase in Y MPG (CCW) rotation

0: Coordinates increase in Y MPG (CW) rotation

Bit1 1: Coordinates increase in Z MPG (CCW) rotation

0: Coordinates increase in Z MPG (CW) rotation

Bit0 1: Coordinates increase in X MPG (CCW) rotation

0: Coordinates increase in X MPG (CW) rotation

0	1	4	***	***	***	ZRS5	ZRS4	ZRSY	ZRSZ	ZRSX
---	---	---	-----	-----	-----	------	------	------	------	------

Bit 4, Bit3, Bit2, Bit1, Bit0

1: 5th, 4th, Y, Z, X have the machine zeroes. The system needs to check the deceleration signal and zero signal in executing the machine zero return

0: 5th, 4th, Y, Z, X have no machine zeroes. The system does not check the deceleration signal and zero signal till it returns to the zero of machine coordinate in executing the machine zero return

0	1	7	SCRD	***	RSCD	***	TSD	QNI	TSL	TS1
---	---	---	------	-----	------	-----	-----	-----	-----	-----

Bit7 1: Coordinate system is stored before power-off;

0: Coordinate system is not stored before power-off; the default system is set by G54 after power-on;

Bit5 1: Coordinate system is set by G54 after reset;

0: Coordinate system is not changed after reset;

Bit3 1: Movement direction discrimination is valid during offset measurement 4 point input;

0: Movement direction discrimination is invalid during offset measurement 4 point input;

Bit2 1: Tool offset number is set through G signal;

0: Tool offset number is set through the current cursor;

Bit1 1 Tool offset measurement detection signal is valid at low level;

0: Tool offset measurement detection signal is valid at high level;

Bit0 1: Tool offset automatic measurement detection signal 1 point input;

0: Tool offset automatic measurement detection signal 4-point input;

1	7	2	***	MST	MSP	MOT	ESP	***	LZR	***
---	---	---	-----	-----	-----	-----	-----	-----	-----	-----

Bit6 1: External cycle start signal (ST) inactive, it is not the cycle start switch and can be defined by macro code (#1014)

0: External cycle start signal (ST) active

Bit5 1: External SP signal inactive, and it is not the stop switch and can be defined by macro code.( #1015)

0: External SP signal active with external dwell switch needed, otherwise CNC shows

“Stop” [.mailto:M@SP=1](mailto:M@SP=1)

Bit4 1: Not detect software stroke limit

0: Detect software stroke limit

Bit3 1: Emergency stop inactive

0: Emergency stop active

Bit1 1: Software limit is inactive after power-on and before machine zero return;

0: Software limit is active after power-on and before machine zero return;

1	7	4	***	***	***	***	KEY1	***	***	***
---	---	---	-----	-----	-----	-----	------	-----	-----	-----

Bit3 1: Program switch ON at power on

0: Program switch OFF at power on

1	7	5	SPFD	SAR	THDA	VAL5	VAL4	VALY	VALZ	VALX
---	---	---	------	-----	------	------	------	------	------	------

Bit7 1: In cutting feed, do not permit the spindle stopping rotation; the spindle stops, the feed also stops when the system appears No.404 alarm cutting

0: In cutting feed, permit the spindle stops rotation; the spindle stops rotation, but the feed does not stop

Bit6 1: Detect spindle SAR signal prior to cutting

0: Not detect spindle SAR signal prior to cutting

Bit5 1: Thread machining is the exponential acceleration/deceleration

0: Thread machining is the linear acceleration/deceleration



Bit4 1: 5<sup>th</sup> movement key is \_positive, is \_negative



0: 5<sup>th</sup> movement key is \_positive, is \_negative



Bit3 1: 4<sup>th</sup> movement key  is positive,  is negative

0: 4<sup>th</sup> movement key  is positive,  is negative



Bit2 1: Y movement key  is positive,  is negative

0: Y movement key  is positive,  is negative

Bit1 1: movement key  is positive,  is negative

0: Z movement key  is positive,  is negative

Bit0 1: X movement key  is positive,  is negative

0: X movement key  is positive,  is negative

1	8	0	NAT	***	***	***	***	***	***	SPOS
---	---	---	-----	-----	-----	-----	-----	-----	-----	------

Bit7 1: Function ATAN, ASIN range is 90.0~270.0;

0: Function ATAN, ASIN range is -90.0~90.0

Bit0 1: DIS TO GO displayed in POS&PRG page

0: RELATIVE POS displayed in POS&PRG page

1	8	1	RLC	MRC	ZCL	***	MCL	***	***	LCNMD
---	---	---	-----	-----	-----	-----	-----	-----	-----	-------









Bit7 1: G52 local coordinate system is cancelled after reset;

0: G52 local coordinate system is not cancelled after reset;

Bit6 1: G52 local coordinate system is cancelled after the execution of M30, M02;

- 0: G52 local coordinate system is not cancelled after the execution of M30, M02;
- Bit5 1: G52 local coordinate system is cancelled after reference point return;
- 0: G52 local coordinate system is not cancelled after reference point return;
- Bit3 1: Blocks edited in MDI mode are deleted after reset;
- 0: Block edited in MDI mode are not deleted after reset;
- Bit0 1: In linear chamfering, L means the length between chamfering point and cross point;
- 0: In linear chamfering, L means the length of chamfering;

1	8	3	***	***	***	MZR5	MZR4	MZRY	MZRZ	MARX
---	---	---	-----	-----	-----	------	------	------	------	------

- Bit4 1: 5<sup>th</sup> press\_key to execute the machine zero return
- 0: 5th press\_key to execute the machine zero return
- Bit3 1: 4<sup>th</sup> press  to execute the machine zero return
- 0: 4th press  to execute the machine zero return
- Bit2 1: Y press  to execute the machine zero return
- 0: Y press  to execute the machine zero return
- Bit1 1: Z press  to execute the machine zero return
- 0: Z press  to execute the machine zero return
- Bit0 1: X press  to execute the machine zero return
- 0: X press  to execute the machine zero return

1	8	4	***	***	***	***	***	L2	L1	L0
---	---	---	-----	-----	-----	-----	-----	----	----	----

Bit0, Bit1, Bit2: Language selection:

Language	Bit2	Bit1	Bit0
Chinese	0	0	0
English	0	0	1
Portuguese	0	1	0
Spanish	0	1	1
Russian	1	1	0

1	8	5	SK0	SKF	AEO	***	***	***	PRPD	PLA
---	---	---	-----	-----	-----	-----	-----	-----	------	-----

- Bit7 1: Skip input active as G31 signal is 0
- 0: Skip input active as G31 signal is 1
- Bit6 1: Feedrate override per minute or dry run active for G31
- 0: Feedrate override per minute or dry run inactive for G31
- Bit5 1: Input active if G36, G37 (XAE, ZAE) signal is 0
- 0: Input active if G36, G37 (XAE, ZAE) signal is 1
- Bit1 1: Axis rapid traverse rate of PLC by input value
- 0: Axis rapid traverse rate of PLC by parameter value (X axis: No.022; Z axis:No.023; Y axis:No.134)
- Bit0 1: PLC axis control active, active after repowering
- 0: PLC axis control inactive, active after repowering

1	8	6	RTORI	SRS	***	***	***	RTCRG	***	***
---	---	---	-------	-----	-----	-----	-----	-------	-----	-----

- Bit7 1: In executing M29, the spindle executes the machine zero return  
0: In executing M29, the spindle does not execute the machine zero return
- Bit6 1: The spindle selection signal is RGTSPn in the multiple spindle rigid tapping  
0: The spindle selection signal is SWSn in the multiple spindle rigid tapping
- Bit2 1: In rigid tapping cancel, do not wait for G61.0 to be 0 in executing the next block  
0: In rigid tapping cancel, wait for G61.0 to be 0 in executing the next block

1	8	7	YIS1Y	Y IS0	RCSY	***	***	***	ROSY	ROTY
---	---	---	-------	-------	------	-----	-----	-----	------	------

- BIT7,BIT6: Set Y incremental system,  
00: consistent with the incremental system of the system,  
01: IS-A, 10: IS-B; 11: IS-C.
- Bit5 1: Y Cs function is valid/invalid(power-on again)  
0: Y Cs function is valid/invalid(power-on again)
- Bit1,Bit0 : 00 : sets Y to be linear,  
01 : sets Y to be rotary axis(A type),  
11 : sets Y to be rotary axis(B type),  
10: sets Y to be invalid

1	8	7	YIS1Y	Y IS0	RCSY	***	***	***	ROSY	ROTY
---	---	---	-------	-------	------	-----	-----	-----	------	------

[Data type]: Bit axis

BIT7, BIT6: Set the increment system of all axes;

00: Same with the original increment system; 01: IS-A; 10: IS-B; 11: IS-C;

Bit5 1: Cs function of auxiliary axis is enabled (needs to re-power on)

0: Cs function of auxiliary axis is not enabled (needs to re-power on)

Bit1, Bit0: 00: Set auxiliary axis as linear axis; 01: Set auxiliary axis as rotary axis (A type); 11: Set auxiliary axis as rotary axis (B type); 10: Auxiliary axis is disabled;

**Note: This parameter is invalid to X, Z axes.**

1	8	8	***	RRTY	***	***	***	RRLY	RABY	ROAY
---	---	---	-----	------	-----	-----	-----	------	------	------

[Data type]: Bit axis

- Bit6 1: When Y is the rotary axis, the zero return uses D mode  
0: When Y is the rotary axis, the zero return uses A, B, C mode
- Bit2 1: When Y is the rotary axis, the relative coordinate cycle function is valid  
0: When Y is the rotary axis, the relative coordinate cycle function is invalid
- Bit1 1: Y rotates according to the symbol when it is the rotary axis  
0: Y rotates contiguously when it is the rotary axis
- Bit0 1: The absolute coordinate cycle function is valid when Y is the rotary axis  
0: The absolute coordinate cycle function is valid when Y is the rotary axis

1	9	6	MSI	CSS	***	MSEN	***	***	***	***
---	---	---	-----	-----	-----	------	-----	-----	-----	-----

Bit7 1: The multiple spindle control B  
0: The multiple spindle control A

Bit6 1: Cs control of each axis is executed in the multiple spindle control

0: Cs control of only the 1<sup>st</sup> spindle is executed in the multiple spindle control

Bit4 1: The multiple spindle control is enabled

0: The multiple spindle control is disabled

2	0	3	***	***	***	ABP5	ABP4	ABPY	ABPZ	ABPX
---	---	---	-----	-----	-----	------	------	------	------	------

Bit4 1: 5<sup>th</sup> pulse outputs based on the two-phase quadrature

0: 5<sup>th</sup> pulse outputs based on (pulse+direction)

Bit3 1: 4<sup>th</sup> pulse outputs based on the two-phase quadrature

0: 4<sup>th</sup> pulse outputs based on (pulse+direction)

Bit2 1: Y pulse outputs based on the two-phase quadrature

0: Y pulse outputs based on (pulse+direction)

Bit1 1: Z pulse outputs based on the two-phase quadrature

0: Z pulse outputs based on (pulse+direction)

Bit0 1: X pulse outputs based on the two-phase quadrature

0: X pulse outputs based on (pulse+direction)

### 3.1.2 Data parameter

0	1	5	CMRn
---	---	---	------

[Data type] Word axis

[Data meaning] Pulse frequency multiplication coefficient

[Data range] 1~32767

0	1	6	CMDn
---	---	---	------

[Data type] Word axis

[Data meaning] Pulse frequency division coefficient;

[Data range] 1~32767

Explanation: Formula of electric gear ratio:  $\frac{CMR}{CMD} = \frac{4 * C * \delta}{L} * \frac{Z_M}{Z_D}$

Δ: Least command increment;

Z<sub>M</sub>: Teeth number of pulley on leading screw side;

C: Motor encoder line number;

Z<sub>D</sub>: Teeth number of pulley on motor side;

L: Screw lead

0	1	9	THDCH
---	---	---	-------

[Data meaning] Run-out length in threading

[Data range] 0~225

Thread run-out width= THDCH×0.1×screw lead

0	2	1	PSANGNT
---	---	---	---------

[Data type] Word spindle

[Data meaning] Voltage offset value when spindle max. speed analog voltage output is 10V

[Data unit] mV

[Data range] -2000~2000(Unit: mV)

0	2	2	RPDFn
---	---	---	-------

[Data type] Word axis

[Data meaning] Maximum rapid traverse rate of all axes  
 [Data unit]

Setting unit	Data unit
Metric machine	mm/min
Inch machine	0.1inch/min

[Data range] 10~99999999

**0 2 3**

**RPDFZ**

[Data type] Word axis

[Data meaning] Acceleration/deceleration time constant during rapid traverse

[Data unit]

Setting unit	Data unit
Metric machine	mm/min
Inch machine	0.1inch/min

[Data range] 0~4000

**0 2 6**

**THRDT**

[Data meaning] ACC&DEC time constant of short axis in thread run-out

[Data unit] ms

[Data range] 0~4000

**0 2 7**

**FEDMX**

Data meaning] Upper limits of X, Z feedrate

[Data unit]

Setting unit	Data unit
Metric machine	mm/min
Inch machine	0.1inch/min

[Data range]

	IS-B	IS-C
Metric machine	10~15000	10~15000
Inch machine	5~5800	10~5800

**0 2 8**

**THDFL**

[Data meaning] X, Z initial speed in threading (mm/min)

[Data unit]

Setting unit	Data unit
Metric machine	mm/min
Inch machine	0.1inch/min

[Data range]

	IS-B	IS-C
Metric machine	6~8000	6~8000
Inch machine	3~3000	3~3000

0 2 9

**FEEDT**

[Data meaning] Exponential ACC&DEC time constant of cutting and manual feed  
 [Data unit] ms  
 [Data range] 0~4000

0 3 0

**FEDFL**

[Data meaning] Exponential acceleration start speed and deceleration end speed in cutting feed  
 [Data unit]

Setting unit	Data unit
Metric machine	mm/min
Inch machine	0.1inch/min

[Data range]

	IS-B	IS-C
Metric machine	0~8000	0~8000
Inch machine	0~3000	0~3000

0 3 1

**JOGSPEED**

[Data meaning] the set speed when the manual feedrate override is 100%  
 [Data unit]

Setting unit	Data unit
Metric machine	mm/min
Inch machine	0.1inch/min

[Data range] 10~30000

0 3 2

**RPDFL**

[Data type] Word axis  
 [Data meaning] Rapid traverse rate as axis rapid override is F0  
 [Data unit]

Setting unit	Data unit
Metric machine	mm/min
Inch machine	0.1inch/min

[Data range]

	IS-B	IS-C
Metric machine	0~4000	0~4000
Inch machine	0~1500	0~1500

0 3 3

**ZRNFL**

[Data type] Word axis  
 [Data meaning] Low rate as axes return to machine zero  
 [Data unit]



Setting unit	Data unit
Metric machine	mm/min
Inch machine	0.1inch/min

[Data range] 6~4000

**0 3 4**

**BKLX**

[Data type]

Word axis

[Data meaning]

BKLX (X) ,BKLZ (Z) backlash compensation

[Data unit]

Setting unit	IS-B	IS-C
Metric machine	0.001 mm	0.0001 mm
Inch machine	0.0001 inch	0.00001 inch

[Data range] 0~2000

**Note : X is the diameter value.**

**0 3 6**

**SPDLC**

[Data type]

Word spindle

[Data meaning]

Voltage offset for 0V analog voltage output of spindle min. speed code

[Data unit]

mV

[Data range]

-1000~1000

**0 3 7**  
**0 3 8**  
**0 3 9**  
**0 4 0**

**GRMAX1**  
**GRMAX2**  
**GRMAX3**  
**GRMAX4**

[Data meaning]

GRMAX1, GRMAX2, GRMAX3, GRMAX4: Max. speeds of gear 1, 2, 3, 4 respectively when spindle analog voltage output is 10V (the function defined by GSK980TDc PLC is: if the spindle automatic gearing is active, it uses the speeds of M41, M42, M43, M44; if the automatic gearing is inactive or CNC is powered on, the gear is memorized by parameter or the gear 1 is defaulted.)

[Data unit]

r/min

[Data range]

10~9999

**0 4 1**

**JOGFL**

[Data meaning]

Exponential ac-deceleration start speed and deceleration final speed in manual feed

[Data unit]

Setting unit	Data unit
Metric machine	mm/min
Inch machine	0.1inch/min

[Data range]

0~8000

**0 4 2**

**SEQINC**

[Data meaning]

Block No. increment for auto block No. insertion

[Data range] 1~100

0 4 3

LOWSP

[Data meaning] (G96) Spindle min. speed under the constant surface speed control

[Data unit] r/min

[Data range] 0~9999

0 4 4

BRATE0

[Data meaning] Serial communication baud rate,

[Data unit] bit/s

[Data range] 1200,2400,4800,9600,19200,38400 57600 115200

0 4 5

LT1X1

0 4 6

LT1Z1

[Data type] Word axis

[Data meaning] LT1X1 (X) ,LT1Z1 (Z) positive max. travel, LT1X2 (X) ,LT1Z2 (Z) negative max. travel

[Data unit]

Setting unit	IS-B	IS-C
Metric machine	0.001 mm	0.0001 mm
Inch machine	0.0001 inch	0.00001 inch

[Data range] -99999999~99999999

**Note:** If the BIT2 of the parameter No.001 is set for diameter, the X axis value is specified by diameter; if for radius, the X axis value is specified by radius.

0 4 7

PRSn

[Data type] Word axis

[Data meaning] Setting value of absolute coordinate after machine zero return

[Data unit]

Setting unit	IS-B	IS-C
Metric input	0.001 mm	0.0001 mm
Inch input	0.0001 inch	0.00001 inch

[Data range] -99999999~99999999

0 5 1

MRCCD

[Data meaning] Each feeding for G71, G72 rough turning cycle, which may also be changed by program code in auto running.

[Data unit]

Setting unit	IS-B	IS-C
Metric input	0.001 mm	0.0001 mm
Inch input	0.0001 inch	0.00001 inch

[Data range]

	IS-B	IS-C

Metric input	1~99999	1~999999
Inch input	1~99999	1~999999

0	5	2
---	---	---

[Data meaning]

[Data unit]

[Data range]

**MRCDT**

Each retraction for G71, G72 rough turning cycle, which may also be changed by program code in auto running.

Setting unit	IS-B	IS-C
Metric input	0.001 mm	0.0001 mm
Inch input	0.0001 inch	0.00001 inch

0~99999

0	5	3
---	---	---

[Data meaning]

[Data unit]

[Data range]

**PECSCX0**

X axis rough turning retraction in G73, which may also be changed by program code in auto running.

Setting unit	IS-B	IS-C
Metric input	0.001 mm	0.0001 mm
Inch input	0.0001 inch	0.00001 inch

-9999999~9999999

0	5	4
---	---	---

[Data meaning]

[Data unit]

[Data range]

**PECSCZ**

Z axis rough turning retraction in G73, which may also be changed by program code in auto running

Setting unit	IS-B	IS-C
Metric input	0.001 mm	0.0001 mm
Inch input	0.0001 inch	0.00001 inch

-9999999~9999999

0	5	5
---	---	---

[Data meaning]

[Data unit]

[Data range]

**PATIM**

Cycle times of G73, which may also be changed by program code in auto running

times

1~9999

0	5	6
---	---	---

[Data meaning]

[Data unit]

**GROVE**

Retraction value of Z axis in G74; retraction value of X axis in G75; a specified value in program during automatic running can also change the setting of this parameter;

Setting unit	IS-B	IS-C
Metric input	0.001 mm	0.0001 mm

Inch input	0.0001 inch	0.00001 inch
------------	-------------	--------------

[Data range] 0~99999

**0 5 7**

**THRPT**

[Data meaning] Repetitions of G76 finish machining, which may also be changed by program code in auto running

[Data unit] times

[Data range] 1~99

**0 5 8**

**THANG**

[Data meaning] Tool nose angle of G76 cycle, which may also be changed by program code in auto running

[Data unit] deg

[Data range] 0~99

**0 5 9**

**THCLM**

[Data meaning] Min. cut depth of G76 cycle, which may also be changed by program code in auto running

[Data unit]

Setting unit	IS-B	IS-C
Metric input	0.001 mm	0.0001 mm
Inch input	0.0001 inch	0.00001 inch

[Data range]

	IS-B	IS-C
Metric input	0~99999	0~99999
Inch input	0~99999	0~99999

**0 6 0**

**THDFN**

[Data meaning] Finish allowance of G76, which may also be changed by program code in auto running

[Data unit]

Setting unit	IS-B	IS-C
Metric input	0.001 mm	0.0001 mm
Inch input	0.0001 inch	0.00001 inch

[Data range]

	IS-B	IS-C
Metric input	0~99999	0~99999
Inch input	0~99999	0~99999

**0 6 7**

**SFTREV**

[Data type] Word spindle

[Data meaning] Output voltage of spindle gearing

[Data unit] mV

[Data range] 0~10000

**0 6 8**

**SJOGREV**

[Data type] Word spindle

[Data meaning] spindle speed in manual (MPG) mode

[Data unit] r/min

[Data range] 0~3000

**0 7 0**

**ENCODER\_CNT**

[Data type] Word spindle

[Data meaning] Spindle encoder pulses

[Data unit] line/revolution

[Data range] 100~5000

**0 7 1**

**RESET\_TIME**

[Data meaning] Output time of reset signal

[Data unit] ms

[Data range] 16~4080

**0 7 2**

**SAR\_DELEY**

[Data meaning] Delay detecting time of SAR signal

[Data unit] ms

[Data range] 0~4080

**0 7 3**

**SPMOTORMAX**

[Data type] Word spindle

[Data meaning] Max. spindle motor clamping speed, setting value=(max. spindle motor clamping speed/max. spindle motor speed) ×4095

[Data unit] r/min

[Data range] 0~4095

Setting value = (max. clamp speed of spindle/max. speed of spindle motor) ×4095.

**0 7 4**

**SPMOTORMIN**

[Data meaning] Min. spindle motor clamping speed, setting value=(min. spindle motor clamping speed/max. spindle motor speed) ×4095

[Data unit] r/min

[Data range] 0~4095

Setting value = (min. clamping speed of spindle motor/max. speed of spindle motor) ×4095

**0 7 5**

**SPSPEEDLIMIT**

[Data type] Word spindle

[Data meaning] Maximum spindle rev speed(0~6000r/min)[0:unlimited]

[Data unit] r/min

[Data range] 0~6000

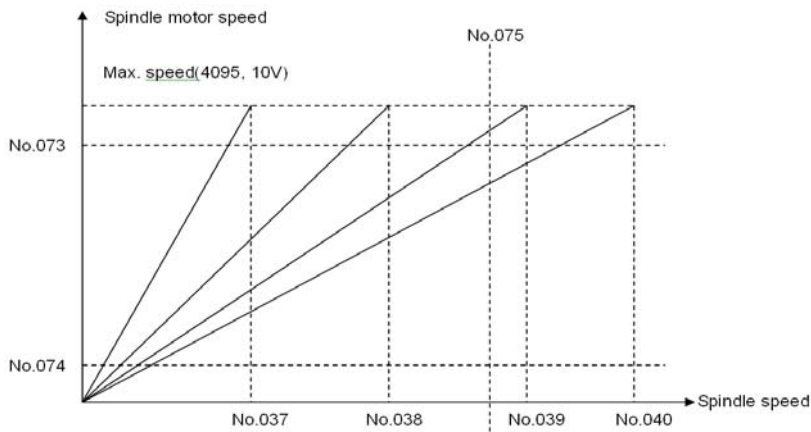

**0 8 4**

**TMAX**

[Data meaning] Total tools number selection

[Data unit] piece

[Data range] 1~32

**0 9 6**

**PECMINn**

[Data type] Word axis

[Data meaning] Minimum pitch error compensation position number

[Data range] 0~1023

**0 9 7**

**PECMAXn**

[Data type] Word axis

[Data meaning] Maximum pitch error compensation position number

[Data range] 0~1023

**0 9 8**

**PECORGn**

[Data type] Word axis

[Data meaning] Pitch error compensation position numbers corresponding to machine zero points

[Data range] 0~1023

**0 9 9**

**PECINTn**

[Data type] Word axis

[Data meaning] Pitch error compensation intervals

[Data unit]

Setting unit	IS-B	IS-C
Metric machine	0.001 mm	0.0001 mm
Inch machine	0.0001 inch	0.00001 inch

[Data range]

	IS-B	IS-C
--	------	------

Metric machine	1000~999999	10000~9999999
Inch machine	400~999999	4000~9999999

**1 0 6****THD\_SPD\_VAR**

[Data meaning]

Spindle fluctuation alarm limit in threading (not detect spindle fluctuation alarm if set to 0)

[Data unit]

%

[Data range]

0~100

Formula= $|\text{current speed} - \text{previous period speed}| \times 200 / (\text{current speed} + \text{previous period speed})$ **1 0 7****THD\_TAIL\_SPD**

[Data meaning]

Short axis speed in threading run-out (run-out by threading feedrate if set to 0)

[Data unit]

Setting unit	Data unit
Metric machine	mm/min
Inch machine	0.1inch/min

[Data range]

0~8000

**1 0 9****SPL\_REV\_SPD**

[Data meaning]

Spindle jog speed (r/min)

[Data unit]

r/min

[Data range]

1~8000

**1 1 0****MGR**

[Data type]

Word spindle

[Data meaning]

Gear ratio of encoder to spindle: spindle gear teeth number

[Data range]

1~255

**1 1 1****SGR**

[Data type]

Word axis

[Data meaning]

Gear ratio of encoder to spindle: encoder gear teeth number

[Data range]

1~255

**1 1 3****REF\_SPD**

[Data type]

Word axis

[Data meaning]

Axes rapid traverse rates in machine zero return

[Data unit]

Setting unit	Data unit
Metric machine	mm/min
Inch machine	0.1inch/min

[Data range]

10~921571875

1 1 4

**REF\_OFFSETX**

[Data type]  
[Data meaning]  
[Data unit]

Word axis  
Offset of X, Z machine zero

Setting unit	IS-B	IS-C
Metric input	0.001 mm	0.0001 mm
Inch input	0.0001 inch	0.00001 inch

[Data range] -99999~99999

1 1 9

**KEY\_P\_NUM**

[Data meaning]  
[Data unit]  
[Data range]

Number of active keys at a time  
piece  
2~5

1 2 0

**REF1\_COORDX**

1 2 1

**REF1\_COORDZ**

1 2 2

**REF2\_COORDX**

1 2 3

**REF2\_COORDZ**

[Data type]  
[Data meaning]

Word axis  
REF1\_COORDn 1st reference point machine coordinates;  
REF2\_COORDn 2<sup>nd</sup> reference point machine coordinates;  
REF3\_COORDn 3<sup>rd</sup> reference point machine coordinates;  
REF4\_COORDn 4<sup>th</sup> reference point machine coordinates [Data unit]

Setting unit	IS-B	IS-C
Metric input	0.001 mm	0.0001 mm
Inch input	0.0001 inch	0.00001 inch

[Data range] -99999999~99999999

1 4 0

**TWEAR\_MAX**

[Data meaning]  
[Data unit]

+ or - limit of each input wear in TOOL OFFSET&WEAR interface

Setting unit	IS-B	IS-C
Metric input	0.001 mm	0.0001 mm
Inch input	0.0001 inch	0.00001 inch

[Data range]

	IS-B	IS-C
Metric input	1~99999	1~999999
Inch input	1~99999	1~999999

1 4 1

**AUTO\_OFFSET\_FEED**

[Data meaning]  
[Data unit]

Feedrate in automatic tool offset measure



Setting unit	Data unit
Metric machine	mm/min
Inch machine	0.1inch/min

[Data range]

	IS-B	IS-C
Metric machine	15~1000	15~1000
Inch machine	7~375	7~375

1	4	2
1	4	3

[Data meaning]

<b>AUTO_OFFSET_Y_X</b>
<b>AUTO_OFFSET_Y_Z</b>

X(AUTO\_OFFSET\_Y\_X),Z(AUTO\_OFFSET\_Y\_Z)y values in automatic tool offset

[Data unit]

Setting unit	IS-B	IS-C
Metric machine	0.001 mm	0.0001 mm
Inch machine	0.0001 inch	0.00001 inch

[Data range]

1~9999999

**Note: X setting value is the radius in diameter or radius programming**

1	4	4
1	4	5

[Data meaning]

<b>AUTO_OFFSET_E_X</b>
<b>AUTO_OFFSET_E_Z</b>

AUTO\_OFFSET\_E\_X(X),AUTO\_OFFSET\_E\_Z(Z)ε values in automatic tool offset

[Data unit]

Setting unit	IS-B	IS-C
Metric machine	0.001 mm	0.0001 mm
Inch machine	0.0001 inch	0.00001 inch

[Data range]

1~9999999

**Note: X setting value is the radius in diameter or radius programming**

1	5	4
---	---	---

[Data meaning]

<b>RADIUS_ERR_RANGE</b>
-------------------------

Max. arc radius error

[Data unit]

Setting unit	IS-B	IS-C
Metric machine	0.001 mm	0.0001 mm
Inch machine	0.0001 inch	0.00001 inch

[Data range]

	IS-B	IS-C
Metric machine	0~1000	0~10000
Inch machine	0~50	0~500

1	6	2
---	---	---

[Data type]

<b>CSACCFL</b>
----------------

Word spindle

[Data meaning] initial speed of CS acceleration/deceleration  
 [Data unit] deg/min  
 [Data range] 0~4000

**1 6 3**

**CSACCTIME**

[Data type] Word spindle  
 [Data meaning] acceleration/deceleration time constant of CS  
 [Data unit] ms  
 [Data range] 0~4000

**1 6 6**

**CAACCFL**

[Data type] Word spindle  
 [Data meaning] initial speed of linear acceleration/deceleration in rigid tapping  
 [Data unit]

Setting unit	Data unit
Metric machine	mm/min
Inch machine	0.1inch/min

[Data range] 0~4000

**1 6 7**

**CAACCTIME**

[Data meaning] linear acceleration/deceleration time constant in rigid tapping tool in-feed  
 [Data unit] ms  
 [Data range] 0~4000

**1 6 9**

**RTAPBACKRATE**

[Data meaning] override value in rigid tapping tool retraction (override is 100% when it is set to 0)  
 [Data unit] %  
 [Data range] 0~200

**1 7 0**

**CMCODE**

[Data meaning] M code used for spindle clamping during rigid tapping  
 [Data unit]  
 [Data range] 3~97

**1 7 1**

**CAMAX\_S**

[Data meaning] max. spindle speed in rigid tapping  
 [Data unit] r/min  
 [Data range] 0~6000

**2 1 6**

**ROT\_REVY**

[Data meaning] Y (ROT\_REVY) ,4th (ROT\_REV4) ,5th (ROT\_REV5) is the movement pre revolution of rotary axis

[Data unit]

Setting unit	IS-B	IS-C
Rotary axis	0.001 deg	0.0001 deg

[Data range] 1000~99999999

**2 1 9****PLCDIDOn**

[Data type] Word axis

[Data meaning] Select DI/DO according to PLC controlled axes (0 means PLC axis control is not applied)

[Data unit]

[Data range] 0~4

**2 2 4****AXISNUM**

[Data meaning] Axis number displayed on the screen

[Data unit]

[Data range] 2~5

**2 2 5****NAME\_Y**

[Data meaning] Axis name definition of Y, 4th, 5th

[Data range] 65,66,67,88, 89, 90

Axis name	Setting value	Axis name	Setting value
A	65	C	67
B	66	Y	89

**2 3 0****ATTRIB\_n**

[Data meaning] ATTRIB\_n is the additional attribution setting

[Data range] 0~7

Setting value	Meaning
0	It is neither the three basic axes and an axis parallel to them
1	X axis of the three basic axes
2	Y axis of the three basic axes
3	Z axis of the three basic axes
5	An axis parallel to X
6	An axis parallel to Y
7	An axis parallel to Z

**2 3 5****POLARLINEAXIS**

[Data meaning] Linear axis setting of the polar coordinate interpolation

[Data range] 0~4

Setting value	Meaning
0	X axis
1	Z axis

2	Y axis
3	4 <sup>th</sup> axis
4	5 <sup>th</sup> axis

**2 3 6**

[Data meaning]

[Data range]

**POLARTOSAXIS**

Rotary axis setting of the polar coordinate interpolation

2~4

Setting value	Meaning
2	Y axis
3	4 <sup>th</sup> axis
4	5 <sup>th</sup> axis

**2 3 7**

[Data meaning]

[Data range]

**ACCEPTANGLEERR**

Maximum fluctuating value when the angle is 0° or 180° for C tool offset C

IS-B	IS-C
0~1000	0~10000

**2 4 0**

[Data meaning]

[Data range]

**HWRPDFRATE**

Rapid traverse override of MPG trial cut function

0~100

**2 4 1**

[Data meaning]

[Data range]

**HWPULSEINC**



Movement amount per pulse during trial cut function

0~100

**3.1.3 PLC parameters (standard PLC definition)**

**3.1.3.1 K parameters**

<b>K 1 0</b>	<b>LMIT</b>	<b>LMIS</b>	<b>***</b>	<b>JSPD</b>	<b>OVRI</b>	<b>***</b>	<b>RSJG</b>	<b>RRW</b>
--------------	-------------	-------------	------------	-------------	-------------	------------	-------------	------------

- Bit7 1: overtravel of each axis is enabled;  
0: overtravel of each axis is disabled.
- Bit6 1: alarm for overtravel signal LOW of each axis;  
0: alarm for overtravel signal LOW of each axis
- Bit4 1: spindle JOG is enabled in any modes;  
0: spindle JOG is enabled in Manual, MPG, Zero Return mode.
- Bit3 1: feedrate override is fixed to 100%;  
0: feedrate override can be adjusted.
- Bit2 1:  on the panel in MDI mode can start the program run;  
0:  on the panel in MDI mode cannot start the program run.
- Bit1 1: spindle lubricating, cooling output remain in reset;  
0: spindle lubricating, cooling output are disabled in reset.

- Bit0 1: the cursor returning to the beginning of the program is enabled in any working mode in reset;  
0: the cursor returning to the beginning of the program is enabled in Edit working mode.

<b>K</b>	<b>1</b>	<b>1</b>	<b>CHOT</b>		<b>CHET</b>	<b>TCPS</b>	<b>CTCP</b>	<b>TSGN</b>	<b>CHTB</b>	<b>CHTA</b>
----------	----------	----------	-------------	--	-------------	-------------	-------------	-------------	-------------	-------------

- Bit7 1: checks the tool post worktable overheating;  
0: does not check the tool post worktable overheating.
- Bit5 1: checks the tool signal when the tool change is completed;  
0: does not check the tool signal when the tool change is completed.
- Bit4 1: tool post locking signal HIGH(be connected with +24V) is enabled;  
0: tool post locking signal LOW(not be connected with +24V) is enabled
- Bit3 1: checks the tool post locking signal;  
0: does not check the tool post locking signal.
- Bit2 1: tool signal LOW(not be connected with +24V) is enabled;  
0: tool signal HIGH(be connected with +24V)is enabled.
- Bit1 Bit0 : tool change mode selects Bit1 tool change mode selects Bit 0

<b>CHTB</b>	<b>CHTA</b>	<b>Tool post type</b>
0	0	Standard tool change mode B
0	1	Standard tool change mode A
1	0	Yantai AK31 series(6, 8, 10, 12 tools)
1	1	Liuxin hydraulic tool post (8, 10, 12 tools)

<b>K</b>	<b>1</b>	<b>2</b>				<b>RCKC</b>	<b>CCHU</b>	<b>NYQP</b>	<b>SLSP</b>	<b>SLQP</b>
----------	----------	----------	--	--	--	-------------	-------------	-------------	-------------	-------------

- Bit4 1: External chuck control is enabled during program running;  
0: External chuck control is disabled during program running
- Bit3 1: the system checks the chuck in-position signal;  
0: the system does not check the chuck in-position signal.
- Bit2 1: in outer mode, NQPJ is the outer chuck released signal, and WQPJ is the outer chuck clamped signal;  
0: in inner mode, NQPJ is the inner chuck clamped signal, and WQPJ is the inner chuck released signal.
- Bit1 1: the system does not check whether the chuck is clamped when the chuck function is enabled;  
0: the system checks whether the chuck is clamped when the chuck function is enabled;  
when the chuck is not clamped, the system cannot start the spindle and alarms.
- Bit0 1: the chuck control function is enabled;  
0: the chuck control function is disabled.

<b>K</b>	<b>1</b>	<b>3</b>						<b>RTSC</b>	<b>SPTW</b>	<b>SLTW</b>
----------	----------	----------	--	--	--	--	--	-------------	-------------	-------------

- Bit2 1: External tailstock control is enabled during program running;  
0: External tailstock control is disabled during program running;
- Bit1 1: the spindle rotation and the tailstock forward/backward does not interlock, the tailstock executes the forward no matter what the spindle is in any states; the spindle rotates no matter what the tailstock is in any states;  
0: the spindle rotation and the tailstock forward/backward interlock, the tailstock cannot

execute the forward when the spindle rotates; the spindle cannot be started when the tailstock does not execute the forward.

- Bit0 1: the tailstock control function is enabled;
- 0: the tailstock control function is disabled.

K	1	4	HPST			SGSP	SPB4	PB4	SPB3	PB3
---	---	---	------	--	--	------	------	-----	------	-----

- Bit7 1: the hydraulic control function is enabled;
- 0: the hydraulic control function is disabled.
- Bit4 1: Spindle is enabled when the protection door is open
- 0: Spindle is disabled when the protection door is open;
- Bit3 1: when SAGT is connected with +24V, the safety door is disabled;
- 0: when SAGT is not connected with +24V, the safety door is disabled.
- Bit2 1: the safety door check function is enabled;
- 0: the safety door check function is disabled.
- Bit1 1: when PRES is not connected with +24V, the system alarms for pressure LOW;
- 0: when PRES is connected with +24V, the system alarms for pressure LOW.
- Bit0 1: the pressure LOW check function is enabled;
- 0: the pressure LOW check function is disabled.

K	1	5	RCS	RSCS	SPOR		SHT	AGIM	AGIN	AGER
---	---	---	-----	------	------	--	-----	------	------	------

- Bit7 1: Cs function is enabled;
- 0: Cs function is disabled.
- Bit6 1: the spindle contour control is disabled in emergency stop, reset;
- 0: the spindle contour control is enabled in emergency stop, reset.
- Bit5 1: the spindle eight-point orientation function is enabled;
- 0: the spindle eight-point orientation function is disabled.
- Bit3 1: the spindle gear power-down memory;
- 0: the spindle gear power-down does not execute the memory.
- Bit2 1: the gear in-position signal M41I, M42I which are not connected with +24V is enabled;
- 0: the gear in-position signal M41I, M42I which are connected with +24V is enabled.
- Bit1 1: when the spindle automatic gear change is to Gear 1, 2, the system checks the gear change in-position signal M41I, M42I;
- 0: when the spindle automatic gear change is to Gear 1, 2, the system does not check the gear change in-position signal M41I, M42I.
- Bit0 1: the spindle automatic gear change function is enabled;
- 0: the spindle automatic gear change function is disabled

K	1	6	SINC	SINC2	SPWM	CLWM		M32A	ROVI	SOVI
---	---	---	------	-------	------	------	--	------	------	------

- Bit7 1: When Step (MPG) mode×1000-gear is disabled,×1, ×10, ×100 gear is enabled;
- 0: When Step (MPG) mode×1000-gear is disabled,×1, ×10, ×100, ×1000 gear is enabled.
- Bit6 1: When the increment is 1u, gear “×1000” in STEP (MPG) mode is disabled;
- 0: When the increment is 1u, gear “×1000” in STEP (MPG) mode is enabled;
- Bit5 1: When spindle stop command is in the same block with movement command, these commands are executed at the same time;
- 0: When spindle stop command is in the same block with movement command, movement

- command comes first to spindle stop command;
- Bit4 1: When cooling OFF command and movement command are in the same block, they are executed at the same time;  
0: When cooling OFF command and movement command are in the same block, movement command comes first to the cooling OFF command;
- Bit2 1: the lubricating outputs in power-on when the automatic lubricating is enabled;  
0: the lubricating does not output in power-on when the automatic lubricating is enabled.
- Bit1 1: the external feedrate override inverses;  
0: the external feedrate override does not inverse.
- Bit0 1: the external feedrate override switch is enabled  
0: the external feedrate override switch is disabled.

<b>K</b>	<b>1</b>	<b>7</b>	<b>MSEN</b>	<b>SCLP</b>	<b>SALM2</b>	<b>SALM</b>	<b>SSTP</b>	<b>SONC</b>		
----------	----------	----------	-------------	-------------	--------------	-------------	-------------	-------------	--	--

- Bit7 1: the multiple spindle control function is enabled;  
0: the multiple spindle control function is disabled.
- Bit6 1: the spindle clamped command clamps the 2<sup>nd</sup> spindle when the multiple spindle is enabled;  
0: the spindle clamped command clamps the 1<sup>st</sup> spindle when the multiple spindle is enabled
- Bit5 1: the system alarms when the 2<sup>nd</sup> spindle is LOW;  
0: the system alarms when the 2<sup>nd</sup> spindle is HIGH.
- Bit4 1: the system alarms when the spindle is LOW;  
0: the system alarms when the spindle is HIGH.
- Bit3 1: the analog voltage is disabled when the spindle stops;  
0: the analog voltage is enabled when the spindle stops.
- Bit2 1: Spindle is disabled when clamping;  
0: Spindle motor torque decreases to 0 when spindle is clamping;

<b>K</b>	<b>1</b>	<b>8</b>					<b>MDOK</b>	<b>MD4</b>	<b>MD2</b>	<b>MD1</b>
----------	----------	----------	--	--	--	--	-------------	------------	------------	------------

- Bit3 1: the operation mode is specified by MD4, MD2, MD1 state when the system is turned on;  
0: the operation mode is the state which is that of power-off when the system is turned on.

MD4	MD2	MD1	Operation mode in power-on
0	0	0	MDI mode
0	0	1	Auto mode
0	1	0	Program zero return
0	1	1	Edit mode
1	0	0	MPG mode
1	0	1	Manual mode
1	1	0	Machine zero return

### 3.1.3.2 DT parameter

Address	Meaning
DT000	Time for original gear disabling during spindle automatic gear changing (ms)
DT001	Delay time after the changed spindle gear is in position (ms)
DT002	Detection time for low pressure alarm (ms)

Address	Meaning
DT004	Permit time for tool changing (ms)
DT005	M command execution time (ms)
DT006	S command execution time (ms)
DT007	Delay time for tool post from CW to CCW output (ms)
DT008	Tool post lock signal detection time (ms)
DT009	Tool post CCW rotation lock time (ms)
DT010	Spindle braking delay output time (ms)
DT011	Spindle braking output time (ms)
DT012	Spindle JOG time (ms)
DT013	Time for manual lubricating ON (0: time is not limited) (ms)
DT014	Chuck clamping command execution time (ms)
DT015	Chuck unclamping command execution time (ms)
DT016	Interval of automatic lubricating (ms) (can be modified directly)
DT017	Time for automatic lubrication output (ms) (can be modified directly)
DT018	Chuck pulse output width (ms) (can be modified directly)
DT020	Spindle clamping/unclamping time (ms)
DT021	Spindle stop, chuck enable delay time (ms)
DT023	Delay time before spindle motor torque decreases to 0 after spindle starts clamping

3.1.3.3 DC parameters

Address	Meaning
DC000	Spindle zero speed output range (r/min)

3.2 Parameter Description (by function sequence)

3.2.1 X, Z, Y, 4<sup>th</sup>, 5<sup>th</sup> axis control logic

0	0	1	***	***	***					ISC	
---	---	---	-----	-----	-----	--	--	--	--	-----	--

Bit1 1: IS-C incremental system;  
 0: IS-B incremental system.

ISC	Least input increment, least command increment	Abbreviation
0	0.001mm,0.0001inch	IS-B
1	0.0001mm,0.00001inch	IS-C

0	0	5										PCMD
---	---	---	--	--	--	--	--	--	--	--	--	------

PCMD =1: CNC output wave is pulse  
 =0: CNC output wave is square

0	0	8				DIR5	DIR4	DIRY	DIRZ	DIRX
---	---	---	--	--	--	------	------	------	------	------



- Bit4 1: Direction signal (DIR) is HIGH when 5<sup>th</sup> positively moves ;  
0: Direction signal (DIR) is HIGH when 5<sup>th</sup> negatively moves.
- Bit3 1: Direction signal (DIR) is HIGH when 4<sup>th</sup> positively moves;  
0: Direction signal (DIR) is HIGH when 4<sup>th</sup> negatively moves.
- Bit2 1: Direction signal (DIR) is HIGH when Y positively moves ;  
0: Direction signal (DIR) is HIGH when Y negatively moves.
- Bit1 1: Direction signal (DIR) is HIGH when Z positively moves;  
0: Direction signal (DIR) is HIGH when Z negatively moves.
- Bit0 1: Direction signal (DIR) is HIGH when X positively moves;  
0: Direction signal (DIR) is HIGH when X negatively moves.

**If machine moving direction is inconsistent with the actually required direction, it may be adjusted by this parameter.**

0	0	9				5ALM	4ALM	YALM	ZALM	XALM
---	---	---	--	--	--	------	------	------	------	------

- Bit4 1: 5<sup>th</sup> alarm signal (ALM5) is LOW alarm;  
0: 5<sup>th</sup> alarm signal (ALM5) is HIGH alarm.
- Bit3 1: 4<sup>th</sup> alarm signal (ALM4) is LOW alarm;  
0: 4<sup>th</sup> alarm signal (ALM4) is HIGH alarm.
- Bit2 1: Y alarm signal (ALMY) is LOW alarm;  
0: Y alarm signal (ALMY) is HIGH alarm.
- Bit1 1: Z alarm signal (ZALM) is LOW alarm;  
0: Z alarm signal (ZALM) is HIGH alarm.
- Bit0 1: X alarm signal (XALM) is LOW alarm;  
0: X alarm signal (XALM) is HIGH alarm.

**This parameter may be adjusted based on the drive unit alarm signal level output.**

1	7	5	SPFD							
---	---	---	------	--	--	--	--	--	--	--

- SPFD =1: Feeding stops if spindle stops in cutting  
=0: Feeding not stop if spindle stops in cutting

1	8	7	YIS1Y	YIS0		***	***	***		
---	---	---	-------	------	--	-----	-----	-----	--	--

[Data type]: Bit axis

BIT7,BIT6: set Y incremental system, 00: consistent with the incremental system of the system, 01: IS-A, 10: IS-B; 11: IS-C.

2	0	3	***	***	***	ABP5	ABP4	ABPY	ABPZ	ABPX
---	---	---	-----	-----	-----	------	------	------	------	------

- Bit4 1: 5<sup>th</sup> pulse outputs according to the two-phase quadrature (need to power-on again);  
0: 5<sup>th</sup> pulse outputs according to (pulse + direction) (need to power-on again).
- Bit3 1: 4<sup>th</sup> pulse outputs according to the two-phase quadrature (need to power-on again);  
0: 4<sup>th</sup> pulse outputs according to (pulse + direction) (need to power-on again).
- Bit2 1: Y pulse outputs according to the two-phase quadrature (need to power-on again);  
0: Y pulse outputs according to (pulse + direction) (need to power-on again).
- Bit1 1: Z pulse outputs according to the two-phase quadrature (need to power-on again);  
0: Z pulse outputs according to (pulse + direction) (need to power-on again).
- Bit0 1: X pulse outputs according to the two-phase quadrature (need to power-on again);  
0: X pulse outputs according to (pulse + direction) (need to power-on again).

### 3.2.2 Acceleration & deceleration control

**0 2 2** **RPDFn**

[Data type] Word axis

[Data meaning] max. speed of X rapid traverse (radius value)

[Data unit]

Setting unit	Data unit
Metric machine	mm/min
Inch machine	0.1inch/min

[Data range] 10~99999999

**0 2 3** **LINTn**

[Data type] Word axis

[Data meaning] Acceleration/deceleration time constant value

[Data unit] ms

[Data range] 10~4000

**0 2 7** **FEDM**

[Data meaning] Upper limit of cutting feedrate

[Data unit]

Setting unit	Data unit
Metric machine	mm/min
Inch machine	0.1inch/min

[Data range]

	IS-B	IS-C
Metric machine	10~15000	10~15000
Inch machine	5~5800	10~5800

**0 2 9** **FEEDT**

[Data meaning] Acceleration/deceleration time constant during cutting feed and manual feed

[Data unit] ms

[Data range] 0~4000

**0 3 0** **FEDFL**

[Data meaning] The starting speed of cutting feed

[Data unit]

Setting unit	Data unit
Metric machine	mm/min
Inch machine	0.1inch/min

[Data range]

	IS-B	IS-C

Metric machine	0~8000	0~8000
Inch machine	0~3000	0~3000

**0 3 1**

**JOGSPEED**

[Data meaning] Set speed when manual feedrate override is 100%

[Data unit]

Setting unit	Data unit
Metric machine	mm/min
Inch machine	0.1inch/min

[Data range] 10~30000

**0 3 2**

**RPDFLn**

[Data type] Word axis

[Data meaning] The rapid traverse rate when the override is F0

[Data unit]

Setting unit	Data unit
Metric machine	mm/min
Inch machine	0.1inch/min

[Data range]

	IS-B	IS-C
Metric machine	0~4000	0~4000
Inch machine	0~1500	0~1500

### 3.2.3 Precision compensation

**0 0 3**

**PEC**

Bit5 1: Pitch error offset active

0: Pitch error offset inactive

**0 1 0**

**CPF5 CPF4 CPF3 CPF2 CPF1**

CPF4~CPF1: Setting values of backlash offset pulse frequency (by BCD code)

The set frequency =(setting value+1) Kpps

CPF5	CPF4	CPF3	CPF2	CPF1	Set frequency(Kpps)
0	0	0	0	0	1
0	0	0	0	1	2
0	0	0	1	0	3
0	0	0	1	1	4
0	0	1	0	0	5
0	0	1	0	1	6
0	0	1	1	0	7
0	0	1	1	1	8
0	1	0	0	0	9

0	1	0	0	1	10
0	1	0	1	0	11
0	1	0	1	1	12
0	1	1	0	0	13
0	1	1	0	1	14
0	1	1	1	0	15
0	1	1	1	1	16
1	0	0	0	0	17
1	0	0	0	1	18
1	0	0	1	0	19
1	0	0	1	1	20
1	0	1	0	0	21
1	0	1	0	1	22
1	0	1	1	0	23
1	0	1	1	1	24
1	1	0	0	0	25
1	1	0	0	1	26
1	1	0	1	0	27
1	1	0	1	1	28
1	1	1	0	0	29
1	1	1	0	1	30
1	1	1	1	0	31
1	1	1	1	1	32

0	1	1	<b>BDEC</b>	<b>BD8</b>					
---	---	---	-------------	------------	--	--	--	--	--

- BDEC** 1: Backlash offset type B, the offset data are output by ascending or descending type and the set frequency is inactive;  
 0: Backlash offset type A, the offset data are output by the set frequency (by bit parameter No.010) or 1/8 of it;
- BD8** 1: Backlash offset is done by the 1/8 of the set frequency;  
 0: Backlash offset is done by the set frequency;

0	3	4	<b>BKLn</b>
---	---	---	-------------

[Data type] Word axis  
 [Data meaning] BKLX (X axis) ,BKLZ (Z axis) backlash compensation.  
 [Data unit]

Set unit	IS-B	IS-C
Metric machine	0.001 mm	0.0001 mm
Inch machine	0.0001 inch	0.00001 inch
Data range	2000	20000

[Data range] 0~2000

Note: X is diameter value.

0 9 6	<b>PECMINn</b>
-------	----------------

[Data type] Word axis

[Data meaning] Minimum pitch error compensation number

[Data range] 0~1023

0 9 7	<b>PECMAXn</b>
-------	----------------

[Data type] Word axis

[Data meaning] Maximum pitch error compensation number

[Data range] 0~1023

0 9 8	<b>PECORGn</b>
-------	----------------

[Data type] Word axis

[Data meaning] Pitch error compensation number corresponding to machine zero

[Data range] 0~1023

0 9 9	<b>PECINTn</b>
-------	----------------

[Data type] Word axis

[Data meaning] Pitch error compensation intervals

[Data unit]

Setting unit	IS-B	IS-C
Metric machine	0.001 mm	0.0001 mm
Inch machine	0.0001 inch	0.00001 inch

[Data range]

	IS-B	IS-C
Metric machine	1000~999999	10000~9999999
Inch machine	400~999999	4000~9999999

### 3.2.4 Machine protection

1 7 2	***	MST	MSP	MOT	ESP	***	LZR	***
-------	-----	-----	-----	-----	-----	-----	-----	-----

Bit6 1: External cycle start signal (ST) inactive, it is not the cycle start switch and can be defined by macro code (#1014);

0: External cycle start signal (ST) active.

Bit5 1: External SP signal inactive, and it is not the dwell switch and can be defined by macro code. (#1015);

0: External SP signal active with external dwell switch connected, otherwise CNC shows "stop". <mailto:M@SP=1>

Bit4 1: Do not detect software stroke limit;

0: Detect software stroke limit.

Bit3 1: Emergency stop inactive;

0: Emergency stop active;

Bit1 1: The software limit is valid after system is energized and before machine zero return is performed;

0: The software limit is invalid after system is energized and before machine zero return is performed;

0	4	5
0	4	6

LT1n1
LT1n2

[Data type] Word axis

[Data meaning] LT1n1: Maximum stroke on positive direction; LT1n2: Maximum stroke on negative direction

[Data Unit]

Setting unit	IS-B	IS-C
Metric machine	0.001 mm	0.0001 mm
Inch	0.0001 inch	0.00001 inch

[Data range] -99999999~99999999

**Note:** When bit 2 of parameter No. 001 set diameter programming, X axis is set by diameter system; when bit 2 set radius programming, X axis is set by radius system.

PLC parameter

D	T	0	2
---	---	---	---

PEALMTIM
----------

[Data meaning] Under-pressure alarm detection time

[Data unit] ms

[Data range] 0~2147483647

D	T	2	1
---	---	---	---

PSANGNT
---------

[Data meaning] Chuck operation delay time after spindle stop;

[Data unit] ms

[Data range] 0~2147483647

Volume III Connection

### 3.2.5 Machine zero return

0	0	4
---	---	---

***	DECI	***				
-----	------	-----	--	--	--	--

Bit5 1: Deceleration begins as DEC signal is connected to +24V in machine zero return  
0: Deceleration begins as DEC signal is disconnected to +24V in machine zero return

0	0	5
---	---	---

						PPD	
--	--	--	--	--	--	-----	--

Bit1 1: Relative and absolute coordinate set together for absolute setting and reference return by G50  
0: Only absolute coordinate set for absolute setting and reference point by G50

0	0	6
---	---	---

		ZM5	ZM4	ZMY	ZMZ	ZMX
--	--	-----	-----	-----	-----	-----

ZMX, ZMZ, ZMY, ZM4, ZM5: Return and initial backlash direction of X, Y, Z axes machine zeroes at power on  
0: Zero return type C, machine zero return and backlash direction is positive;  
1: Zero return type B, machine zero return and backlash direction is negative.

0	0	7				ZC5	ZC4	ZCY	ZCZ	ZCX
---	---	---	--	--	--	-----	-----	-----	-----	-----

ZCX, ZCZ, ZCY, ZC4, ZC5 =0: Separate DEC and zero signals needed during machine zero return

=1: DEC and zero signals together by a proximity switch during machine zero return

**Note:** This parameter should be set to 1 if a proximity switch is taken as both deceleration and zero signal.

0	1	1			***	***	NORF	ZNIK	***	***
---	---	---	--	--	-----	-----	------	------	-----	-----

Bit3 1: Manual machine zero return inactivity

0: Manual machine zero return active

Bit2 1: Stop at zero by pressing direction key once in zero return with direction key locked;

0: Direction key should be held on in zero return with direction key unlocked.

0	1	2	APRS			***		***		ISOT
---	---	---	------	--	--	-----	--	-----	--	------

Bit7 1: ABSOLUTE automatically set after reference return, the coordinate set by parameter No.049 and No.050;

0: ABSOLUTE not automatically set after reference return

Bit 6 1: Prior to machine zero return after power-on or E-stop, manual rapid traverse active

0: Prior to machine zero return after power-on or E-stop, manual rapid traverse inactive

0	1	4				ZRS5	ZRS4	ZRSY	ZRSZ	ZRSX
---	---	---	--	--	--	------	------	------	------	------

Bit4, Bit3, Bit2, Bit1, Bit0 1: 5<sup>th</sup>, 4<sup>th</sup>, Y, Z, X has machine zero, the system detects DEC signal and zero signal in executing machine zero return.

0: 5<sup>th</sup>, 4<sup>th</sup>, Y, Z, X has machine zero, the system does not detect DEC signal and zero signal in executing machine zero return

1	8	3	***	***	***	MZRY	MZRY	MZRY	MZRZ	MARX
---	---	---	-----	-----	-----	------	------	------	------	------

Bit4 1: 5<sup>th</sup> press key\_ to execute machine zero return;

0: 5<sup>th</sup> press key\_ to execute machine zero return (has not defined the press key in the standard PLC)

Bit3 1: 4<sup>th</sup>  to execute the machine zero return;

0: 4<sup>th</sup>  to execute the machine zero return.

Bit2 1: Y  to execute the machine zero return;

0: Y  to execute the machine zero return.

Bit1 1: Z  to execute the machine zero return;

0: Z  to execute the machine zero return.

Bit0 1: X  to execute the machine zero return;

0: X  to execute the machine zero return.

1	8	8	***	RRTn	***	***	***			
---	---	---	-----	------	-----	-----	-----	--	--	--

[Data type] Bit axis

RRTn 1: when Y,4<sup>th</sup>, 5<sup>th</sup> are rotary axis, the zero return use D mode;

0: when Y,4<sup>th</sup>,5<sup>th</sup> are rotary axis, the zero return use A, B,C mode( need to power-on again).

0 3 3

ZRNFL

[Data type]  
[Data meaning]  
[Data unit]

Word axis  
Lowest speed rate of X,Z machine zero return.

Set unit	Data unit
Metric machine	mm/min
Inch machine	0.1inch/min

[Data range] 6~4000

0 4 7

PRSn

[Data type]  
[Data meaning]  
[Data unit]

Word axis  
Setting value of absolute coordinate after machine zero return is performed

Setting unit	IS-B	IS-C
Metric input	0.001 mm	0.0001 mm
Inch input	0.0001 inch	0.00001 inch

[Data range] -99999999~99999999

1 1 3

REF\_SPD

[Data meaning]  
[Data unit]

high-speed of X,Z machine zero return.

Set unit	Data unit
Metric machine	mm/min
Inch machine	0.1inch/min

[Data range] 10~921571875

1 1 4

REF\_OFFSETX

[Data type]  
[Data meaning]  
[Data unit]

Word axis  
Offset value of machine zero point

Set unit	IS-B	IS-C
Metric input	0.001 mm	0.0001 mm
Inch input	0.0001 inch	0.00001 inch

[Data range] -99999~99999

1 2 0  
1 2 1  
1 2 2  
1 2 3

REF1\_COORDn  
REF2\_COORDn  
REF3\_COORDn  
REF4\_COORDn



### 3.2.6 Threading function

1	7	5				THDA				
---	---	---	--	--	--	------	--	--	--	--

THDA 1: Exponential ACC&DEC for threading

0: Linear ACC&DEC for threading

0	1	9	THDCH							
---	---	---	-------	--	--	--	--	--	--	--

[Data meaning]

thread run-out length in thread cutting.

[Data range]

0~225

Thread run-out width=THDCH×0.1×thread lead

0	2	6	THRDT							
---	---	---	-------	--	--	--	--	--	--	--

[Data meaning]

short acceleration/deceleration time constant in thread run-out.

[Data unit]

ms

[Data range]

0~4000

0	2	8	THDFL							
---	---	---	-------	--	--	--	--	--	--	--

[Data meaning]

X, Z initial speed in thread cutting.

[Data unit]

Set unit	Data unit
Metric machine	mm/min
Inch machine	0.1inch/min

[Data range]

6~8000

0	7	0	ENCODER_CNT							
---	---	---	-------------	--	--	--	--	--	--	--

[Data meaning]

spindle encoder lines.

[Data unit]

Line/r

[Data range]

100~5000

1	1	0	MGR							
---	---	---	-----	--	--	--	--	--	--	--

[Data meaning]

ratio parameter between encoder and spindle gear: spindle gear quantity.

[Data range]

1~255

1	1	1	SGR							
---	---	---	-----	--	--	--	--	--	--	--

[Data meaning]

ratio parameter between encoder and spindle gear: spindle gear quantity.

[Data range]

1~255

### 3.2.7 Spindle control

0	0	1				SPIN				
---	---	---	--	--	--	------	--	--	--	--

Bit4 1: Analog voltage control of spindle speed

0: Switching volume control of spindle speed

K	1	0						RSJG		
---	---	---	--	--	--	--	--	------	--	--

RSJG 1: when the reset is pressed, CNC does not close M03,M04,M08,M32 output signal;  
 0: when the reset is pressed, CNC closes M03, M04, M08, M32 output signal

0	2	1
---	---	---

[Data meaning]

[Data unit]

[Data range]

<b>PSANGNT</b>
----------------

voltage offset compensation value when the analog voltage outputs 10V.

mV

-2000~2000

0	3	6
---	---	---

[Data meaning]

[Data unit]

[Data range]

<b>SPDLC</b>
--------------

voltage offset compensation value when the analog voltage outputs 10V.

mV

-1000~1000

0	3	7
0	3	8
0	3	9
0	4	0

[Data meaning]

<b>GRMAX1</b>
<b>GRMAX2</b>
<b>GRMAX3</b>
<b>GRMAX4</b>

GRMAX1, GRMAX2, GRMAX3, GRMAX4: Max. speeds of spindle gear 1, 2, 3, 4 respectively when analog voltage output is 10V (function defined by GSK980TDc PLC: if the spindle automatic gearing is active, they are the speeds of M41, M42, M43, M44; if the automatic gearing is inactive or CNC is powered on, the gears are memorized by parameter setting or the gear 1 is defaulted.)

[Data unit]

r/min

[Data range]

10~9999

0	6	7
---	---	---

[Data meaning]

[Data unit]

[Data range]

<b>SFTREV</b>
---------------

output voltage in spindle gear shifting.

mV

0~10000

0	6	8
---	---	---

[Data meaning]

[Data unit]

[Data range]

<b>SJOGREV</b>
----------------

spindle rotary axis speed in Manual (MPG) mode.

r/min

0~3000

0	6	9
---	---	---

[Data meaning]

[Data unit]

[Data range]

<b>PEALMTIM</b>
-----------------

pressure low alarm time width.

ms

0~60000

0	7	0
---	---	---

[Data meaning]

[Data unit]

<b>ENCODER_CNT</b>
--------------------

spindle encoder lines.

line/r

[Data range] 100~5000

**0 7 1**

**RESET\_TIME**

[Data meaning] reset signal output time.

[Data unit] ms

[Data range] 16~4080

**0 7 2**

**SAR\_DELEY**

[Data meaning] spindle speed arrival signal delay check time.

[Data unit] ms

[Data range] 0~4080

**0 7 3**

**SPMOTORMAX**

[Data meaning] max. clamp speed of spindle motor speed.

[Data unit] r/min

[Data range] 0~4095

Setting value= (max. clamp speed of spindle motor/its max. speed) ×4095.

**0 7 4**

**SPMOTORMIN**

[Data meaning] min. clamp speed of spindle motor speed.

[Data unit] r/min

[Data range] 0~4095

Setting value= (min. clamp speed of spindle motor/its min. speed) ×4095.

**0 7 5**

**SPSPEEDLIMIT**

[Data meaning] max. spindle speed [0: not limit speed] .

[Data unit] r/min

[Data range] 0~6000

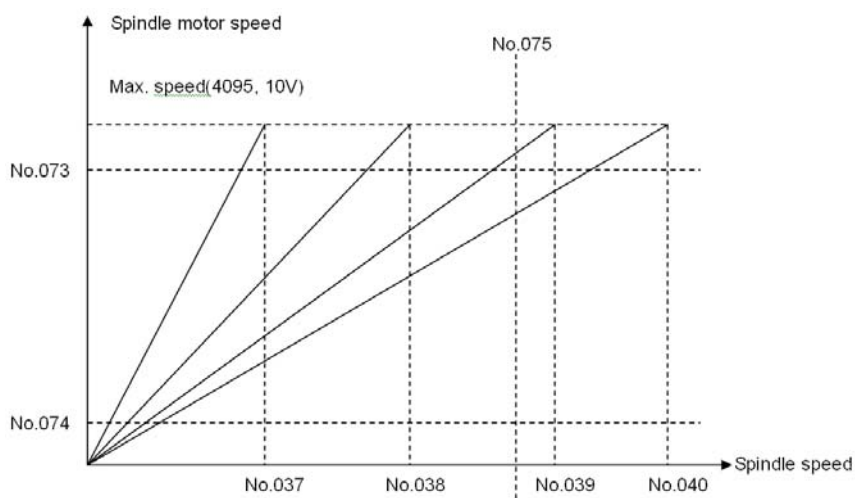

**1 0 9**

**SPL\_REV\_SPD**

[Data meaning] rotary speed in spindle jog.



Inch input	1~99999	1~999999
------------	---------	----------

### 3.2.11 Edit and display

0	0	5					<b>M30</b>			
---	---	---	--	--	--	--	------------	--	--	--

M30 1: Cursor to beginning after M30

0: Cursor to beginning by pressing CYCLE START key after M30

0	1	2					<b>EAL</b>		<b>EBCL</b>	
---	---	---	--	--	--	--	------------	--	-------------	--

EAL 1: Program editing allowed during CNC alarming

0: Program editing unallowed during CNC alarming

EBCL 1: Program end sign EOB displayed for “;”

0: Program end sign EOB displayed for “\*”

1	8	0								<b>SPOS</b>
---	---	---	--	--	--	--	--	--	--	-------------

Bit0 =1: DIS TO GO displayed in POS&PRG page

=0: RELATIVE POS displayed in POS&PRG page

1	8	4	***	<b>PTEST</b>	***	***	***	<b>L2</b>	<b>L1</b>	<b>L0</b>
---	---	---	-----	--------------	-----	-----	-----	-----------	-----------	-----------

Bit0, Bit1, Bit2: Interface language selection

Language	Bit2	Bit1	Bit0
Chinese	0	0	0
English	0	0	1
Portugal	0	1	0
Spanish	0	1	1
Russian	1	1	0

### 3.2.12 Communication setting

0	4	4	<b>BRATE0</b>							
---	---	---	---------------	--	--	--	--	--	--	--

[Data meaning]

baud rate of serial communication.

[Data unit]

bit/s

[Data range]

1200,2400,4800,9600,19200,38400,57600 ,115200

### 3.2.13 MPG Parameters

0	0	1		***	***		<b>MPG</b>			
---	---	---	--	-----	-----	--	------------	--	--	--

Bit3 1: MPG mode

0: Step mode

0	1	3	***	***	***	<b>HW5</b>	<b>HW4</b>	<b>HWY</b>	<b>HWZ</b>	<b>HWX</b>
---	---	---	-----	-----	-----	------------	------------	------------	------------	------------

Bit4 1: coordinates increase when 5<sup>th</sup> MPG rotates CCW;

0: coordinates increase when 5<sup>th</sup> MPG rotates CW.

Bit3 1: coordinates increase when 4<sup>th</sup> MPG rotates CCW;

0: coordinates increase when 4<sup>th</sup> MPG rotates CW.

- Bit2 1: coordinates increase when Y MPG rotates CCW;  
0: coordinates increase when Y MPG rotates CW.
- Bit1 1: coordinates increase when Z MPG rotates CCW;  
0: coordinates increase when Z MPG rotates CW.
- Bit0 1: coordinates increase when X MPG rotates CCW;  
0: coordinates increase when X MPG rotates CW.

K	1	6	SINC	SINC2	***	***	***	***	***	***
---	---	---	------	-------	-----	-----	-----	-----	-----	-----

- Bit7 1: In STEP(MPG) mode and when the system increment is 0.1u, ×1000 gear is invalid,  
0: In STEP(MPG) mode and when the system increment is 0.1u, ×1000 gear is valid,
- Bit6 1: In STEP(MPG) mode and when the system increment is 1u, ×1000 gear is invalid,  
0: In STEP(MPG) mode and when the system increment is 1u, ×1000 gear is valid,

**Note:** to avoid the step-out, the parameter should be set to 1 when the system is matched with the stepper drive unit.

### 3.2.14 PLC axis control function

1	8	5				***	***	***	PRPD	PLA
---	---	---	--	--	--	-----	-----	-----	------	-----

- PRPD 1: Rapid traverse rate of PLC axis by input value  
0: Rapid traverse rate of PLC axis by parameter value (X axis: No.022; Z axis:No.023; Y axis:No.155;)
- PLA 1: PLC axis control active, and active after repowering  
0: PLC axis control inactive, and active after repowering

**Note:** The PLC axis control function is only provided by machine builder.

2	1	9	PLCDIDOn							
---	---	---	----------	--	--	--	--	--	--	--

- [Data type] Word axis
- [Data meaning] Select DI/DO in PLC axis control PLC
- [Data unit]
- [Data range] 0~4

### 3.2.15 Skip function

1	8	5	SK0	SKF		***	***	***		
---	---	---	-----	-----	--	-----	-----	-----	--	--

- SK0 1: Skip input active as G31 signal is 0  
0: Skip input active as G31 signal is 1
- SKF 1: Feedrate override per minute or dry run active for G31  
0: Feedrate override per minute or dry run inactive for G31

**Note:** The skip function is only provided by machine builder.

### 3.2.16 Automatic tool setting function

1	8	5		AEO	***	***	***			
---	---	---	--	-----	-----	-----	-----	--	--	--

- AWO 1: when G36, G37 signal (XAE, ZAE) is 0, the input is valid;  
0: G36, G37 signal (XAE, ZAE) is 1, the input is valid.

1	4	1
---	---	---

[Data meaning]

[Data unit]

<b>AUTO_OFFSET_FEED</b>
-------------------------

feedrate in automatic tool compensation measure.

Set unit	Data unit
Metric machine	mm/min
Inch machine	0.1inch/min

[Data range]

	IS-B	IS-C
Metric machine	15~1000	15~1000
Inch machine	7~375	7~375

1	4	2
1	4	3

[Data meaning]

[Data unit]

<b>AUTO_OFFSET_Y_X</b>
------------------------

<b>AUTO_OFFSET_Y_Z</b>
------------------------

X (AUTO\_OFFSET\_Y\_X), Z (AUTO\_OFFSET\_Y\_Z) γ value in automatic tool offset.

Set unit	IS-B	IS-C
Metric machine	0.001 mm	0.0001 mm
Inch machine	0.0001 inch	0.00001 inch

[Data range]

1~9999999

**Note: X setting value is the radius in diameter programming and radius programming.**

1	4	4
1	4	5

[Data meaning]

**Note: The function needs the automatic tool setting device.**

<b>AUTO_OFFSET_E_X</b>
------------------------

<b>AUTO_OFFSET_E_Z</b>
------------------------

AUTO\_OFFSET\_E\_X (X), AUTO\_OFFSET\_E\_Z (Z) ε value in automatic tool offset.

### 3.2.17 Input and output function in metric and inch system

0	0	1
---	---	---

INI 1: Inch input

0: Metric input

	***	***						INI
--	-----	-----	--	--	--	--	--	-----

0	0	3
---	---	---

OIM 1: Offset automatically change in metric and inch conversion

0: Offset not change in metric and inch conversion

***	***			***	***	***	OIM
-----	-----	--	--	-----	-----	-----	-----

0	0	4
---	---	---

SCW 1: Inch system for min. code unit, active after repowering

0: Metric system for min. code unit, active after repowering

***							SCW
-----	--	--	--	--	--	--	-----

### 3.2.18 Parameters related to arc turning

1 5 4

RADIUS\_ERR\_RANGE

[Data meaning]

max. value of arc radius error.

[Data unit]

Setting unit	IS-B	IS-C
Metric machine	0.001 mm	0.0001 mm
Inch machine	0.0001 inch	0.00001 inch

[Data range]

	IS-B	IS-C
Metric machine	0~1000	0~10000
Inch machine	0~50	0~500

### 3.2.19 Parameters related to the additional

1 8 7

YIS1Y Y ISO RCSY \*\*\* \*\*\* \*\*\* ROSY ROTY

[Data type]: Bit axis

BIT7,BIT6: set Y incremental system, 00: consistent with the incremental system of the system, 01: IS-A, 10: IS-B; 11: IS-C.

Bit5 1: Y Cs function is valid/invalid;  
0: Y Cs function is valid/invalid.

Bit1,Bit0: 00 sets Y to be the linear, 01 sets Y to be the rotary(A type), 11 sets Y to be the rotary (B type), 10 sets Y to be invalid.

**Note: This parameter is invalid to axes X and Y.**

1 8 8

\*\*\* RRTY \*\*\* \*\*\* \*\*\* RRLY RABY ROAY

[Data type]: Bit axis

Bit6 1: When Y is a rotary axis, the zero return uses D mode;  
0: When Y is a rotary axis, the zero return uses A, B, C.

Bit2 1: When Y is a rotary axis, the relative coordinate cycle function is valid;  
0: When Y is a rotary axis, the relative coordinate cycle function is invalid

Bit1 1: When Y is a rotary axis, its rotation direction is based on the symbol direction;  
0: When Y is a rotary axis, its rotation direction is contiguous.

Bit0 1: When Y is a rotary axis, the absolute coordinate cycle function is valid;  
0: When Y is a rotary axis, the absolute coordinate cycle function is invalid

**Note: This parameter is invalid to axes X and Y.**

2 1 6

ROT\_REVn

[Data type] Word axis

[Data meaning] Axis movement per rotation (when the auxiliary axes are rotary axes)

[Data unit]

Setting Unit	IS-B	IS-C
Rotary axis	0.001 deg	0.0001 deg



[Data range] 1000~99999999

**2 2 4**

**AXISNUM**

[Data meaning] The displayed axis number

[Data range] 2~5

**2 2 5**

**NAME\_n**

[Data type] Word axis

[Data meaning] axis name definitions

[Data range] 65, 66, 67, 88, 89, 90

Axis name	Setting value	Axis name	Setting value	Axis name	Setting value
X	88	A	65	C	67
Z	90	B	66	Y	89

**2 3 0**

**ATTRIB\_n**

[Data type] Word axis

[Data meaning] The properties of each axis in coordinate system

[Data range] 0~7

Setting value	Meaning
0	Neither the basic three axes nor the parallel axis
1	X axis of the basic three axes
2	Y axis of the basic three axes
3	Z axis of the basic three axes
5	Parallel axis of X axis
6	Parallel axis of Y axis
7	Parallel axis of Z axis

## CHAPTER 4 MACHINE DEBUGGING METHODS AND MODES

The trial run methods and steps at initial power on for this GSK980Tdc/GSK980Tdc-V are described in this chapter. The corresponding operation can be performed after the debugging by the following steps.

### 4.1 Emergency Stop and Limit

This GSK980Tdc/GSK980Tdc-V system has software limit function, it is suggested that hardware limit is employed by fixing the stroke limit switches in the positive or negative axes. The connection is as follows (2 axes):

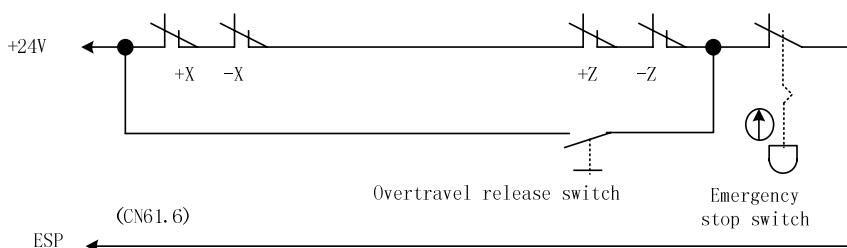

Fig. 4-1

So the BIT3 (ESP) of bit parameter No.172 should be set to 0.

The diagnostic message DGN000.7 monitors the emergency stop input signal.

In Manual or MPG mode, slowly move the axes to testify the validity of stroke limit switch, correctness of alarm display, validity of overtravel release button. When the overtravel occurs or Emergency Stop button is pressed, "emergency stop" alarm will be issued by CNC system. The alarm can be cancelled by pressing down the OVERTRAVEL key for reverse moving.

### 4.2 Drive Unit Configuration

BIT4, BIT3, BIT2, BIT1, BIT0 (5ALM, 4ALM, YALM, ZALM, XALM separately corresponds to 5th, 4th, Y, Z, X) of bit parameter No.009 for GSK drive unit are all set to 1 according to the alarm logic level of the drive unit.

If the machine moving direction is not consistent with the move code, modify BIT4, BIT3, BIT2, BIT1 and BIT0 (DIR5, DIR4, DIRY, DIRZ, DIRX separately corresponds to 5th, 4th, Y, Z, X) of bit parameter No.008.

The manual move direction can be set by BIT4, BIT3, BIT2, BIT1, BIT0 (5VAL, 4VAL, YVAL, ZVAL, XVAL separately corresponds to 5th, 4th, Y, Z, X movement key) of bit parameter No.175.

### 4.3 Gear Ratio Adjustment

The data parameter No.015~No.018 can be modified for electronic gear ratio adjustment to meet the various mechanical transmission ratios if the machine travel distance is not consistent with the displacement distance displayed by the CNC.

Formula:

$$\frac{CMR}{CMD} = \frac{\delta \times 360}{\alpha \times L} \times \frac{Z_M}{Z_D}$$

CMR: Code multiplier coefficient (data parameter No.015, No.016, No.146, No.147, No.148)

CMD: Code frequency division coefficient (data parameter No.017, No.018, No.149, No.150, No.151)

$\alpha$  : Pulse volume, motor rotation angle for a pulse

L: Screw lead

$\delta$ : Min. input code unit of CNC(0.001mm for GSK980TDc Z axis, 0.0005mm for X axis of GSK980TDc)

$Z_M$  : gear teeth number of lead screw

$Z_D$ : gear teeth number of motor

Example: if gear teeth number of lead is 50, gear teeth number of motor is 30, pulse volume  $\alpha = 0.075^\circ$ , screw lead is 4mm,

The electronic gear ratio of X axis is: 
$$\frac{CMR}{CMD} = \frac{\delta \times 360}{\alpha \times L} \times \frac{Z_M}{Z_D} = \frac{0.0005 \times 360}{0.075 \times 4} \times \frac{50}{30} = \frac{1}{1}$$

The electronic gear ratio of Z axis is: 
$$\frac{CMR}{CMD} = \frac{\delta \times 360}{\alpha \times L} \times \frac{Z_M}{Z_D} = \frac{0.001 \times 360}{0.075 \times 4} \times \frac{50}{30} = \frac{2}{1}$$

Then data parameter No.015(CMRX) =1, No.017(CMDX) =1; No.016(CMRZ) =2, No.018(CMDZ) =1.

If the electronic gear ratio numerator is more than the denominator, the allowed CNC max. speed will decrease. For example: the data parameter No.016(CMRZ) =2, No.018(CMDZ) =1, so the allowed Z axis max. speed is 8000mm/min.

If the electronic gear ratio numerator is not equal to the denominator, the allowed CNC positioning precision may decrease. For example: the data parameter No.016(CMRZ) =1, No.018(CMDZ) =5, so the pulse is not output as the input increment is 0.004, but a pulse is output if the input increment is 0.005.

In order to ensure the CNC positioning precision and speed index, it is suggested that the CNC electronic gear ratio is set to 1:1 and the electronic gear ratio calculated is set to the digital servo when matching with digital servo.

When matching with the step drive, choose the drive unit with step division function as possible as it can, and properly select mechanical transmission ratio. The 1:1 electronic gear ratio should be ensured to avoid the excessive difference between the numerator and the denominator of this CNC electronic gear ratio.

#### 4.4 ACC&DEC Characteristic Adjustment

Adjust the relative CNC parameters according to the factors such as the drive unit, motor characteristics and machine load:

Data parameter No.022, No.023, №155, №156, №157: X, Z, Y, 4<sup>th</sup>, 5<sup>th</sup> axis rapid traverse rate;

Data parameter No.024, No.025, №158, №159, №160: linear ACC&DEC time constant of X, Z, Y, 4<sup>th</sup>, 5<sup>th</sup> axis rapid traverse rate;

Data parameter No.026: X axis exponential ACC&DEC time constant in threading;

Data parameter No.028: Exponential ACC&DEC start/end speed in threading;

Data parameter No.029: Exponential ACC&DEC time constant of cutting and manual feeding;

Data parameter No.030: Exponential ACC&DEC start/end speed in cutting feeding;

BIT5 (SMZ) of bit parameter No.007: for smooth transition between cutting feedrates of adjacent

blocks

The larger the ACC&DEC time constant is, the slower the ACC&DEC is, the smaller the machine movement impact and the lower the machining efficiency is, and vice versa.

If ACC&DEC time constants are equal, the higher the ACC&DEC start/end speed is, the faster the ACC&DEC is, the bigger the machine movement impact and the higher the machining efficiency is, and vice versa.

The principle for ACC&DEC characteristic adjustment is to properly reduce the ACC&DEC time constant and increase the ACC&DEC start/end speed to improve the machining efficiency on the condition that there is no alarm, motor out-of-step and obvious machine impact. If the ACC&DEC time constant is set too small, and the start/end speed is set too large, it is easily to cause faults such as drive unit alarm, motor out-of-step or machine vibration.

When the bit parameter No.007 BIT5(SMZ) =1, the feedrate drops to the start speed of the ACC&DEC at the cutting path intersection, then it accelerates to the specified speed of the next block to obtain an accurate positioning at the path intersection, but this will reduce the machining efficiency. When BIT5=0, the adjacent cutting path transits smoothly by the ACC&DEC. The feedrate does not always drop to the start speed when the previous path is finished and a circular transition (non-accurate positioning) will be formed at the path intersection. The machining surface by this path transition has a good finish and a higher machining efficiency. When the stepper motor drive unit is applied, the BIT5 of the bit parameter No.007 should be set to 1 to avoid the out-of-step.

When the stepper motor drive unit is applied, the out-of-step may occur on the condition that rapid traverse speed is too large, ACC&DEC time constant is too small, ACC&DEC start/end speed is too large. The suggested parameter setting is as follows (the electronic gear ratio 1:1):

Data parameter No.022≤2500	Data parameter No.023≤5000
Data parameter No.155≤5000	Data parameter No.158≥350
Data parameter No.024≥350	Data parameter No.025≥350
Data parameter No.029≥150	Data parameter No.028≤100
Data parameter No.026≥200	Data parameter No.030≤50

If AC servo drive unit is applied to this system, the machining efficiency can be improved by a larger start speed and a smaller ACC&DEC time constant setting. If optimum acc/dec characteristics are required, the ACC&DEC time constant may be set to 0 which can be gotten by adjusting the AC servo acc/dec parameters. The suggested settings for these parameters are as follows(electronic gear ratio is 1:1):

Data parameter No.022=5000	Data parameter No.023=10000
Data parameter No.155=10000	Data parameter No.158≤60
Data parameter No.024≤60	Data parameter No.025≤60
Data parameter No.029≤50	Data parameter No.028≤500
Data parameter No.026≤50	Data parameter No.030≤400

The parameter settings above are recommended for use, please refer to the actual conditions of the drive unit, motor characteristic and motor load for their proper setting.

### 4.5 Mechanical (Machine) Zero Adjustment

Adjust the relevant parameters based on the active level of the connection signal, zero return type and direction applied:

BIT5 (DECI) of the bit parameter No.004: active level of deceleration signal in machine zero return.

BIT0, BIT1, BIT2, BIT3, BIT4 (ZMX, ZMZ, ZMY, ZM4, ZM5) of the bit parameter No.006: X, Z,

Y, 4<sup>th</sup>, 5<sup>th</sup> axis machine zero return mode B or C selection.

BIT0, BIT1, BIT2, BIT3, BIT4 (ZCX, ZCZ, ZCY, ZC4, ZC5) of the bit parameter No.007: whether a proximity switch is taken as both deceleration and zero signals.

BIT2(ZNLK) of the bit parameter No.011: whether the direction key in zero return is self-locked.

BIT0, BIT1, BIT2, BIT3, BIT4(ZRSCX, ZRSCZ, ZRSCY, ZRSC4, ZRSC5) of the bit parameter No.014: have/not the machine zero(zero turn mode BC/A)setting bit.

Data parameter No.033: low deceleration speeds of each axis in machine zero return.

Data parameter No.113: high speed of each axis in machine zero return.

BIT0, BIT1, BIT2, BIT3, BIT4(MZRX, MZRZ, MZRY, MZR4, MZR5) of the bit parameter No.183: each axis zero return direction: negative or positive.

Only the stroke limit switch validity is confirmed, can the machine zero return be performed.

The machine zero is usually fixed at the max. travel point, and the effective stroke of the zero return touch block should be more than 25mm to ensure a sufficient deceleration distance for accurate zero return. The more rapid the machine zero return is, the longer the zero return touch block should be. Or the moving carriage will rush over the block and it may affect the zero return precision because of the insufficient deceleration distance.

Usually there are 2 types of machine zero return connection:

① The connection to AC servo motor: using a travel switch and servo motor one-turn signal separately

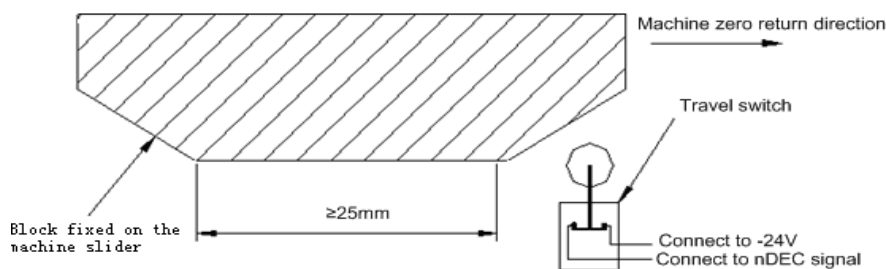

Fig. 4-2

By this connection, when the deceleration switch is released in machine zero return, the one-turn signal of encoder should be avoided to be at a critical point after the travel switch is released. In order to improve the zero return precision, and it should ensure the motor reaches the one-turn signal of encoder after it rotates half circle.

The parameter setting is as follows:

Bit parameter No.004 BIT5(DEC1) =0

Bit parameter No.006 BIT0(ZMX) , BIT1(ZMZ) , BIT2(ZMY) , BIT3(ZM4) , BIT4(ZM5) =0

Bit parameter No.007 BIT0(ZCX) , BIT1(ZCZ) , BIT2(ZCY) , BIT3(ZC4) , BIT4(ZC5)=0

Bit parameter No.011 BIT2(ZNLK) =1

Bit parameter No.014 BIT0(ZRSCX) , BIT1(ZRSCZ) , BIT2(ZRSCY) , BIT3(ZRSC4) , BIT4(ZRSC5) =1

Data parameter No.033=200

Data parameter No.183 BIT0(MZRX) , BIT1(MZRZ) , BIT2(MZRY) , BIT3(MZR4) , BIT4(MZR5) =0

② The connection to stepper motor: schematic diagram of using a proximity switch taken as both deceleration signal and zero signal

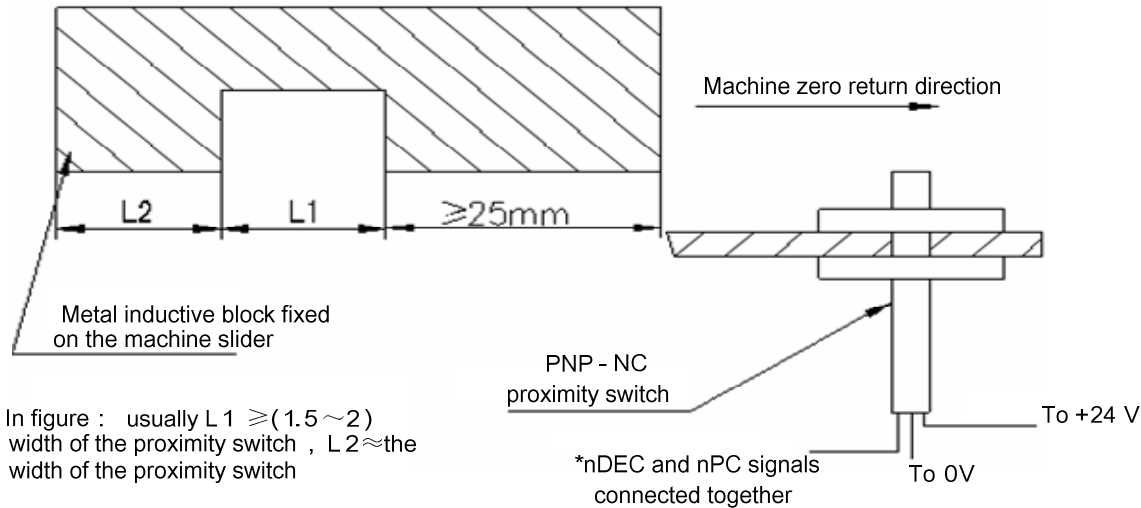

Fig. 4-3

When matching the stepper motor, it is better to adjust the rapid override to 50% to avoid the out-of-step during rapid traversing of zero return, so the parameter settings are as follows:

Bit parameter No.004 BIT5(DECL) =0

Bit parameter No.006 BIT0(ZMX) , BIT1(ZMZ) , BIT2(ZMY) , BIT3(ZM4) , BIT4(ZM5) =0

Bit parameter No.007 BIT0(ZCX) , BIT1(ZCZ) , BIT2(ZCY) , BIT3(ZC4) , BIT4(ZC5) =1

Bit parameter No.011 BIT2(ZNLK) =0

Bit parameter No.014 BIT0(ZRSCX) , BIT1(ZRSCZ) , BIT2(ZRSCY) , BIT3(ZRSC4) , BIT4(ZRSC5)

=1

Data parameter No.033=200

Data parameter No.183 BIT0(MZRX) , BIT1(MZRZ) , BIT2(MZRY) , BIT3(MZR4) , BIT4(MZR5) =0

BIT 0 ~ BIT 4 of diagnosis message DGN.000 are used to check the validity of zero deceleration signal.

## 4.6 Spindle Adjustment

### 4.6.1 Spindle encoder

Encoder with the pulses 100~5000p/r is needed to be installed on the machine for threading. The pulses are set by data parameter No.70. The transmission ratio(spindle gear teeth/encoder gear teeth) between encoder and spindle is 1/255~255. The spindle gear teeth are set by CNC data parameter No.110, and the encoder gear teeth are set by data parameter No.111.

Synchronous belt transmission should be applied for it (no sliding transmission).

The BIT3 of diagnosis message DGN.008 are used to check the validity of threads number signal of the spindle encoder.

The DGN.011 and DNG.012 of diagnosis message are used to check the validity of thread signal of the spindle encoder.

### 4.6.2 Spindle brake

After M05 code is executed, proper spindle brake time should be set to stop the spindle promptly in order to enhance the machining efficiency. If the brake is employed with energy consumption type, too long braking time may burn out the motor.

Data parameter No.087: delay from spindle stop(M05) to spindle brake output

Data parameter No.089: spindle braking time

### 4.6.3 Switch volume control of spindle speed

When the machine is controlled by a multi-speed motor, the motor speed codes are S01~S04. The relevant parameters are as follows:

State parameter No.001 Bit4=0: select spindle speed switch control;

### 4.6.4 Analog voltage control of spindle speed

This function can be obtained by the parameter setting of CNC. By interface outputting 0V~10V analog voltage to control frequency inverter, the stepless shift can be obtained. And the related parameters needed to be adjusted are:

Bit parameter No.001 Bit4=1: for spindle speed analog voltage control;

Data parameter No.021: offset value as spindle speed code voltage is 10V;

Data parameter No.036: offset value as spindle speed code voltage is 0V;

Data parameter No.037~ No.040: for max. speed clamping of spindle gear 1~4; it defaults the spindle gear 1 when CNC power on.

Basic parameters are needed to adjust the inverter:

CW or CCW code mode selection: it is determined by terminal VF;

Frequency setting mode selection: it is determined by terminal FR;

If the speed by programming is not consistent with that detected by the encoder, it can be adjusted to be consistent with the actual one by adjusting the data parameter No.037~No.040.

Speed adjustment method: select the corresponding spindle gear, determine the data parameter is 9999 as for this system gear, set the spindle override for 100%. Input spindle run command in MDI mode to run the spindle: M03/M04 S9999, view the spindle speed shown on the right bottom of the screen, then input the speed value displayed into the corresponding system parameter.

When entering S9999 code, the voltage should be 10V, S0 for 0V. If there is a voltage error, adjust bit parameter No.021 and No.036 to correct the voltage offset value (corrected by manufacturer, usually not needed).

For the current max. speed gear, if the analog voltage output by CNC is not 10V, set it for 10V by adjusting the data parameter No.021; when the input speed is 0, if the spindle still slowly rotates, it means the analog voltage output by CNC is higher than 0V, so set a smaller value for data parameter No.036.

If the machine is not fixed with an encoder, the spindle speed can be detected by a speed sensing instrument, input S9999 in MDI mode to set the speed value displayed by the instrument into the data parameter No.037~ No.040.

## 4.7 Backlash Offset

The X axis backlash offset value is input by diameter, Z axis backlash offset value is input by the actual backlash which can be measured by a dial-indicator, a micrometer or a laser detector. Because the backlash offset can improve the machining precision only by accurate compensation, it is not recommended to measure it in MPG or Step mode, but the following method is suggested:

- Program editing (taking example of Z):

```
O0001;
```

```
N10 G01 W10 F800 ;
```

```
N20 W15;
```

N30 W1;  
 N40 W-1;  
 N50 M30.

- Set the backlash error offset to 0 before measuring;
- Run the program by single blocks, search the measuring benchmark after 2 positioning operations, record the current data, move 1mm in the same direction, then move 1mm to point B reversely, read the current data.

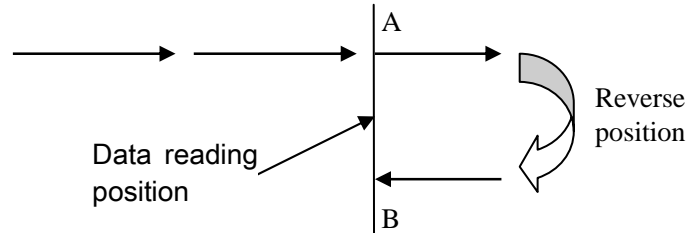

Fig. 4-4 Schematic map of backlash measuring method

- Backlash error offset value= | data of point A –data of point B |; then input its outcome to the data parameter No.034(BKLX) ,No.035(BKLZ) ,No.180(BKLY) ,No.181(BKL4) ,No.182(BKL5) (multiply X axis data to 2 and input the outcome to data parameter No.034).  
 Data A: dial-indicator data at point A  
 Data B: dial-indicator data at point B

Note 1: The backlash offset mode can be set by Bit7 of CNC parameter No.011; the backlash frequency can be set by Bit6 of parameter No.011 and Bit4, Bit3, Bit2, Bit1, Bit0 of bit parameter No.010.

Note 2: Check the machine backlash every 3 months.

## 4.8 Tool Post Debugging

GSK980TDc supports various kinds of tool post, and the parameter settings are based on the machine manual. The parameter settings for the tool post running are as follows:

BIT2(TSGN) of K parameter No.011: high/low level selection of tool post in-position signal, when the signal is low level active, a parallel pull-up resistor is needed.

Bit3 (CTCP) of K parameter No.011: check/do not check tool post lock signal in tool change;

Bit4 (TCPS)of K parameter No.011: tool post lock signal HIGH/LOW selection;

Bit5 (CHET) of K parameter No.11: check/do not check tool signal;

Combinations and functions of tool change mode selection Bit1(CHTB), Bit0(CHTA) of K parameter No.11 are referred to **Tool Change Control**.

Data parameter No.076: Duration for moving a tool in tool changing

Data parameter No.078: Upper limit time for changing one tool

Data parameter No.082: Delay time from tool post CCW stop to CW clamping start

Data parameter No.084: Total tools number

Data parameter No.085: Delay of tool post CW clamping

If the tool post doesn't rotate at first power on for tool change, the phase connection of the 3-phase power of the tool post motor may be incorrect, it needs to press the RESET key immediately and cutoff the power, then check the wiring; if the fault is caused by this, exchange two phases of the 3-phase power.



The CW clamping duration setting should be proper, it should be neither longer nor shorter, longer delay may damage the motor, shorter delay may cause the tool post not to be completely clamped. The method to check the tool post clamping is: approach the dial-indicator to the tool post, turn the tool post manually, and the pointer floating of the dial-indicator should not be over 0.01mm.

The BIT7(TL-) and BIT6(TL+) of diagnosis message DGN.005 are used to check the validity of tool post CCW/CW output signal.

The BIT0~BIT3 (T01~T04) of diagnosis message DGN.000 are used to check the validity of tool number T01~T04 signal.

During debugging, every tool, max. tools change should be performed to check the correctness of the tool change, time parameter setting.

### 4.9 Step/MPG Adjustment



The  key on the panel can be used to select the Step mode or MPG mode, which is set by the BIT3 of bit parameter No.001.

Bit3 =1: MPG mode active, Step mode inactive;

=0: Step mode active, MPG mode inactive;

## CHAPTER 5 DIAGNOSIS MESSAGE

Diagnosis messages for GSK980TDc system are described in this chapter.

### 5.1 CNC Diagnosis

The part is used to check the CNC interface signals and internal running and it can't be modified.

#### 5.1.1 I/O status and data diagnosis message

0   0   0	ESP	***	***	DEC5	DEC4	DECZ	DECY	DECX
Pin	CN61.6			CN61.34	CN61.33	CN61.12	CN61.32	CN61.4
PLC fixed address	X0.5			X2.5	X2.4	X1.3	X2.3	X0.3

DECX, DECY, DECZ, DEC4, DEC5: machine zero return signal of X, Y, Z, 4th, 5th

ESP: emergency stop signal

0   0   1	***	***	***	***	***	***	***	SKIP
Pin								CN61.42
PLC fixed address								X3.5

SKIP: skip signal

#### 5.1.2 CNC motion state and data diagnosis message

0   0   3	***	***	***	RDY5	RDY4	RDYZ	RDYY	RDYX
-----------	-----	-----	-----	------	------	------	------	------

RDY5~RDYX: X, Y, Z, 4th, 5<sup>th</sup> ready signal

0   0   4	***	***	***	EN5	EN4	ENZ	ENY	ENX
-----------	-----	-----	-----	-----	-----	-----	-----	-----

EN5~ENX: enabling signal

0   0   5	***	***	***	SET5	SET4	SETZ	SETY	SETX
-----------	-----	-----	-----	------	------	------	------	------

SET5~SETX: pulse prohibit signal

0   0   6	***	***	***	DRO5	DRO4	DROZ	DROY	DROX
-----------	-----	-----	-----	------	------	------	------	------

DRO5~DROX: X, Y, Z, 4th, 5<sup>th</sup> motion direction output

0   0   8	***	***	***	PC5	PC4	PCZ	PCY	PCX
-----------	-----	-----	-----	-----	-----	-----	-----	-----

PC5~PCX: X, Y, Z, 4th, 5<sup>th</sup> zero signal

0   0   9	***	***	***	ALM5	ALM4	ALMZ	ALMY	ALMX
-----------	-----	-----	-----	------	------	------	------	------

ALM5~ALMX: X, Y, Z, 4th, 5<sup>th</sup> alarm signal

0   1   0	MPG rotation data							
-----------	-------------------	--	--	--	--	--	--	--

0	1	1	Spindle speed feedback data
0	1	2	Spindle speed maximum feedback data
0	1	3	Spindle 1 analog output value
0	1	4	Spindle 2 analog output value
0	4	8	X axis output pulse number
0	4	9	X axis actual output pulse number (FPGA actual output)
0	5	0	Y axis output pulse number
0	5	1	Y axis actual output pulse number (FPGA actual output)
0	5	2	Z axis output pulse number
0	5	3	Z axis actual output pulse number (FPGA actual output)
0	5	4	4 <sup>th</sup> axis output pulse number
0	5	5	4 <sup>th</sup> axis actual output pulse number (FPGA actual output)
0	5	6	5 <sup>th</sup> axis output pulse number
0	5	7	5 <sup>th</sup> axis actual output pulse number (FPGA actual output)
0	6	7	Spindle encoder counting
0	6	8	MPG counting
0	6	9	The pulse number from the time that X axis starts detecting PC signal to PC signal is detected
0	7	0	The pulse number from the time that Y axis starts detecting PC signal to PC signal is detected
0	7	1	The pulse number from the time that Z axis starts detecting PC signal to PC signal is detected
0	7	2	The pulse number from the time that 4 <sup>th</sup> axis starts detecting PC signal to PC signal is detected
0	7	3	The pulse number from the time that 5 <sup>th</sup> axis starts detecting PC signal to PC signal is detected
0	7	4	The times of system powering off
0	7	5	The times of system undervoltage (when the power is not off)
0	7	6	The times of insufficient time for data saving when the system is undervoltage

### 5.1.3 Diagnosis keys

DGN.016~DGN.022 are the diagnosis messages of edit keypad keys; DGN.024~DGN.029 are the diagnosis messages of machine operation panel keys. When pressing a key in the operation panel, the corresponding bit displays “1”, and “0” after releasing this key. If it displays reversely, it means there is a fault in the keypad circuit.

0	1	6
Key		

RST	O	N	G	P/Q	7	8	9

0	1	7
Key		

PGU	X	Z	U	W	4	5	6

0	1	8
Key		

PGD	H/Y	F/E	R/V	D/L	1	2	3

0	1	9
---	---	---

CRU	RIGHT	I/A	J/B	K/C	-	0	.
-----	-------	-----	-----	-----	---	---	---

Key			I <sub>A</sub>	J <sub>B</sub>	K <sub>C</sub>	- + └ ┘	○	· < >
0 2 0 Key	CRD 	LEFT 	M M <sub>t</sub>	S S <sub>j</sub>	T T <sub>=</sub>	EOB	INS/ALT INSERT ALTER	DEL DELETE
0 2 1 Key	IN DATA INPUT	OUT DATA OUTPUT	CHG CHANGE	/, # / * #	CAN CANCEL			
0 2 2 Key	POS POSITION	RPG PROGRAM	OFT OFFSET	ALM ALARM	SET SETTING	PAR PARAMETER	DGN DIAGNOSIS	GRA GRAPH
0 2 3 Key	FLEFT 	F1	F2	F3	F4	F5	FRIGHT 	PLC PLC

### 5.1.4 Others

0	7	1
1	1	8
1	1	9

BOOT version No.
PLC execution time(ms)
Execution all time (h)

0 2 1 Key	IN DATA INPUT	OUT DATA OUTPUT	CHG CHANGE	/, # / * #	CAN CANCEL			
0 2 2 Key	POS POSITION	RPG PROGRAM	OFT OFFSET	ALM ALARM	SET SETTING	PAR PARAMETER	DGN DIAGNOSIS	GRA GRAPH
0 2 3 Key	FLEFT 	F1	F2	F3	F4	F5	FRIGHT 	PLC PLC

## 5.2 PLC State

This part of diagnosis is used to detect the signal state of machine→PLC(X), PLC→machine(Y), CNC→PLC (F), PLC→CNC (G) and alarm address A, and internal relay (R, K) states.

### 5.2.1 X address (machine→PLC , defined by standard PLC ladders)

<b>X0000</b>	T05	PRES	ESP	DITW	DECX	DIQP	SP	SAGT
--------------	-----	------	-----	------	------	------	----	------

- T05: tool signal T05
- PRES: pressure check input signal
- ESP: emergency stop signal
- DITW: tailstock control input

DECX: X deceleration signal  
 DIQP: chuck control input  
 SP: external pause  
 SAGT: safety door check signal

<b>X0001</b>	T01	M42I	M41I	ST	DECZ	T08/CHOT	T07/INDX	T06/SELE
--------------	-----	------	------	----	------	----------	----------	----------

T01: tool signal T01  
 M42I: spindle automatic gear shifting 2-gear in-position signal  
 M41I: spindle automatic gear shifting 1-gear in-position signal  
 ST: external cycle start  
 DECZ: Z deceleration signal  
 T08/CHOT: tool signal T08/tool post worktable overheat  
 T07/INDX: tool signal T07/Yantai tool post pregraduation input  
 T06/SELE: tool signal T06/Yantai tool post strobe signal

<b>X0002</b>	AEY/BDT	TCP	DEC5	DEC4	DECY	T04	T03	T02
--------------	---------	-----	------	------	------	-----	-----	-----

AEY/BDT: external skip  
 TCP: tool post clamp signal  
 DEC5: 5<sup>th</sup> deceleration signal  
 DEC4: 4<sup>th</sup> deceleration signal  
 DECY: Y deceleration signal  
 T04: tool signal T04  
 T03: tool signal T03  
 T02: tool signal T02

<b>X0003</b>	AEZ	AEX	SKIP	NQPJ	WQPJ	LMIZ	LMIY	LMIX
--------------	-----	-----	------	------	------	------	------	------

AEZ: G37 skip signal  
 AEX: G36 skip signal  
 SKIP: G31 skip signal  
 NQPJ: inner chuck clamp/outer chuck clamp in-position signal  
 WQPJ: inner chuck release/outer chuck clamp in-position signal  
 LMIZ: Z overtravel input  
 LMIY: Y overtravel input  
 LMIX: X overtravel input

<b>X0005</b>	***	***	***	***	SALM	COIN	SAR	VPO
--------------	-----	-----	-----	-----	------	------	-----	-----

SALM: spindle abnormality alarm input  
 COIN: spindle orientation completion signal  
 SAR: spindle speed arrival  
 VPO: spindle position/speed control state

<b>X0006</b>	***	***	×100	×10	×1	ZHAN	YHAN	XHAN
--------------	-----	-----	------	-----	----	------	------	------

×100: increment ×100 (external)  
 ×10: increment ×10 (external)  
 ×1: increment ×1 (external)  
 ZHAN: Z selection (external)  
 YHAN: Y selection (external)

XHAN: X selection (external)

### 5.2.2 Y address (PLC→machine, defined by standard PLC ladders)

<b>Y0000</b>	SPZD	SCLP	M05	M04	M03	***	M32	COOL
--------------	------	------	-----	-----	-----	-----	-----	------

SPZD: spindle brake  
 SCLP: spindle clamped  
 M05: spindle stop  
 M04: spindle rotation CCW  
 M03: spindle rotation CW  
 M32: lubricating output  
 COOL: cooling output

<b>Y0001</b>	TL-	TL+	DOQPS	DOQPJ	S4/M44	S3/M43	S42/M42	S41/M41
--------------	-----	-----	-------	-------	--------	--------	---------	---------

TL-: TL-tool post rotation (CW)  
 TL+: TL+tool post rotation(CCW)  
 DOQPS: chuck release  
 DOQPJ: chuck clamp  
 S4/M44: spindle mechanical 4-gear  
 S3/M43: spindle mechanical 3-gear  
 S2/M42: spindle mechanical 2-gear  
 S1/M41: spindle mechanical 1-gear

<b>Y0002</b>	VP2	DOTWS	DOTWJ	CLPR	CLPG	CLPY	INDXS	TZD
--------------	-----	-------	-------	------	------	------	-------	-----

VP2: the 2<sup>nd</sup> spindle speed/position switch output  
 DOTWS: tailstock going backward  
 DOTWJ: tailstock going forward  
 CLPR: three-color lamp-red  
 CLPG: three-color lamp-green  
 CLPY: three-color lamp-yellow  
 INDXS: tool post worktable pregraduation coil  
 TZD: tool post worktable brake

<b>Y0003</b>	UO5/SP2	UO4/SP1	UO3/SP0	U2/M64/STAO	U1/M63	U0/TAP2	HPS T	SVF
--------------	---------	---------	---------	-------------	--------	---------	----------	-----

UO5/SP2: user macro output 5 / orientation position 2  
 UO4/SP1: user macro output 4 / orientation position 1  
 UO3/SP0: user macro output 3 / orientation position 0  
 U2/M64/STAO: user macro output 2/the 2<sup>nd</sup> spindle CCW/orientation start signal  
 U1/M63: user macro output 1/the 2<sup>nd</sup> spindle CW  
 U0/TAP2: user macro output 0/the 2<sup>nd</sup> gain selection signal of the 2<sup>nd</sup> spindle speed loop(rigid tapping)  
 HPST: hydraulic control output  
 SVF: spindle servo OFF (reduce the spindle servo excitation)

<b>Y0005</b>	***	***	***	***	SRV	SFR	TAP	VP
--------------	-----	-----	-----	-----	-----	-----	-----	----

SRV: spindle rotation(CW)

SFR: spindle rotation(CCW)  
TAP: the 2<sup>nd</sup> gain selection signal of the spindle speed loop  
VP: spindle position / speed control switch output

5.2.3 Machine panel

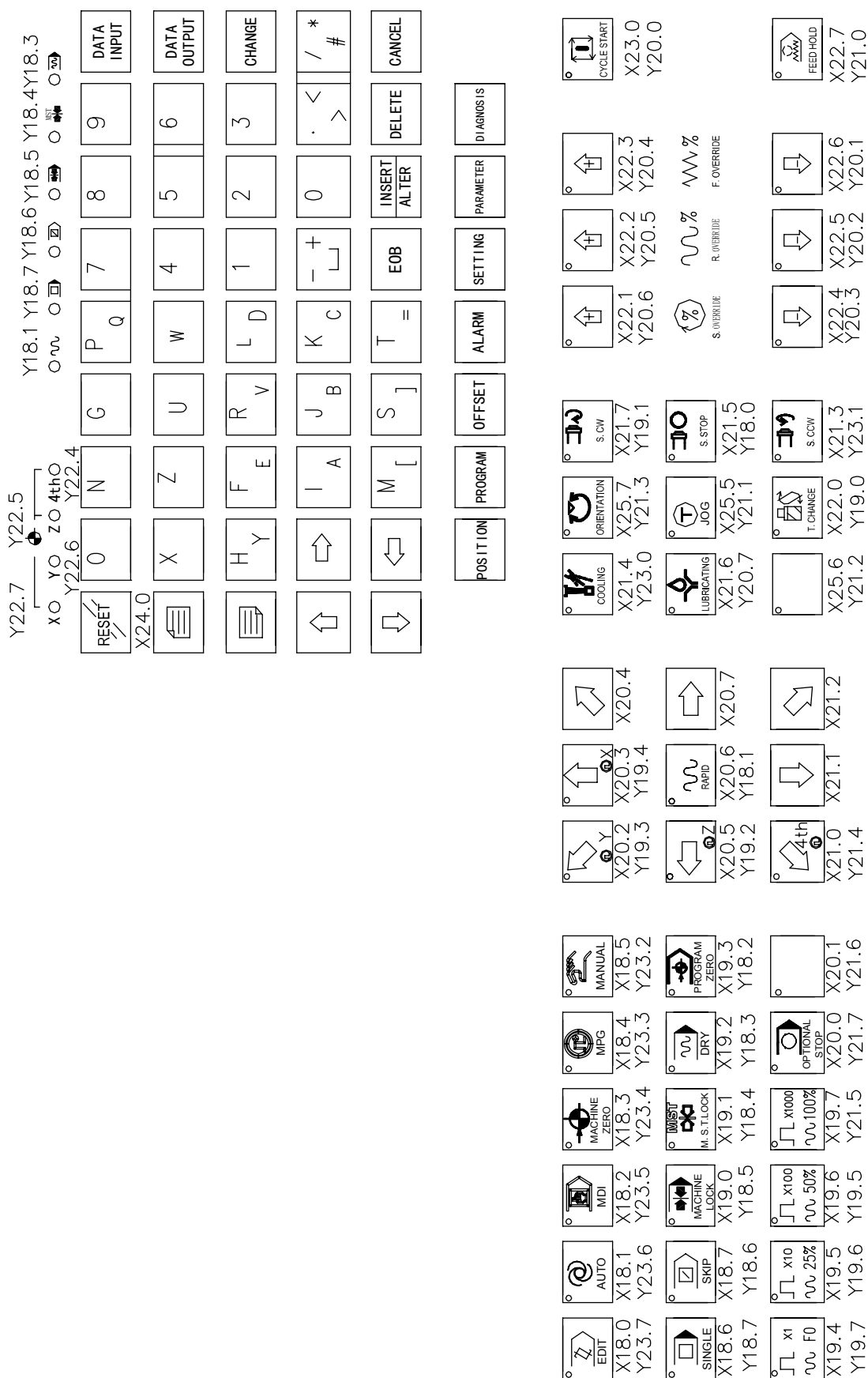

GSK980TDC machine panel





### 5.2.4 F address(CNC→PLC)

<b>F000</b>	OP	SA	STL	SPL	***	***	***	RWD
-------------	----	----	-----	-----	-----	-----	-----	-----

- OP: Auto run signal
- SA: Servo ready signal
- STL: Cycle start indicator signal
- SPL: Feed hold indicator signal

<b>F001</b>	MA	***	TAP	ENB	DEN	***	RST	AL
-------------	----	-----	-----	-----	-----	-----	-----	----

- MA: CNC ready signal
- TAP: Tapping signal
- ENB: Spindle enable signal
- DEN: Designation end signal
- RST: Reset signal
- AL: Alarm signal

<b>F002</b>	MDRN	CUT	***	SRNMV	THRD	CSS	RPDO	INCH
-------------	------	-----	-----	-------	------	-----	------	------

- MDRN: Dry run detection signal
- CUT: Cutting feed signal
- SRNMV: Program start signal
- THRD: Threading signal
- CSS: Constant surface speed signal
- RPDO: Rapid feed signal
- INCH: Inch input signal

<b>F003</b>	***	MEDT	MMEM		MMDI	MJ	MH	MINC
-------------	-----	------	------	--	------	----	----	------

- MEDT: Memory edit selection detection signal
- MMEM: Auto run selection detection signal
- MMDI: MDI selection detection signal
- MJ: JOG selection detection signal
- MH: MPG selection detection signal
- MINC: Increment feed detection signal

<b>F004</b>	***	MPST	MREF	MAFL	MSBK	MABSM	MMLK	MBDT1
-------------	-----	------	------	------	------	-------	------	-------

- MPST: Program beginning return detection signal
- MREF: Manual reference return detection signal
- MAFL: MST lock detection signal
- MSBK: Single block detection signal
- MABSM: JOG absolute detection signal
- MMLK: All machine axes lock detection signal
- MBDT1: Optional block skip detection signal

<b>F007</b>	***	***	***	***	TF	SF	***	MF
-------------	-----	-----	-----	-----	----	----	-----	----

- TF: Tool function strobe signal
- SF: Spindle speed strobe signal
- MF: MST function strobe signal

<b>F0009</b>	DM00	DM01	DM02	DM30	***	***	***	***
--------------	------	------	------	------	-----	-----	-----	-----

DM00: M decoding signal

DM01: M decoding signal

DM02: M decoding signal

DM30: M decoding signal

<b>F0010</b>	MB07	MB06	MB05	MB04	MB03	MB02	MB01	MB00
<b>F0011</b>	MB15	MB14	MB13	MB12	MB11	MB10	MB09	MB08
<b>F0012</b>	MB23	MB22	MB21	MB20	MB19	MB18	MB17	MB16
<b>F0013</b>	MB31	MB30	MB29	MB28	MB27	MB26	MB25	MB24

Miscellaneous function codes MB00~MB31

<b>F0022</b>	SB07	SB06	SB05	SB04	SB03	SB02	SB01	SB00
<b>F0023</b>	SB15	SB14	SB13	SB12	SB11	SB10	SB09	SB08
<b>F0024</b>	SB23	SB22	SB21	SB20	SB19	SB18	SB17	SB16
<b>F0025</b>	SB31	SB30	SB29	SB28	SB27	SB26	SB25	SB24

Spindle speed code signal SB00~SB31

<b>F0026</b>	TB07	TB06	TB05	TB04	TB03	TB02	TB01	TB00
<b>F0027</b>	TB15	TB14	TB13	TB12	TB11	TB10	TB09	TB08
<b>F0028</b>	TB23	TB22	TB21	TB20	TB19	TB18	TB17	TB16
<b>F0029</b>	TB31	TB30	TB29	TB28	TB27	TB26	TB25	TB24

Tool function code signal TB00~TB31

<b>F0036</b>	R08O	R07O	R06O	R05O	R04O	R03O	R02O	R01O
<b>F0037</b>	***	***	***	***	R12O	R11O	R10O	R09O

S12 bit code signal R010~R12O

<b>F0054</b>	UO07	UO06	UO05	UO04	UO03	UO02	UO01	UO00
<b>F0055</b>	UO15	UO14	UO13	UO12	UO11	UO10	UO09	UO08

Macro output signal UO00~UO15

<b>F0056</b>	U107	U106	U105	U104	U103	U102	U101	U100
<b>F0057</b>	U115	U114	U113	U112	U111	U110	U109	U108
<b>F0058</b>	U123	U122	U121	U120	U119	U118	U117	U116
<b>F0059</b>	U131	U130	U129	U128	U127	U126	U125	U124

Macro output signal U100~131

<b>F0064</b>	***	***	***	***	***	***	TLNW	TLCH
--------------	-----	-----	-----	-----	-----	-----	------	------

TLNW: New tool selection signal (for tool life management)

TLCH: Tool change signal(for tool life management)

<b>F0065</b>	***	***	***	***	***	***	RGSPM	RGSPP
--------------	-----	-----	-----	-----	-----	-----	-------	-------

RGSPM: Spindle CCW rotation (in rigid tapping)

RGSPP: Spindle CW rotation (in rigid tapping)

<b>F0076</b>	***	***	***	***	RTAP	***	***	***
--------------	-----	-----	-----	-----	------	-----	-----	-----

RTAP: rigid tapping method signal

<b>F0091</b>	***	***	***	***	MMMOD	***	***	***
--------------	-----	-----	-----	-----	-------	-----	-----	-----

MMMOD: Mode signal; it informs system of the manual trial cut mode;

<b>F0094</b>	***	***	***	ZP5	ZP4	ZP3	ZP2	ZP1
--------------	-----	-----	-----	-----	-----	-----	-----	-----

- ZP5: Reference point return end signal ZP5
- ZP4: Reference point return end signal ZP4
- ZP3: Reference point return end signal ZP3
- ZP2: Reference point return end signal ZP2
- ZP1: Reference point return end signal ZP1

<b>F0102</b>	***	***	***	MV5	MV4	MV3	MV2	MV1
--------------	-----	-----	-----	-----	-----	-----	-----	-----

- MV5: Axis move signal MV5
- MV4: Axis move signal MV4
- MV3: Axis move signal MV3
- MV2: Axis move signal MV2
- MV1: Axis move signal MV1

<b>F0106</b>	***	***	***	MVD5	MVD4	MVD3	MVD2	MVD1
--------------	-----	-----	-----	------	------	------	------	------

- MVD5: Axis move direction signal MVD5
- MVD4: Axis move direction signal MVD4
- MVD3: Axis move direction signal MVD3
- MVD2: Axis move direction signal MVD2
- MVD1: Axis move direction signal MVD1

<b>F0120</b>	***	***	***	ZRF5	ZRF4	ZRF3	ZRF2	ZRF1
--------------	-----	-----	-----	------	------	------	------	------

- ZRF5: Reference point creation signal ZRF5
- ZRF4: Reference point creation signal ZRF4
- ZRF3: Reference point creation signal ZRF3
- ZRF2: Reference point creation signal ZRF2
- ZRF1: Reference point creation signal ZRF1

<b>F0129</b>	***	***	***	***	***	***	***	KEAXSL
--------------	-----	-----	-----	-----	-----	-----	-----	--------

- KEAXSL: PLC axis control status selection signal

<b>F0130</b>	EBSYA	***	***	EGENA	EDENA	***	***	***
--------------	-------	-----	-----	-------	-------	-----	-----	-----

- EBSYA: PLC axis control group A command read completed signal
- EGENA: PLC axis control group A axis movement signal
- EDENA: PLC axis control group A auxiliary function implement signal

<b>F0131</b>	***	***	***	***	***	***	EABUFA	EMFA
--------------	-----	-----	-----	-----	-----	-----	--------	------

- EABUFA: PLC axis control group A buffer full signal
- EMFA: PLC axis control group A auxiliary function strobe signal

<b>F0132</b>	EM28A	EM24A	EM22A	EM21A	EM18A	EM14A	EM12A	EM11A
--------------	-------	-------	-------	-------	-------	-------	-------	-------

- PLC axis control group A auxiliary function code signals EM11A~EM28A

<b>F0133</b>	EBSYB	***	***	EGENB	EDENB	***	***	***
--------------	-------	-----	-----	-------	-------	-----	-----	-----

- EBSYB: PLC axis control group B command read completed signal
- EGENB: PLC axis control group B axis movement signal
- EDENB: PLC axis control group B auxiliary function implement signal

<b>F0134</b>	***	***	***	***	***	***	EABUFB	EMFB
--------------	-----	-----	-----	-----	-----	-----	--------	------

- EABUFB: PLC axis control group B buffer full signal
- EMFB: PLC axis control group B auxiliary function strobe signal

<b>F0135</b>	EM28B	EM24B	EM22B	EM21B	EM18B	EM14B	EM12B	EM11B
PLC axis control group A auxiliary function code signals EM11B~EM28B								
<b>F0136</b>	EBSYC	***	***	EGENC	EDENC	***	***	***
EBSYC: PLC axis control group C command read completed signal EGENC: PLC axis control group C axis movement signal EDENC: PLC axis control group C auxiliary function implement signal								
<b>F0137</b>	***	***	***	***	***	***	EABUFC	EMFC
EABUFC: PLC axis control group C buffer full signal EMFC: PLC axis control group C auxiliary function strobe signal								
<b>F0138</b>	EM28C	EM24C	EM22C	EM21C	EM18C	EM14C	EM12C	EM11C
PLC axis control group A auxiliary function code signals EM11C~EM28C								
<b>F0139</b>	EBSYD	***	***	EGEND	EDEND	***	***	***
EBSYD: PLC axis control group D command read completed signal EGEND: PLC axis control group D axis movement signal EDEND: PLC axis control group D auxiliary implement signal								
<b>F0140</b>	***	***	***	***	***	***	EABUFD	EMFD
EABUFD: PLC axis control group D buffer full signal EMFD: PLC axis control group D auxiliary function strobe signal								
<b>F0141</b>	EM28D	EM24D	EM22D	EM21D	EM18D	EM14D	EM12D	EM11D
PLC axis control group A auxiliary function code signals EM11D~EM28D								
<b>F0142</b>	EM48A	EM44A	EM42A	EM41A	EM38A	EM34A	EM32A	EM31A
PLC axis control group A auxiliary function code signals EM31A~EM48A								
<b>F0145</b>	EM48B	EM44B	EM42B	EM41B	EM38B	EM34B	EM32B	EM31B
PLC axis control group B auxiliary function code signals EM31B~EM48B								
<b>F0148</b>	EM48C	EM44C	EM42C	EM41C	EM38C	EM34C	EM32C	EM31C
PLC axis control group C auxiliary function code signals EM31C~EM48C								
<b>F0151</b>	EM48D	EM44D	EM42D	EM41D	EM38D	EM34D	EM32D	EM31D
PLC axis control group D auxiliary function code EM31D~EM48D								
<b>F0182</b>	***	***	***	EACNT5	EACNT4	EACNT3	EACNT2	EACNT1
EACNT5: PLC axis control 5 <sup>th</sup> axis control signal EACNT4: PLC axis control 4 <sup>th</sup> axis control signal EACNT3: PLC axis control Y axis control signal EACNT2: PLC axis control Z axis control signal EACNT1: PLC axis control X axis control signal								
<b>F0198</b>	***	***	***	PRO5	PRO4	PRO3	PRO2	PRO1
PRO4: Program zero return end signal PRO5 PRO4: Program zero return end signal PRO4 PRO3: Program zero return end signal PRO3 PRO2: Program zero return end signal PRO2 PRO1: Program zero return end signal PRO1								
<b>F0199</b>	***	***	***	***	***	***	***	MSPHD

MSPHD: Spindle JOG detection signal

<b>F0200</b>	***	***	***	SIMSPL	***	***	***	***
--------------	-----	-----	-----	--------	-----	-----	-----	-----

SIMSPL: Analog spindle active

<b>F0201</b>	***	***	DECI	***	***	DCS	***	***
--------------	-----	-----	------	-----	-----	-----	-----	-----

DECI: DEC signal level selection in reference return

DCS: If OUT key may start program in MDI mode

<b>F0205</b>	***	***	***	***	***	ZNIK	***	***
--------------	-----	-----	-----	-----	-----	------	-----	-----

ZNIK: Axis move key hold active in zero return

<b>F0210</b>	***	MST	MSP	***	MESP	***	SINC	SOVI
--------------	-----	-----	-----	-----	------	-----	------	------

MST: Shield external cycle start signal

MSP: Shield external feed hold signal

MESP: Shield external emergency stop signal

<b>F0212</b>	***	***	***	COVL	CINP	CDWL	***	***
--------------	-----	-----	-----	------	------	------	-----	-----

COVL: Bit check being executed

CINP: G04 code being executed

CDWL: RS232 interface being receiving

<b>F0213</b>	***	***	***	***	***	***	CTRD	CTPU
--------------	-----	-----	-----	-----	-----	-----	------	------

CTRD: RS232 interface being transmitting

CTPU: Spindle jog/lubricating selection

<b>F0214</b>	***	***	***	VAL5	VAL4	VALY	ZVAL	XVAL
--------------	-----	-----	-----	------	------	------	------	------

VAL5: 5<sup>th</sup> axis direction selection

VAL4: 4<sup>th</sup> axis direction selection

VALY: Y direction selection

VALZ: Z direction selection

VALX: X direction selection

### 5.2.5 G address (PLC→CNC)

<b>G0004</b>	***	***	***	***	FIN	***	***	***
--------------	-----	-----	-----	-----	-----	-----	-----	-----

FIN: MST function end signal

<b>G0005</b>	***	AFL	***	***	***	***	***	***
--------------	-----	-----	-----	-----	-----	-----	-----	-----

AFL: MST lock signal

SFIN: Spindle S function end signal

<b>G0006</b>	***	SKIPP	***	OVC	***	ABSM	***	SRN
--------------	-----	-------	-----	-----	-----	------	-----	-----

OVC: Feedrate override cancel signal

SRN: Program restart signal

<b>G0007</b>	RLSOT	EXLM	***	***	***	ST	STLK	***
--------------	-------	------	-----	-----	-----	----	------	-----

ST: Cycle start signal

<b>G0008</b>	<b>ERS</b>	<b>RRW</b>	<b>SP</b>	<b>ESP</b>	<b>***</b>	<b>***</b>	<b>***</b>	<b>IT</b>
--------------	------------	------------	-----------	------------	------------	------------	------------	-----------

ERS: External reset signal  
 RRW: Reset and cursor return signal  
 SP: Feed hold signal  
 ESP: Emergency stop signal

<b>G0010</b>	JV07	JV06	JV05	JV04	JV03	JV02	JV01	JV00
<b>G0011</b>	JV15	JV14	JV13	JV12	JV11	JV10	JV09	JV08

JOG override signal JV00~JV15

<b>G0012</b>	<b>FV07</b>	<b>FV06</b>	<b>FV05</b>	<b>FV04</b>	<b>FV03</b>	<b>FV02</b>	<b>FV01</b>	<b>FV00</b>
--------------	-------------	-------------	-------------	-------------	-------------	-------------	-------------	-------------

Feedrate override signal FV00~FV07

<b>G0014</b>	<b>***</b>	<b>***</b>	<b>***</b>	<b>***</b>	<b>***</b>	<b>***</b>	<b>RV2</b>	<b>RV1</b>
--------------	------------	------------	------------	------------	------------	------------	------------	------------

RV2: Rapid feedrate override signal RV2  
 RV1: Rapid feedrate override signal RV1

<b>G0018</b>	<b>***</b>	<b>***</b>	<b>***</b>	<b>***</b>	<b>HD</b>	<b>HC</b>	<b>HB</b>	<b>HA</b>
--------------	------------	------------	------------	------------	-----------	-----------	-----------	-----------

HD: MPG feed selection signal (01004th)  
 HC: MPG feed selection signal (01015th)  
 HB: MPG feed selection signal (0011Y)  
 HA: MPG feed selection signal (0001X. 0010Z)

<b>G0019</b>	<b>RT</b>	<b>***</b>	<b>MP2</b>	<b>MP1</b>	<b>***</b>	<b>***</b>	<b>***</b>	<b>***</b>
--------------	-----------	------------	------------	------------	------------	------------	------------	------------

RT: Manual rapid feed selection signal  
 MP2: MPG override signal MP2  
 MP1: MPG override signal MP1

<b>G0027</b>	<b>CON</b>	<b>***</b>	<b>***</b>	<b>SSTP2</b>	<b>SSTP1</b>	<b>***</b>	<b>SWS2</b>	<b>SWS1</b>
--------------	------------	------------	------------	--------------	--------------	------------	-------------	-------------

CON: Cs contouring control switch signal  
 SSTP2: 2<sup>nd</sup> spindle stop signal (for multi-spindle function)  
 SSTP1: 1<sup>st</sup> spindle stop signal (for multi-spindle function)  
 SWS2: Multi-spindle selection signal 2  
 SWS1: Multi-spindle selection signal 1

<b>G0028</b>	<b>***</b>	<b>***</b>	<b>***</b>	<b>***</b>	<b>***</b>	<b>GR2</b>	<b>GR1</b>	<b>***</b>
--------------	------------	------------	------------	------------	------------	------------	------------	------------

GR2: Gear selection signal  
 GR1: Gear selection signal

<b>G0029</b>	<b>***</b>	<b>KSSTP</b>	<b>***</b>	<b>SAR</b>	<b>***</b>	<b>***</b>	<b>***</b>	<b>***</b>
--------------	------------	--------------	------------	------------	------------	------------	------------	------------

KSSTP: spindle stop signal  
 SAR: spindle speed arrival  
 GR22: 2<sup>nd</sup> spindle gear selection signal 2 (for multi-spindle function)  
 GR21: 2<sup>nd</sup> spindle gear selection signal 1 (for multi-spindle function)

<b>G0030</b>	<b>SOV7</b>	<b>SOV6</b>	<b>SOV5</b>	<b>SOV4</b>	<b>SOV3</b>	<b>SOV2</b>	<b>SOV1</b>	<b>SOV0</b>
--------------	-------------	-------------	-------------	-------------	-------------	-------------	-------------	-------------

SOV7: 2nd Spindle override signal SOV7  
 SOV6: 2nd Spindle override signal SOV6

- SOV5: 2nd Spindle override signal SOV5
- SOV4: 2nd Spindle override signal SOV4
- SOV3: 1st Spindle override signal SOV3
- SOV2: 1st Spindle override signal SOV2
- SOV1: 1st Spindle override signal SOV1
- SOV0: 1st Spindle override signal SOV0

<b>G0032</b>	<b>R08I</b>	<b>R07I</b>	<b>R06I</b>	<b>R05I</b>	<b>R04I</b>	<b>R03I</b>	<b>R02I</b>	<b>R01I</b>
--------------	-------------	-------------	-------------	-------------	-------------	-------------	-------------	-------------

- R08I: Spindle motor speed code signal R08I
- R07I: Spindle motor speed code signal R07I
- R06I: Spindle motor speed code signal R06I
- R05I: Spindle motor speed code signal R05I
- R04I: Spindle motor speed code signal R04I
- R03I: Spindle motor speed code signal R03I
- R02I: Spindle motor speed code signal R02I
- R01I: Spindle motor speed code signal R01I

<b>G0033</b>	<b>SIND</b>	<b>***</b>	<b>***</b>	<b>***</b>	<b>R12I</b>	<b>R11I</b>	<b>R10I</b>	<b>R09I</b>
--------------	-------------	------------	------------	------------	-------------	-------------	-------------	-------------

- R09I: Spindle motor speed code signal R09I
- R10I: Spindle motor speed code signal R10I
- R11I: Spindle motor speed code signal R11I
- R12I: Spindle motor speed code signal R12I
- SGN: Spindle motor code polarity selection signal
- SIND: Spindle motor speed code selection signal

<b>G0043</b>	<b>ZRN</b>	<b>***</b>	<b>DNC1</b>	<b>***</b>	<b>***</b>	<b>MD4</b>	<b>MD2</b>	<b>MD1</b>
--------------	------------	------------	-------------	------------	------------	------------	------------	------------

- MD1: Current mode selection 1
- MD2: Current mode selection 2
- MD4: Current mode selection 3
- DNC1: DNC selection signal
- ZRN: Current mode selection 4

<b>G0044</b>	<b>HDT</b>	<b>***</b>	<b>***</b>	<b>***</b>	<b>***</b>	<b>***</b>	<b>MLK</b>	<b>BDT</b>
--------------	------------	------------	------------	------------	------------	------------	------------	------------

- BDT: Block skip signal (PLC→CNC)
- MLK: Machine lock signal(PLC→CNC)
- HDT: Manual tool change signal

<b>G0046</b>	<b>DRN</b>	<b>***</b>	<b>***</b>	<b>***</b>	<b>KEY1</b>	<b>***</b>	<b>SBK</b>	<b>***</b>
--------------	------------	------------	------------	------------	-------------	------------	------------	------------

- SBK: Single block signal (PLC→CNC)
- KEY1: Memory protection signal
- DRN: Dry run signal

<b>G0054</b>	<b>UI07</b>	<b>UI06</b>	<b>UI05</b>	<b>UI04</b>	<b>UI03</b>	<b>UI02</b>	<b>UI01</b>	<b>UI00</b>
--------------	-------------	-------------	-------------	-------------	-------------	-------------	-------------	-------------

- UI00: Macro input signal UI00
- UI01: Macro input signal UI01
- UI02: Macro input signal UI02
- UI03: Macro input signal UI03



UI04: Macro input signal UI04  
 UI05: Macro input signal UI05  
 UI06: Macro input signal UI06  
 UI07: Macro input signal UI07

<b>G0055</b>	<b>UI15</b>	<b>UI14</b>	<b>UI13</b>	<b>UI12</b>	<b>UI11</b>	<b>UI10</b>	<b>UI09</b>	<b>UI08</b>
--------------	-------------	-------------	-------------	-------------	-------------	-------------	-------------	-------------

UI08: Macro input signal UI08  
 UI09: Macro input signal UI09  
 UI10: Macro input signal UI10  
 UI11: Macro input signal UI11  
 UI12: Macro input signal UI12  
 UI13: Macro input signal UI13  
 UI14: Macro input signal UI14  
 UI15: Macro input signal UI15

<b>G0061</b>	<b>***</b>	<b>***</b>	<b>RGTSP2</b>	<b>RGTSP1</b>	<b>***</b>	<b>***</b>	<b>***</b>	<b>RGTAP</b>
--------------	------------	------------	---------------	---------------	------------	------------	------------	--------------

RGTAP: Rigid tapping signal  
 RGTSP1: Spindle selection in rigid tapping RGTSP1  
 RGTSP2: Spindle selection in rigid tapping RGTSP2

<b>G0074</b>	<b>***</b>	<b>***</b>	<b>SRVB</b>	<b>SFRB</b>	<b>***</b>	<b>***</b>	<b>***</b>	<b>***</b>
--------------	------------	------------	-------------	-------------	------------	------------	------------	------------

SFRB: Spindle CCW signal in rigid tapping  
 SRVB: Spindle CW signal in rigid tapping

<b>G0100</b>	<b>***</b>	<b>***</b>	<b>***</b>	<b>+J5</b>	<b>+J4</b>	<b>+J3</b>	<b>+J2</b>	<b>+J1</b>
--------------	------------	------------	------------	------------	------------	------------	------------	------------

+J1: Feed axis and direction selection signal +J1  
 +J2: Feed axis and direction selection signal +J2  
 +J3: Feed axis and direction selection signal +J3  
 +J4: Feed axis and direction selection signal +J4  
 +J5: Feed axis and direction selection signal +J5

<b>G0102</b>	<b>***</b>	<b>***</b>	<b>***</b>	<b>-J5</b>	<b>-J4</b>	<b>-J3</b>	<b>-J2</b>	<b>-J1</b>
--------------	------------	------------	------------	------------	------------	------------	------------	------------

-J1: Feed axis and direction selection signal -J1  
 -J2: Feed axis and direction selection signal -J2  
 -J3: Feed axis and direction selection signal -J3  
 -J4: Feed axis and direction selection signal -J4  
 -J5: Feed axis and direction selection signal -J5

<b>G0114</b>	<b>***</b>	<b>***</b>	<b>***</b>	<b>+L5</b>	<b>+L4</b>	<b>+L3</b>	<b>+L2</b>	<b>+L1</b>
--------------	------------	------------	------------	------------	------------	------------	------------	------------

+L1: Axis overtravel signal +L1  
 +L2: Axis overtravel signal +L2  
 +L3: Axis overtravel signal +L3  
 +L4: Axis overtravel signal +L4  
 +L5: Axis overtravel signal +L5

<b>G0116</b>	<b>***</b>	<b>***</b>	<b>***</b>	<b>-L5</b>	<b>-L4</b>	<b>-L3</b>	<b>-L2</b>	<b>-L1</b>
--------------	------------	------------	------------	------------	------------	------------	------------	------------

-L1: Axis overtravel signal -L1

- L2: Axis overtravel signal -L2
- L3: Axis overtravel signal -L3
- L4: Axis overtravel signal -L4
- L5: Axis overtravel signal -L5

<b>G0200</b>	***	***	***	***	***	***	***	<b>SPD</b>
--------------	-----	-----	-----	-----	-----	-----	-----	------------

SPD Spindle jog signal

<b>G0201</b>	<b>NT07</b>	<b>NT06</b>	<b>NT05</b>	<b>NT04</b>	<b>NT03</b>	<b>NT02</b>	<b>NT01</b>	<b>NT00</b>
--------------	-------------	-------------	-------------	-------------	-------------	-------------	-------------	-------------

NT00: Current tool No. NT00  
 NT01: Current tool No. NT01  
 NT02: Current tool No. NT02  
 NT03: Current tool No. NT03  
 NT04: Current tool No. NT04  
 NT05: Current tool No. NT05  
 NT06: Current tool No. NT06  
 NT07: Current tool No. NT07

<b>G0202</b>	<b>NT15</b>	<b>NT14</b>	<b>NT13</b>	<b>NT12</b>	<b>NT11</b>	<b>NT10</b>	<b>NT09</b>	<b>NT08</b>
--------------	-------------	-------------	-------------	-------------	-------------	-------------	-------------	-------------

NT08: Current tool No. NT08  
 NT09: Current tool No. NT09  
 NT10: Current tool No. NT10  
 NT11: Current tool No. NT11  
 NT12: Current tool No. NT12  
 NT13: Current tool No. NT13  
 NT14: Current tool No. NT14  
 NT15: Current tool No. NT15

<b>G0203</b>	<b>NT23</b>	<b>NT22</b>	<b>NT21</b>	<b>NT20</b>	<b>NT19</b>	<b>NT18</b>	<b>NT17</b>	<b>NT16</b>
--------------	-------------	-------------	-------------	-------------	-------------	-------------	-------------	-------------

NT16: Current tool No. NT16  
 NT17: Current tool No. NT17  
 NT18: Current tool No. NT18  
 NT19: Current tool No. NT19  
 NT20: Current tool No. NT20  
 NT21: Current tool No. NT21  
 NT22: Current tool No. NT22  
 NT23: Current tool No. NT23

<b>G0204</b>	<b>NT31</b>	<b>NT30</b>	<b>NT29</b>	<b>NT28</b>	<b>NT27</b>	<b>NT26</b>	<b>NT25</b>	<b>NT24</b>
--------------	-------------	-------------	-------------	-------------	-------------	-------------	-------------	-------------

NT24: Current tool No. NT24  
 NT25: Current tool No. NT25  
 NT26: Current tool No. NT26  
 NT27: Current tool No. NT27  
 NT28: Current tool No. NT28  
 NT29: Current tool No. NT29  
 NT30: Current tool No. NT30  
 NT31: Current tool No. NT31

### 5.2.6 Address A (message display requiry signal, defined by standard PLC ladders)

Address	Alarm No.	Content
A0000.0	1000	Tool change too long
A0000.1	1001	Tool post not in-position alarm as tool change ends
A0000.2	1002	Tool change unfinished alarm
A0000.3	1003	Tool post clamping signal not received
A0000.4	1004	Recheck clamping signal, and clamping signal inactive as tool change ends
A0000.5	1005	Tool change execution is mistaken before power off
A0000.6	1006	Pre-indexing proximity switch not arrived
A0000.7	1007	Tool post overheat alarm
A0001.0	1008	M10 and M11 codes disabled for tailstock function inactive
A0001.1	1009	Run-out disabled in spindle running
A0001.3	1011	Spindle start unallowed as tailstock advancing not detected
A0001.4	1012	Cycle unallowed for cycle start disabled
A0001.5	1013	Spindle start unallowed for spindle enable off
A0001.6	1014	Confirm the tools of tool post (8, 10, 12 tools)
A0002.0	1014	Please reset BIT1, BIT0 of parameter 168 for tool post model
A0002.1	1016	Alarm of safe door not closed
A0002.3	1017	Alarm of chuck low pressure
A0002.4	1019	Chuck released unallowed in spindle running
A0002.5	1020	Clamping in-position signal inactive alarm in spindle running
A0002.6	1021	Spindle start unallowed if chuck clamping in-position signal inactive
A0003.0	1022	Spindle start unallowed for chuck releasing
A0003.0	1024	M12/M13 code disabled as chuck inactive
A0003.1	1025	Has not checked the chuck clamped/released start signal
A0003.3	1027	The tool pot is not released
A0003.4	1028	Has not found the target tool
A0003.5	1029	Has not received tool pot stop and locking start signal
A0003.7	1031	Total tools is more than 4, and the external override cannot be connected
A0004.1	1032	Illegal M code
A0004.2	1033	Spindle jog disabled in non-analog spindle mode
A0004.3	1035	M63, M64 designation error
A0004.4	1036	Spindle gear change time is too long
A0004.5	1037	Spindle speed/position control switch time is too long
A0004.6	1038	The 2nd spindle speed/position control switch time is too long
A0004.7	1039	Spindle position control does not permit the orientation
A0005.0	1040	Spindle orientation time is too long
A0005.1	1041	Alarm for the abnormal spindle servo or frequency converter for abnormality
A0005.2	1042	Alarm for the abnormal 2nd spindle servo or frequency converter
A0005.3	1043	Forbid clamping the spindle when the spindle rotating or feeding

Address	Alarm No.	Content
A0005.4	1044	Spindle is clamped not to rotate or feed
A0007.0	2000	Hydraulic motor is not started
A0007.1	2001	Safety door has been opened
A0007.3	2003	Alarm for the tool pot unlocked

### 5.2.7 K address (K parameter, standard PLC definition)

K	1	0	LMIT	LMIS		JSPD	OVRI	OUTR	RSJG	RRW
---	---	---	------	------	--	------	------	------	------	-----

RRW =1: the cursor returning to the head of the program in any working modes when the system resets is valid;

=0: the cursor returning to the head of the program in edit mode when the system resets is valid

RSJG =1: the spindle lubricating, cooling output keep when the system resets;

=0: the spindle lubricating, cooling output close when the system resets.

OUTR =1: pressing  can start the program run in MDI mode;

=0: pressing  cannot start the program run in MDI mode.

OVRI =1: feedrate override is fixed to 100%;

=0: feedrate override can be adjusted.

JSPD =1: the spindle JOG in any modes are valid;

=0: the spindle JOG in MANUAL, MPG, ZERO RETURN are valid.

LMIS =1: overtravel signal LOW/HIGH alarm of each axis;

=0: overtravel signal LOW/HIGH alarm of each axis.

LMIT =1: overtravel of each axis is valid;

=0: overtravel of each axis is invalid.

K	1	1	CHOT	***	CHET	TCPS	CTCP	TSGN	CHTB	CHTA
---	---	---	------	-----	------	------	------	------	------	------

CHTA: tool change mode selection bit 0

CHTB: tool change mode selection bit 1 (see table below)

CHTB	CHTA	Tool post type
0	0	Standard tool change mode B
0	1	Standard tool change mode A
1	0	Yantai AK31 series(6, 8,10, 12 tools)
1	1	Liuxin hydraulic tool post (8, 10, 12 tools)

TSGN =0: tool signal HIGH (be connected to +24V) is valid

=1: tool signal HIGH (be not connected to +24V) is valid

CTCP =0: do not check the tool post lock signal

=1: check the tool post lock signal

TCPS =0: tool post lock signal LOW(be not connected to +24V) is valid

=1: tool post lock signal LOW(be connected to +24V) is valid

CHET=0: do check the tool signal when the tool change ends

=1: check the tool signal when the tool change ends

CHOT=0: do not check the tool post overheat  
 =1: check the tool post overheat

<b>K</b>	<b>1</b>	<b>2</b>					<b>CCHU</b>	<b>NYQP</b>	<b>SLSP</b>	<b>SLQP</b>
----------	----------	----------	--	--	--	--	-------------	-------------	-------------	-------------

SLQP =1: chuck control function is valid;

=0: chuck control function is invalid.

SLSP =1: when the chuck function is valid, the system does not check whether the chuck is clamped;

=0: when the chuck function is valid, the system checks whether the chuck is clamped; when the chuck is not clamped and the spindle cannot be started, the system alarms.

NYQP =1: in outer mode, NQPJ is outer chuck release signal, WQPJ is outer clamp signal;

=0: in inner mode, NQPJ is outer chuck clamp signal, WQPJ is outer release signal.

CCHU =1: the system checks the chuck in-position signal, No.002 Bit7 is inner chuck clamp/outer release signal NQPJ, BIT6 is outer clamp/inner release signal WQPJ, the spindle gear shifting in-position signal M411, M421 is invalid.

=0: the system does not check the chuck in-position signal.

<b>K</b>	<b>1</b>	<b>3</b>						<b>SPTW</b>	<b>SLTW</b>
----------	----------	----------	--	--	--	--	--	-------------	-------------

SLTW =1: tailstock control function is valid;

=0: tailstock control function is invalid.

SPTW =1: the spindle rotation and the tailstock forward/backward does not interlock, the tailstock can execute the tailstock forward/backward no matter what the spindle is in any states;

=0: the spindle rotation and the tailstock forward/backward interlock. When the spindle rotates, the tailstock does not go backward; when it does not go forward, the spindle must not be started.

<b>K</b>	<b>1</b>	<b>4</b>					<b>SPB4</b>	<b>PB4</b>	<b>SPB3</b>	<b>PB3</b>
----------	----------	----------	--	--	--	--	-------------	------------	-------------	------------

PB3 =0: pressure low check function is invalid;

=1: pressure low check function is valid.

SPB3 =0: when PRES is connected with +24V, the system alarms for pressure low;

=1: when PRES is not connected with +24V, the system alarms for pressure low.

PB4 =0: safety door check function is invalid;

=1: safety door check function is valid.

SPB4 =0: when SAGT is not connected with +24V, the safety door is closed;

=1: when SAGT is connected with +24V, the safety door is closed.

<b>K</b>	<b>1</b>	<b>5</b>	<b>RCS</b>	<b>RSCS</b>			<b>SHT</b>	<b>AGIM</b>	<b>AGIN</b>	<b>AGER</b>
----------	----------	----------	------------	-------------	--	--	------------	-------------	-------------	-------------

AGER =1: Spindle automatic gearing active

=0: Spindle automatic gearing inactive

AGIN =1: Detect M411, M421 signal when automatically gearing to gear 1, 2

=0: Not detect M411, M421 signal when automatically gearing to gear 1, 2

AGIM =1: M411, M421 signals active when connecting to 0V

=0: M411, M421 signals active when connecting to +24V

SHT =1: the spindle gear power-down memorizes;

=0: the spindle gear power-down does not memorize.

RSCS =1: close the spindle contour control in emergent stop, reset;  
 =0: does not close the spindle contour control in emergent stop, reset  
 RCS =1: Cs function is valid;  
 =0: Cs function is invalid.

K	1	6	SINC					M32A	ROVI	SOVI
---	---	---	------	--	--	--	--	------	------	------

SINC 1: in Step(MPG) mode, ×1000 is invalid, ×1, ×10, ×100 are valid;  
 0: in Step(MPG) mode, ×1, ×10, ×100, ×1000 are valid.  
 SOVI =1: external feedrate override switch is valid;  
 =0: external feedrate override switch is invalid.  
 ROVI =1: external feedrate override is reverse;  
 =0: external feedrate override is not reverse.  
 M32A =1: output the lubricating in starting the system when the automatic lubricating is valid;  
 =0: do not output the lubricating in starting the system when the automatic lubricating is valid.

K	1	7	MSEN	SCLP	SALM2	SALM	SSTP	***	***	***
---	---	---	------	------	-------	------	------	-----	-----	-----

SSTP =0: do not close the analog voltage when the spindle stops;  
 =1: close the analog voltage when the spindle stops.  
 SALM =0: the alarm occurs when the spindle HIGH;  
 =1: the alarm occurs when the spindle HIGH.  
 SALM2=0: the occurs when the 2<sup>nd</sup> spindle HIGH;  
 =1: the occurs when the 2<sup>nd</sup> spindle LOW.  
 SCLP =0: the spindle clamping commands executes the 1<sup>st</sup> spindle clamped, the multi-spindle function is valid;  
 =1: the spindle clamping commands executes the 2<sup>nd</sup> spindle clamped, the multi-spindle function is valid;  
 MSEN =0: the multi-spindle control function is invalid;  
 =1: the multi-spindle control function is invalid.

K	1	8	***	***	***	***	MDOK	MD4	MD2	MD1
---	---	---	-----	-----	-----	-----	------	-----	-----	-----

MDOK =0: the operation mode when power-on again is the one that the system is turned off;  
 =1: the operation mode when power-on is the one specified by MD4, MD2, MD1.

MD4	MD2	MD1	Operation mode when power on
0	0	0	MDI mode
0	0	1	Auto mode
0	1	0	Program zero return
0	1	1	Edit mode
1	0	0	MPG mode
1	0	1	Manual mode
1	1	0	Machine zero return

### 5.3 PLC Data

#### 5.3.1 Timer address T(defined by standard PLC ladders)

Address	Meaning
---------	---------

T0000	Timing the closing previous gear count
T0001	Timing from New gear outputting to FIN
T0002	M3, 4, 5, 8, 9, 10, 11, 32, 33 execution timing
T0004	timing from tool CCW stop to CW start
T0005	timing for tool CW
T0006	S code execution timing
T0007	M01, 02, 30 execution timing
T0008	Having not received alarm time of TCP signal
T0009	Tool rotation(CW) timing
T0010	Timing from the spindle stop to brake output
T0011	Spindle brake output timing
T0012	Spindle jog timing
T0013	timing the lubricating jog output time
T0018	Chuck pulse output timing
T0021	Spindle stop, check operation enabling delay
T0039	M01,02,30 execution timing
T0046	Spindle speed/position switch timing

### 5.3.2 Counter address C(Defined by standard PLC Ladders)

Address	Meaning
C0001	Rapid feedrate override - counting on MDI panel
C0002	Rapid feedrate override + counting on MDI panel
C0004	Feed - counting on MDI panel
C0005	Feed + counting on MDI panel
C0006	Spindle override – counting on MDI panel
C0007	Spindle override + counting on MDI panel
C0016	Manual feed – counting on MDI panel
C0017	Manual feed + counting on MDI panel
C0020	2 resetting counting of tool change unfinished alarm

### 5.3.3 Timer presetting address DT(Defined by standard PLC ladders)

Address	Meaning
DT000	Time for original gear disabling during spindle automatic gear changing (ms)
DT001	Delay time after the changed spindle gear is in position (ms)
DT002	Detection time for low pressure alarm (ms)
DT004	Permit time for tool changing (ms)
DT005	M command execution time (ms)
DT006	S command execution time (ms)
DT007	Delay time for tool post from CW to CCW output (ms)
DT008	Tool post lock signal detection time (ms)
DT009	Tool post CCW rotation lock time (ms)
DT010	Spindle braking delay output time (ms)
DT011	Spindle braking output time (ms)

Address	Meaning
DT012	Spindle JOG time (ms)
DT013	Time for manual lubricating ON (0: time is not limited) (ms)
DT014	Chuck clamping command execution time (ms)
DT015	Chuck unclamping command execution time (ms)
DT016	Interval of automatic lubricating (ms) (can be modified directly)
DT017	Time for automatic lubrication output (ms) (can be modified directly)
DT018	Chuck pulse output width (ms) (can be modified directly)
DT020	Spindle clamping/unclamping time (ms)
DT021	Spindle stop, chuck enable delay time (ms)
DT023	Delay time before spindle motor torque decreases to 0 after spindle starts clamping

### 5.3.4 Counter presetting address DC

Address	Meaning
DC000	Spindle zero-speed output range (r/min)



## CHAPTER 6 MEMORIZING PITCH ERROR COMPENSATION

### 6.1 Function Description

There are more or less precision errors in the pitch of machine axes lead screw, and it will definitely affect the parts machining precision. This GSK980TDc CNC system has the memorizing pitch error offset function that it can accurately compensate the pitch error of the lead screw.

### 6.2 Specification

- 1) The offset is concerned with the offset origin, offset intervals, offset point, mechanical moving direction etc.;
- 2) After performing the machine zero return, take this reference point as the offset origin, and set the offset value into the parameters according to axes offset intervals;
- 3) Points to be compensated: 256 points for each axis
- 4) Axis compensated: X, Y, Z ,4th,5th axis
- 5) Offset range:  $0 \sim \pm 127 \mu\text{m}$  for each offset point
- 6) Offset interval:  $1000 \sim 9999999 \mu\text{m}$ ;
- 7) Offset of point N(N=0,1,2,3,...255) is determined by the mechanical error between point N and point N-1;
- 8) The setting is the same as the CNC parameters input, see II **Operation**.

### 6.3 Parameter Setting

#### 6.3.1 Pitch compensation

Bit parameter

0	0	3			PCOMP				
---	---	---	--	--	-------	--	--	--	--

Bit5=1: Pitch error offset active;

Bit5=0: Pitch error offset inactive;

#### 6.3.2 Pitch error compensation number

Set the maximum pitch error compensation number and the minimum pitch error compensation number of each axis through parameters No.096 and No.097 so that the compensation range can be determined. In a compensation value list, the number that corresponds to machine zero point is called pitch error compensation origin (reference point). The pitch error compensation origin is set by parameter No. 098. It can be any value within the compensation range according to mechanical requirement.

**Data parameter**

0	9	6		PECMINn
---	---	---	--	---------

The maximum pitch error compensation number

0	9	7		PECMAXn
---	---	---	--	---------

The minimum pitch error compensation number

0 9 8

PECORn

The pitch error compensation number that corresponds to machine zero point

### 6.3.3 Pitch error compensation interval

0 9 9

PECINTn

[ Meaning ]

Interval between pitch error compensation point

[ Unit ]

Setting Unit	IS-B	IS-C
Metric machine	0.001 mm	0.0001 mm
Inch machine	0.0001 inch	0.00001 inch

[ Range ]

	IS-B	IS-C
Metric machine	1000~999999	10000~9999999
Inch machine	400~999999	4000~9999999

### 6.3.4 Offset value

The axes pitch offset values are set according to the parameter No. in the following table. The offset value is input by diameter with the input unit 0.001mm, which is irrelevant to diameter or radius programming.

Offset No.	X	Z	Y
000	...	...	...
001	5	-2	3
002	-3	4	-1
...	...	...	...
255	...	...	...

## 6.4 Notes of Offset Setting

- ①The setting and alteration of pitch offset can only be done at the authority of password level 2.
- ②After the parameter of pitch offset is set, only the machine zero is returned could the offset be done.

## 6.5 Setting Examples of Offset Parameters

- ①Data parameter No.099(pitch error origin) =0, Data parameter No.103 (offset interval)=10.000

When the pitch error origin is set to 0:

Assume that the pitch error compensation range is 0~255.

- ①Data parameter No.098 (pitch error origin) =0, Data parameter No.099 (offset interval)=10.000

When the pitch error origin is set to 0:

The offset value for the 1<sup>st</sup> segment is set by the position No.001 in the offset table, the offset value for the 2<sup>nd</sup> segment is set by the position No.002 in the offset table, and the offset value for the Nth segment is set by the position No.000+N in the offset table.

The machine zero is regarded as the reference point of pitch error origin, it begins to compensate

the position No.001 in the offset table from the machine zero. So the pitch error offset can only be done in the positive moving direction of the machine coordinate system.

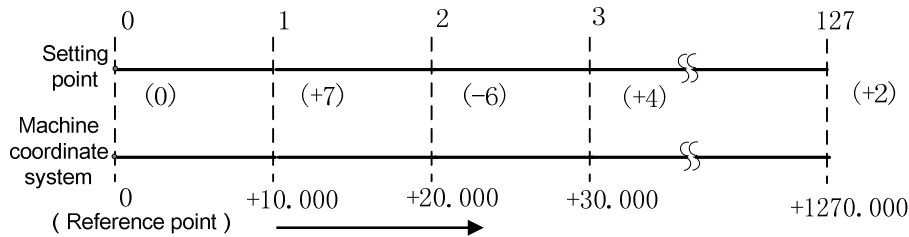

The position No.000 in the offset table corresponds to the reference point (i.e. pitch error origin 0), the offset point 1 corresponds to a point of positive 10.000 moving from this reference point, and a following offset point from this point every 10.000 interval. The 127<sup>th</sup> offset point is the offset at position 1270.000. Therefore, at offset point 1, set a offset value moving from 0 to 10.000, at offset point 2, set a offset value when moving from 10.000 to 20.000. At offset point N, set a offset value when moving from (N-1)×(offset interval) to N×(offset interval).

The following table content is resulted from the above:

Machine coordinate system	Offset parameter No.	Offset value	Drive unit current code pulses before compensating	Drive unit current command pulses after compensating
Reference point 0	000	000	00000	00000
10.000	001	7	10000	10007
20.000	002	-6	20000	20001
30.000	003	4	30000	30005
.....	004	...		

Actually the machine moves from the reference point to the point of +30.000, the pitch error offset is: (+7)+(-6)+(4)=+5

②Data parameter No.099 (pitch error origin) =60, No.103(offset interval) =10.000

When the pitch error origin is set to 60:

For the positive moving, the 1<sup>st</sup> segment error offset is set by position No.061 in the offset table, the 2<sup>nd</sup> segment by position No.062. The Nth segment error offset is set by position No.060+N in the offset table.

For the negative moving, the 1<sup>st</sup> segment error offset is set by position No.060 in the offset table, the 2<sup>nd</sup> segment by position No.059. The Nth segment error offset is set by position No.060-N in the offset table.

The machine zero is taken as the reference point of the pitch error origin, when moving from the positive of machine coordinate system, it begins to compensate by the corresponding position No.061 in the offset table; when moving from the negative of the machine coordinate system, it begins to compensate by the position No.060. Therefore the pitch offset can be done when moving in the positive or the negative axis of machine coordinate system.

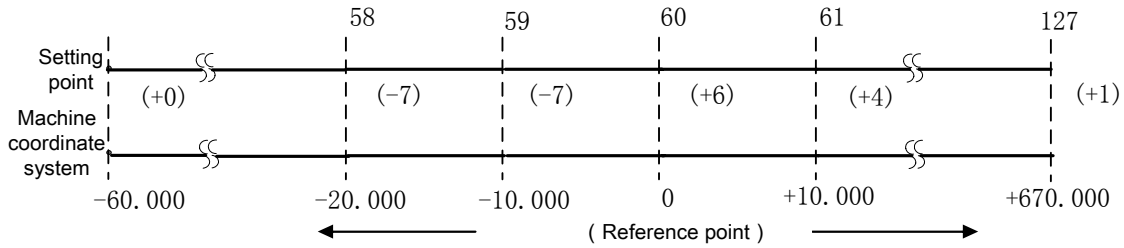

The position No.060 in the offset table corresponds to the reference point (60), position No.061 to a point of positive10.000 move from origin. So there is a offset point every 10.000 from position 61, the 127<sup>th</sup> offset point corresponds to the offset of position +670.000. While the position No.059 corresponds to a point of negative 10.000 move from reference point. Also there is a offset point every 10.000 from position 59, the offset point 0 corresponds to the offset at position -600.000. Therefore the point N is set by a offset of move from  $(N-61) \times (\text{offset interval})$  to  $(N-60) \times (\text{offset interval})$ .

The following table content is resulted from the above:

Machine coordinate system	Offset parameter No.	Offset value	Drive unit current code pulses before compensating	Drive unit current code pulses after compensating
-30.000	058	-7	-30000	-29992
-20.000	059	-7	-20000	-19999
-10.000	060	+6	-10000	-10006
Reference point 0			0	0
10.000	061	+4	10000	10004
.....	062	...		

Actually as the machine moves from point -30.000 to the point +10.000, the pitch error offset is:  $(-7)+(-7)+(+6)+(+4)=(-4)$

③Data parameter No.099 (pitch error origin) =127, No.103 (offset interval) =10.000

When the pitch error origin is set to 127:

The offset value for the 1<sup>st</sup> segment is set by the position No.127 in the offset table, the offset value for the 2<sup>nd</sup> segment is set by the position No.126 in the offset table, and the offset value for the Nth segment is set by the position No.128-N in the offset table.

The machine zero is regarded as the reference point of pitch error origin, it begins to compensate the position No.127 in the offset table from the machine zero. So the pitch error offset can only be done in the negative moving of the machine coordinate system.

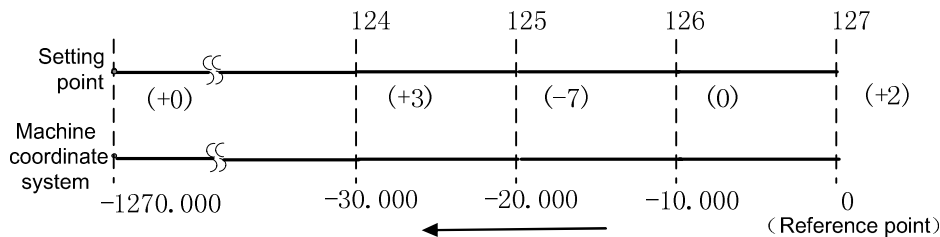

The position No.128 in the offset table corresponds to the reference point (127), the offset point 126 corresponds to a point of negative 10.000 moving from this reference point, then a following

offset point from this point every -10.000 distance. The offset point 1 is the offset at position -1260.000. Therefore, at offset point 127, set a offset value of a moving from 0 to -10.000, at offset point 126, set a offset value of a moving from -10.000 to -20.000. At offset point N, set a offset value of a moving from  $(N-128) \times (\text{offset interval})$  to  $(N-127) \times (\text{offset interval})$ .

Above is the example of the following offset interval error.

Machine coordinate system	Offset parameter number	Offset value	Drive unit current code pulses before compensating	Drive unit current code pulses after compensating
Reference point 0			0	0
-10.000	127	2	10000	10002
-20.000	126	0	20000	20002
-30.000	125	-7	30000	29995
-40.000	124	3	40000	39998

Actually the machine moves from the point -40.000 to the reference point, the pitch error offset is:  
 $(+3)+(-7)+(0)+(+2)=(-2)$ .

